

Quality People. Building Solutions.

Comfort Systems USA (Arkansas), Inc.
P.O. Box 16620
Little Rock, AR 72231
Phone 501-834-3320
Fax 501-834-5416

Date: 1/17/2024

Return Request: 1/27/2024

Project: Academies of Math & Science Little Rock

Supplier: Fluid Solutions

Manufacturer: Various

Submittal: Heat Trace

Submittal Number: 22 01 00-05

Drawing # and Installation: Plumbing Drawings

ARCHITECT

Lewis Architects Engineers
11225 Huron Lane, Suite 104
Little Rock, AR 72211
501-223-9302

ENGINEER

Lewis Architects Engineers
11225 Huron Lane, Suite 104
Little Rock, AR 72211
501-223-9302

GENERAL CONTRACTOR

Clark Contractors
15825 Cantrell Rd.
Little Rock, AR 72223
501-223-9302

MECHANICAL SUBCONTRACTOR

Comfort Systems USA (Arkansas), Inc.
9924 Landers Rd.
N. Little Rock, AR 72117
501-834-3320

Notes:

CSUSA PROJECT NO.

23-1028

jon@comfortar.com

9924 Landers Rd.
No. Little Rock, AR 72117



SUBMITTAL DATA

Date: January 11, 2024
Project: Academies of Math & Science
Contractor: Comfort Systems USA
Engineer: Lewis Architects Engineers

HEAT TRACE

| Item | Quantity | Part | Description |
|------|----------|-------------|--------------------------------------|
| 1 | 650 | HWAT-R2 | 208-277v hot water maintenance cable |
| 2 | 3 | HWAT-ECO-GF | Hot water maintenance controller |
| 3 | 2 | Rayclic-PS | Powered splice kit w/ 2 end seals |
| 4 | 1 | Rayclic-PC | Power connection kit w/ end seal |
| 5 | 5 | Rayclic-T | Tee junction kit w/ end seal |
| 6 | 10 | GT-66 | Glass tape - 66ft |
| 7 | 55 | ETL | Electric trace warning label |

Notes and Considerations: Cable totals based off of top of wall connection. Not dropping down to fixtures. 100' of cable waste for connection points and service loops.

Self-regulating heating cable for hot water temperature maintenance

PRODUCT OVERVIEW

Heating cable construction

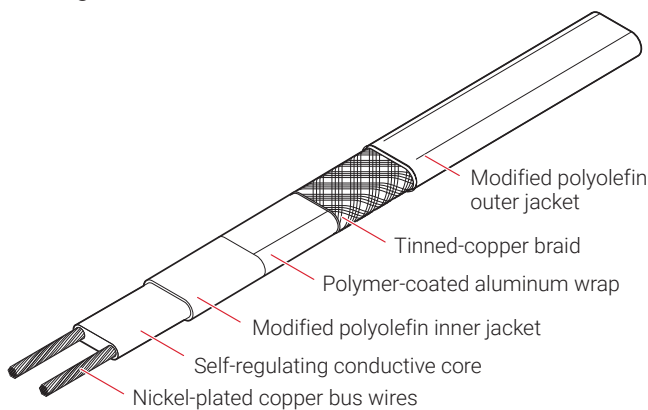

nVent RAYCHEM HWAT self-regulating heating cables are installed on hot water supply pipes underneath standard pipe insulation. The heating cable adjusts its power output to compensate for variations in water temperature and ambient temperature. The heating cable replaces supply-pipe heat losses at the point where the heat loss occurs, thereby providing continuous, energy-efficient, hot water temperature maintenance and eliminating the need for a recirculation system.

Simplified design

Single-pipe nVent RAYCHEM Hot Water Temperature Maintenance Systems (HWAT) eliminate the need for designing complex recirculation systems, with their pumps, piping networks, and complicated flow balancing. Special cases, such as retrofits and multiple pressure zones, are simple to design.

Low installed cost

Installation of the HWAT system is simple. The heating cable can be cut to length, spliced, tee-branched, and terminated at the job site, reducing installation costs. Fewer plumbing components are needed; recirculation piping, pumps, and balancing valves are all eliminated.

Low operating cost

The HWAT system continuously maintains hot water temperature at every point along the supply pipe. Unlike conventional recirculation systems, HWAT systems do not require the overheating of supply water to allow for cooling. The HWAT system reduces the energy requirements of typical hot water systems with reduced heat loss from supply piping, no heat loss from recirculation piping, and no pump to run.

nVent RAYCHEM HWAT-P1 and HWAT-R2 heating cables are designed and approved for operation with the nVent RAYCHEM HWAT-ECO-GF electronic controller. The HWAT-ECO-GF provides flexible temperature control, energy savings, heat-up cycle function, BMS interface, and nine predefined programs that can be customized by the user. The nVent RAYCHEM ACS-30 controller also incorporates the features of the HWAT-ECO-GF for large systems and multiple application control. The ACS-30 only supports HWAT-R2 heating cable for hot water temperature maintenance applications.

SPECIFICATIONS

| | |
|---------------------|-----------------------------|
| Jacket | Modified polyolefin |
| Braid | Tinned copper |
| Bus wires | 16 AWG nickel-plated copper |
| Supply voltage | 120 V, 208–277 V |
| Minimum bend radius | 0.5 in (12 mm) |

PRODUCT CHARACTERISTICS (NOMINAL)

| | | |
|-----------------------------|------------------------------|------------------------------|
| Catalog number | HWAT-P1 | HWAT-R2 |
| Jacket color | Plum | Red |
| Maintain temperature range* | 105°F (40°C) to 130°F (54°C) | 105°F (40°C) to 140°F (60°C) |
| Weight | 230 lbs/1000 ft (0.35 kg/m) | |
| Dimensions | | |
| Width | 0.72 in (18 mm) | |
| Thickness | 0.38 in (10 mm) | |

* When designed in accordance with the HWAT System Product Selection and Design Guide

SCALD PROTECTION

HWAT systems present an increased risk of scalding due to the high water temperature. Pay special attention to the scald warning below:

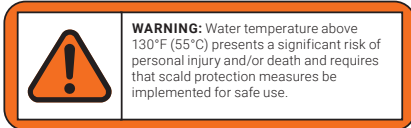

DESIGN AND INSTALLATION

For proper design and installation, use the Design section of the HWAT System Product Selection and Design Guide (H57538) and the HWAT System Installation and Operations Manual (H57548).

MAXIMUM CIRCUIT LENGTH FT (M)

| Breaker Size | HWAT-P1 @120 V | HWAT-R2 @208-277 V |
|--------------|----------------|--------------------|
| 10 Amp | 125 (38) | |
| 15 Amp | 195 (59) | 250 (75) |
| 20 Amp | 276 (84) | 330 (110) |
| 30 Amp | 395 (120) | 500 (150) |

GROUND FAULT PROTECTION

To minimize the danger of fire from sustained electrical arcing if the heating cable is damaged or improperly installed, and to comply with nVent requirements, agency certifications, and national electrical codes, 30-mA ground fault equipment protection must be used on each heating cable branch circuit. Arcing may not be stopped by conventional circuit protection.

APPROVALS



HWAT heating cables are c-UL-us Listed, CSA Certified, and FM Approved when used with the appropriate agency-approved nVent RAYCHEM components and accessories

North America

Tel +1.800.545.6258
 Fax +1.800.527.5703
 thermal.info@nVent.com



Our powerful portfolio of brands:

CADDY ERICO HOFFMAN RAYCHEM SCHROFF TRACER

Electronic Controller for Hot Water Temperature Maintenance Systems

PRODUCT OVERVIEW

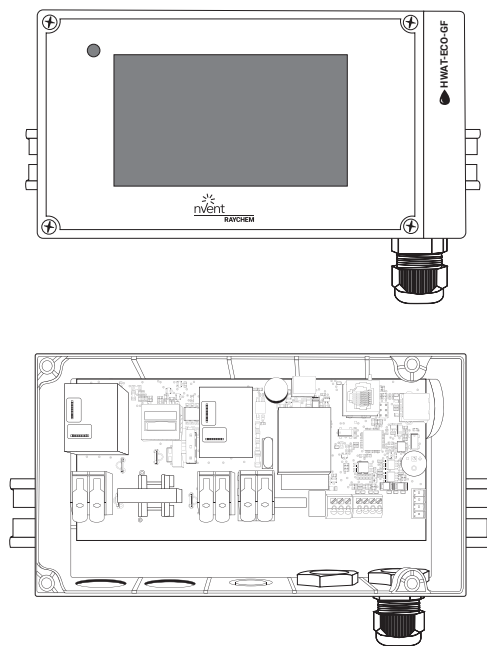

The nVent RAYCHEM HWAT-ECO-GF controller is designed for operation with the nVent RAYCHEM HWAT-R2 and HWAT-P1 self-regulating heating cables.

Features

- Equipment rated ground fault protection built-in
- Intuitive set-up and programming, includes a 5" inch color touch screen
- Flexible temperature control of hot water temperature maintenance systems
- Energy savings through an integrated function that lowers the maintain temperature during hours of low water consumption
- Heat-up cycle function that increases the water temperature of the hot water in the pipes
- Alarm relay to signal power, temperature or communication problems
- Hot water storage & pipe temperature monitoring with high and low temperature alarms and automatic system shut down
- Seven pre-defined building timer programs that can be customized by the user
- Program in advance in power-off mode by using external power bank/charger and USB connection

GENERAL

Area of use: Non-hazardous locations; for HWAT-R2 and HWAT-P1 heating cables only

APPROVALS

c-UL-us, ROHS, WEEE
Electromagnetic Compatibility (EMC)

UL LISTED TYPE 12
Energy Management Equipment
(for use with HWAT-R2 and HWAT-P1 only)

ELECTRICAL PROPERTIES

| | |
|---|---|
| Supply Voltage | HWAT-R2: 208/240/277 VAC, 60 Hz HWAT-P1: 120 VAC, 60 Hz |
| Controller ambient exposure temperature | 32°F (0°C) to 104°F (40°C) |
| Ambient operating range | 50°F (10°C) to 77°F (25°C) |
| Output relay switching capacity | 24A @ 120/208/240/277 VAC 60Hz |
| Alarm relay | Single pole double throw relay, volt-free, rating 1A/24 VAC or 24 VDC |
| Circuit breaker | 30 A Max. |

| | |
|-----------------|---|
| Ground fault | 30 mA, complies with UL 1053 standard |
| Real time clock | Automatic daylight saving time and leap year correction |
| Clock accuracy | +/-10 minutes per year |
| Keylock | Password protection for parameter settings |
| USB Port | For pre-setup in power off mode; for firmware upgrades |

ENCLOSURE

| | |
|--------------------------|---|
| Dimensions | 210 mm x 110 mm x 85 mm / 8.26" x 4.33" x 3.34" |
| Ingress protection class | TYPE 12 – indoor use only |
| Enclosure material | Polycarbonate |
| Mounting option | Mountable DIN RAIL, 35 mm |
| Conduit entries | Two each-1 in conduit entries |
| Cable gland | 3-hole grommet for temperature sensors maximum cable size -2 wire: 20 AWG (0,5 mm ²) |
| Storage temperature | -4°F (-20°C) to 105°F (40°C) |
| Flammability class | DIN EN 60730/VDE 0631-1 |

TYPICAL ENCLOSURE DIMENSIONS AND MODULE LAYOUT

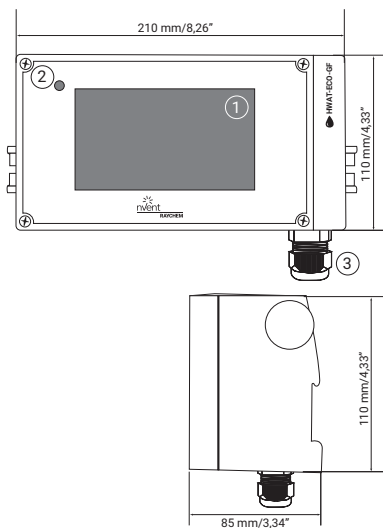

1. Touch Screen Size: 5" resistive
2. LED Blinking Power to heating cable
(60 flashes/min):
LED Blinking Fast Error/warning message
(90 flashes/min):
3. M20 Gland: Sensor hot water storage/sensor pipe/external alarm

PROGRAMMING

| | |
|--------------------------------|--|
| Maintain temperatures setpoint | 99°F (37°C) to 149°F (65°C) in 24 blocks of 1 hour per day |
| Default programs | 7 built-in building specific programs, editable |
| Timer | Program can be modified in steps of one hour; following operation modes are selectable: OFF, ECONOMY, MAINTAIN and HEAT-UP CYCLE |

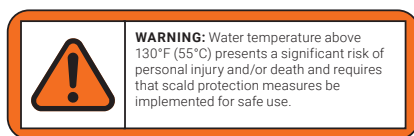

SENSOR

| | |
|--------------------------|--|
| Temperature sensor type | Thermistor 2 KOhm / 77°F (25°C), 2-wire |
| Sensor tip dimensions | Ø 0.2" (5 mm); length 0.8"(20 mm) |
| Sensor cable length | 10ft (3 m) cable extension up to 328 ft (100 m) / 2 x 16 AWG |
| Sensor temperature range | 32°F (0°C) to 194°F (90°C) |

MONITORING

| | |
|--------------------------|---|
| Boiler temperature alarm | High temperature alarm/cut-out Adjustable range: maintain temperature to 150°F/66°C or OFF |
| | Low temperature alarm Adjustable range: maintain temperature to 100°F/37°C or OFF |
| Pipe temperature alarm | High temperature alarm/cut-out Adjustable range: maintain temperature to 150°F/66°C or OFF |
| | Low temperature alarm Adjustable range: maintain temperature to 100°F/37°C or OFF |
| Sensor alarm | Sensor open circuit Sensor short circuit |
| Heating cable connection | Heating cable open circuit |

MEMORY

| | |
|--------------------|---|
| Parameters | All parameters are stored in nonvolatile memory, except date and time |
| Clock back-up time | 10 days |

ELECTRICAL SCHEME

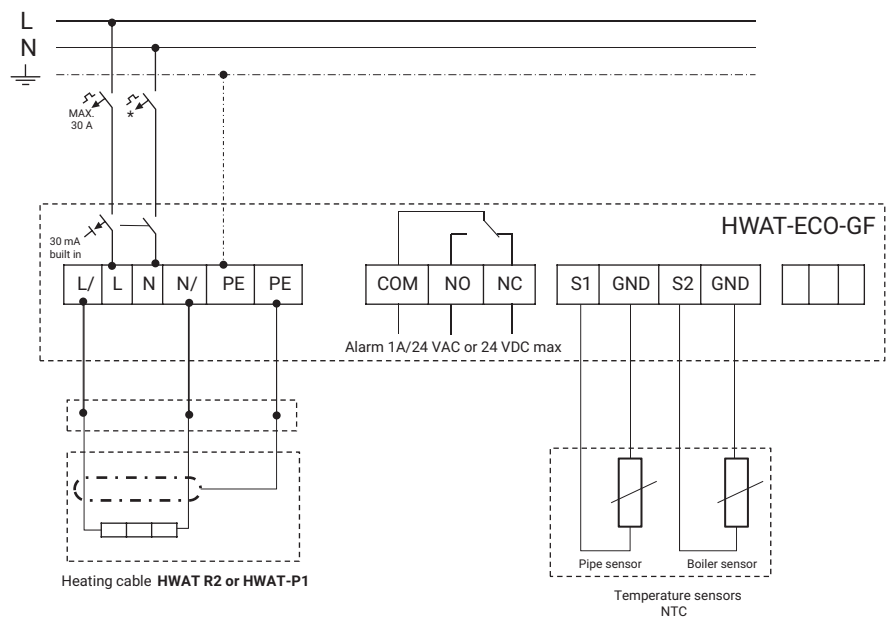

| | |
|-------------------------------|-------------------------------------|
| Size power supply terminals | 3 x 6 mm ² max./10 AWG |
| Size heating cable terminals | 3 x 6 mm ² max./10 AWG |
| Size alarm terminals | 3 x 1,5 mm ² max./16 AWG |
| Size sensor terminal - boiler | 2 x 1,5 mm ² max./16 AWG |
| Size sensor terminal - pipe | 2 x 1,5 mm ² max./16 AWG |

ORDERING DETAILS

| Description | Catalog | Part Number | Weight |
|---|-----------------|-------------|--------------|
| Controller with 10ft/3m sensor and din-rail | HWAT-ECO-GF | P000002274 | 2.3lbs/1050g |
| Spare Parts and Accessories | | | |
| Replacement Pipe Sensor | HWAT-ECO-Sensor | 1244-015847 | 0.33lbs/150g |
| Power Bank | R-PB-Powersmart | 1244-020365 | 0.33lbs/150g |

Important: The HWAT-ECO-GF controller is for use with the HWAT-R2 and HWAT-P1 heating cables only. The warranty and system listing will be invalidated if the HWAT-ECO-GF controller is used with other heating cables.

CONNECTION KITS AND ACCESSORIES FOR XL-TRACE, ICESTOP AND HWAT SELF-REGULATING HEATING CABLES

PRODUCT OVERVIEW

The nVent RAYCHEM RayClic connection system is a simple, fast and reliable set of connection kits developed for select XL-Trace, IceStop and HWAT self-regulating heating cables. There is no wire stripping needed because the insulation displacement connector makes the electrical connection.

The easy-to-install RayClic connection system reduces installation time, lowering the total installed cost of the heating cable system.

Simple

- No need for special tools
- Three-step installation

Reliable

- Intuitive installation
- Rugged, waterproof, UV-resistant enclosure

Cost-effective

- Quick installation

POWERED CONNECTION KITS

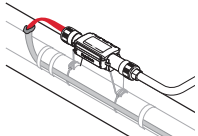
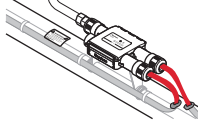
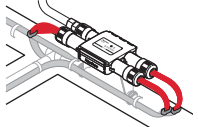
| Catalog number | Part number | Description |
|---|-------------|--|
|  RayClic-PC | 233053-000 | <p>A RayClic-PC can supply power to one heating cable. Each kit contains one RayClic-PC power connection, one RayClic-E end seal, and one SB-04 pipe mounting bracket. The kit includes 5' power lead wires and a conduit fitting; the junction box and flexible conduit required to make a complete connection are not included.</p> <p>Weight: 1.8 lb (0.8 kg)</p> |
|  RayClic-PS | 861247-000 | <p>A RayClic-PS can be used as a power connection kit for supplying power to two heating cables. Each kit contains one RayClic-PS powered splice connection, two RayClic-E end seals, and one SB-04 pipe mounting bracket. The kit includes 5' power lead wires and a conduit fitting. The junction box and flexible conduit required to make a complete connection are not included.</p> <p>Weight: 2.0 lb (0.9 kg)</p> |
|  RayClic-PT | 804231-000 | <p>A RayClic-PT can be used as a power connection kit for supplying power to three heating cables. Each kit contains one RayClic-PT powered tee connection, three RayClic-E end seals, and one SB-04 pipe mounting bracket. The kit includes 5' power lead wires and a conduit fitting. The junction box and flexible conduit required to make a complete connection are not included.</p> <p>Weight: 2.0 lb (0.9 kg)</p> |

UNPOWERED CONNECTION KITS

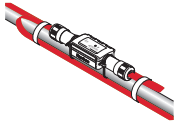
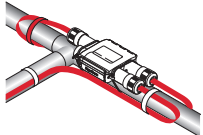
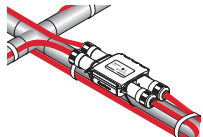
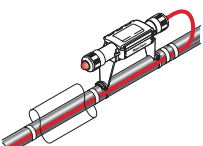
| Catalog number | Part number | Description |
|---|-------------|--|
| RayClic-S | 559871-000 | Splice kits are installed as needed to connect two heating cables together at one point. Each kit contains one RayClic-S splice. Weight: 1.3 lb (0.6 kg) |
|  | | |
| RayClic-T | 014023-000 | Tee kits are installed as needed to connect three heating cables together at one point. Each kit contains one RayClic-T tee connection and one RayClic-E end seal. Weight: 1.9 lb (0.9 kg) |
|  | | |
| RayClic-X | 546349-000 | RayClic-X kits are installed as needed to connect four heating cables together at one point. Each kit contains one RayClic-X cross and two RayClic-E end seals. Weight: 2.0 lb (0.9 kg) |
|  | | |
| RayClic-LE | P000000770 | Lighted end seal kits are installed wherever an end-of-line signal light is required. Each kit contains one RayClic-LE lighted end seal and one RayClic-SB-04 pipe mounting bracket. Weight: 1.8 lb (0.8 kg) |
|  | | |

ACCESSORIES

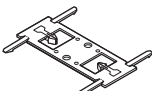
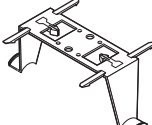
| Catalog number | Part number | Description |
|---|-------------|---|
| RayClic-E | 805979-000 | The RayClic-E is a replacement end seal kit. |
|  | | |
| RayClic-SB-02 | 852001-000 | The RayClic-SB-02 is a wall mounting bracket for use with any RayClic connection kit. |
|  | | |
| RayClic-SB-04 | 616809-000 | The RayClic-SB-04 is a pipe mounting bracket for use with any RayClic connection kit. One pipe mounting bracket is included with each powered connection kit and the RayClic-LE lighted end seal kit. |
|  | | |

RAYCLIC SYSTEM SPECIFICATIONS

| | |
|----------------------------------|--------------|
| Rated voltage | 120–277 V |
| Maximum circuit breaker size | 30 A |
| Maximum exposure temperature | 150°F (65°C) |
| Minimum installation temperature | 0°F (–18°C) |
| Enclosure rating | NEMA 4X |

APPLICABLE PRODUCTS

| | |
|----------|----------------------------------|
| XL-Trace | 5/8XL1-CR/CT and 5/8/12XL2-CR/CT |
| IceStop | GM-1XT, GM-1X, GM-2XT and GM-2X |
| HWAT | HWAT-R2, HWAT-P1 |

APPROVALS



718K Pipe Heating Cable
877Z De-Icing and Snow Melting



With XL-Trace and IceStop
heating cable only
For Class I, Div. 2,
Groups A,B,C,D
hazardous locations- GM-1XT
and GM-2XT only

DESIGN AND INSTALLATION

For proper design and installation of a RayClic connection system, use the appropriate product design guide and the installation instructions included with the connection kit.

GROUND-FAULT PROTECTION

To minimize the danger of fire from sustained electrical arcing if the heating cable is damaged or improperly installed, and to comply with the requirements of nVent, agency certifications, and national electrical codes, ground-fault equipment protection must be used on each heating cable branch circuit. Arcing may not be stopped by conventional circuit protection. Many RAYCHEM control and monitoring systems meet the ground-fault protection requirement.

North America

Tel +1.800.545.6258

Fax +1.800.527.5703

thermal.info@nvent.com



nVent.com

Our powerful portfolio of brands:

CADDY ERICO HOFFMAN RAYCHEM SCHROFF TRACER

ATTACHMENT PRODUCTS

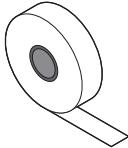
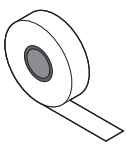
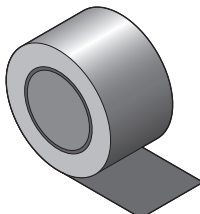
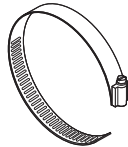
| Catalog number | Part number | Description |
|---|--|---|
| GT-66  | C77220-000 | 66 ft (20 m) roll of glass tape for attaching heating cable to pipe. Not for stainless steel pipes or for installation temperatures below 40°F (5°C). |
| GS-54  | C77221-000 | 54 ft (16.5 m) roll of glass tape for attaching heating cable to pipe. For stainless steel pipes or for any installation below 40°F (5°C). |
| AT-180  | 158139-000 | 180 ft (55 m) roll of aluminum tape for attaching heating cables and thermostat sensors to pipes and tanks. Minimum installation temperature: 32°F (0°C). Dimensions: 2.5 in wide, 5 mils thick. |
| Pipe straps  | PS-01 C77211-000 PS-03 C77212-000 PS-10 C77213-000 PS-20 C77216-000 | For conduit ≤ 1 in For connection kits on pipes with dimensions ≤ 2 in For connection kits on pipes with dimensions 2 in – 10 in For connection kits on pipes with dimensions 10 in – 19.5 in Used to secure connection kits and brackets to pipes. Order by pipe diameter, as shown above. |

LABELS

| Catalog number | Part number | Description |
|----------------|-------------|---|
| ETL | C77203-000 | “Electric Traced” label for identifying traced pipes and tanks. |

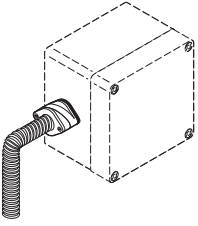

GLAND ENTRY KIT

| Catalog number | Part number | Description | Kit Contents | |
|---|-------------|--|--------------|-----------------------------|
| | | | Qty | Description |
| C75-100-A  | 000539-000 | A NEMA 4X-rated gland kit used to transition heating cables into a junction box when making connections off of a pipe or tank. It may be used for power, splice, or tee connections. For use with nVent RAYCHEM brand BTV, QTVR, XTV, KTV ⁽¹⁾ , VPL, and LBTV2-CT ⁽²⁾ heating cables. The kit does not include the junction box, flexible tubing, or tape that are required to make a complete connection. (1) For KTV only, order PMK-GP-10 grommet (P/N 700823) (2) For LBTV2-CT only, order HCS-100-A heat-shrink core sealer (P/N 257649) and PMK-GK-10 grommet (P/N 222724) | 1 | Red grommet |
| | | | 1 | Gland with threaded inserts |
| | | | 1 | Gland with screws |
| | | | 1 | Gland gasket |
| | | | 1 | Locknut |
| | | | 1 | Green / yellow tube |
| | | | 1 | CS-100 core sealer |
| | | | 1 | Terminal block |

SINGLE-ENTRY TRANSITION KIT

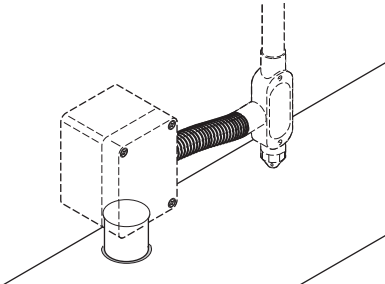
| Catalog number | Part number | Description | Kit Contents | |
|---|-------------|---|--------------|---------------------------------|
| | | | Qty | Description |
| JS-100-A  | 166639-000 | Junction box stand for use with nVent RAYCHEM brand BTV, QTVR, XTV, KTV, and VPL heating cables. A separate customer-supplied NEMA 4X junction box is required. | 1 | Stand assembly |
| | | | 1 | Lubricant |
| | | | 1 | Adapter for small pipes |
| | | | 1 | Cable tie |
| | | | 1 | Green / yellow tube |
| | | | 1 | CS-100 cold-applied core sealer |
| | | | 1 | JS-100 transition |
| | | | 1 | 1-inch locknut |

COLD-APPLIED CORE SEALER

| Catalog number | Part number | Description |
|-----------------|-------------|--|
| CS-100-A | 232949-000 | Replacement cold-applied core sealer for nVent RAYCHEM brand BTV, QTVR, XTV, KTV, and VPL heating cables |

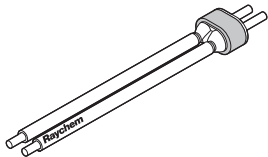

CONDUIT DRAIN

| Catalog number | Part number | Description |
|----------------------------|-------------|---|
| JB-DRAIN-PLUG-3/4IN | 278621-000 | nVent recommends the use of this 3/4-in conduit drain with each JBS-100 and JBM-100, and other enclosures with associated conduits, to prevent condensate from collecting in the box. |

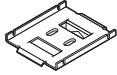
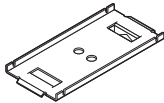
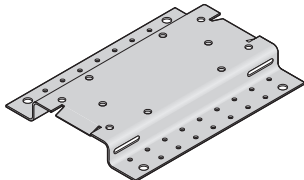
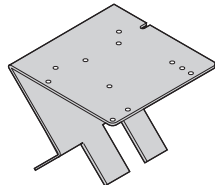
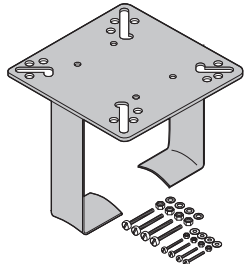

BRACKETS, ADAPTERS

| Catalog number | Part number | Description |
|--|-------------|--|
| JBS-SPA  | E90515-000 | Adapter for mounting E-100, JBS-100, and JS-100 to small pipe (≤ 1 inch nominal diameter). |
| JBM-SPA  | D55673-000 | Adapter for mounting JBM-100 and T-100 to small pipe (≤ 1 inch nominal diameter). |
| SB-100-T  | 279613-000 | Adapter for mounting E-100, E-100-L, and JBS-100 connection kits on a tank surface. |
| UMB  | 263757-000 | Universal mounting bracket for mounting thermostats and other equipment on a pipe. |
| JB-SB-25  | 471139-000 | Stainless-steel mounting bracket for RAYSTAT-EX-03-A thermostat. |

HELICAL FLEXIBLE PLASTIC TUBING

| Catalog number | Part number | Description |
|---|-------------|--|
| HCTE-1000  | 3679754004 | Helical flexible plastic tubing for C75-100-A and HAK-C-100 connection kits. |



RAYCHEM

HWAT System

Installation and Operation Manual for
Hot Water Temperature Maintenance
Systems for Thermally Insulated Pipes

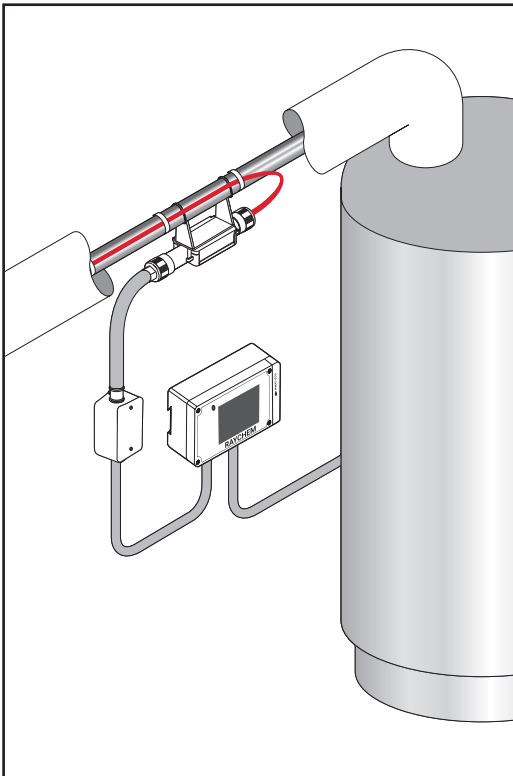

Important Safeguards and Warnings

WARNING: FIRE AND SHOCK HAZARD

nVent RAYCHEM HWAT systems must be installed correctly to ensure proper operation and to prevent shock and fire. Read these important warnings and carefully follow all the installation instructions.

- To minimize the danger of fire from sustained electrical arcing if the heating cable is damaged or improperly installed, and to comply with nVent requirements, agency certifications, and national electrical codes, ground-fault equipment protection must be used on each heating cable branch circuit. Arcing may not be stopped by conventional circuit breakers.
- Approvals and performance are based on the use of nVent parts only. Do not substitute parts or use vinyl electrical tape.
- Bus wires will short if they contact each other. Keep bus wires separated.
- Connection kits and heating cable ends must be kept dry before and during installation.
- The black heating cable core is conductive and can short. They must be properly insulated and kept dry.
- Damaged bus wires can overheat or short. Do not break bus wire strands when preparing the cable for connection.
- Damaged heating cable can cause electrical arcing or fire. Do not use metal attachments such as pipe straps or tie wire. Use only nVent approved tapes and cable ties to secure the cable to the pipe.
- Do not attempt to repair or energize damaged cable. Remove damaged cable at once and replace with a new length using the nVent RAYCHEM RayClic-S splice kit. Replace damaged connection kits.
- Use only fire-resistant insulation which is compatible with the application and the maximum exposure temperature of the system to be traced.



WARNING: Water temperature above 130°F (55°C) presents a significant risk of personal injury and/or death and requires that scald protection measures be implemented for safe use.

Table of Contents

| | | |
|----------|---|-----------|
| 1 | General Information | 1 |
| | 1.1 Use of the Manual | 1 |
| | 1.2 Safety Guidelines | 2 |
| | 1.3 Typical HWAT System | 2 |
| | 1.4 Electrical Codes | 3 |
| | 1.5 Approvals | 3 |
| | 1.6 Warranty | 4 |
| | 1.7 Trade Coordination | 4 |
| | 1.8 General Installation Notes | 5 |
| | 1.9 Tools Required | 6 |
| 2 | Heating Cable Verification and Selection | 7 |
| | 2.1 Heating Cable | 7 |
| 3 | Heating Cable Installation | 8 |
| | 3.1 Heating Cable Storage | 8 |
| | 3.2 Pre-Installation Checks | 8 |
| | 3.3 Installation | 8 |
| 4 | Heating Cable Components | 14 |
| | 4.1 General Connection Kit Information | 14 |
| 5 | Control and Monitoring | 16 |
| | 5.1 HWAT-ECO-GF and ACS-30 Controllers | 16 |
| 6 | Thermal Insulation | 17 |
| | 6.1 Insulating the System | 17 |
| | 6.2 Insulation Installation | 17 |
| 7 | Power Supply and Electrical Protection | 20 |
| | 7.1 Voltage Rating | 20 |
| | 7.2 Circuit Breaker Sizing | 20 |
| | 7.3 Electrical Loading | 20 |
| | 7.4 Ground-Fault Protection | 21 |
| 8 | Commissioning and Preventive Maintenance | 22 |
| | 8.1 Tests | 22 |
| | 8.2 Preventative Maintenance | 24 |

| | | |
|----------|-------------------------------------|-----------|
| 9 | Test Procedures | 25 |
| | 9.1 System Tests | 25 |
| | 9.2 Fault Location Tests | 31 |
| | 9.3 Cable and Connection Continuity | |

| | | |
|-----------|------------------------|-----------|
| 10 | Test Procedures | 34 |
|-----------|------------------------|-----------|

| | | |
|-----------|------------------------------|-----------|
| 11 | Troubleshooting Guide | 38 |
|-----------|------------------------------|-----------|

1

General Information

1.1 Use of the Manual

This installation and operation manual is for nVent RAYCHEM HWAT Hot Water Temperature Maintenance systems installed on thermally insulated pipes only.

This manual details how to install and operate an HWAT system. The HWAT system includes the nVent RAYCHEM HWAT-R2 heating cable, RayClic connection kits, and the nVent RAYCHEM HWAT-ECO-GF or ACS-30 controllers. It is important to review this manual and the following documents with the installing contractor:

- HWAT System Catalog (H57538)
- HWAT System Design Guide (H57510)
- HWAT-ECO-GF Data Sheet (H60160)
- ACS-30 Multipoint Commercial heat-tracing Control System Data Sheet (H58261)
- HWAT Heating Cable Data Sheet (H57512)
- RayClic Connection System Data Sheet (H57545)
- HWAT-ECO-GF Installation and Operation Manual (H60223)
- ACS-30 Programming Guide (H58692)

For additional information, contact:

nVent

7433 Harwin Drive
Houston, TX 77036
USA

Tel: +1.800.545.6258

Fax: +1.800.527.5703

thermal.info@nvent.com

nVentthermal.com



Important: For the nVent warranty and agency approvals to apply, the instructions that are included in this manual and product packages must be followed.



1

General Information

1.2 Safety Guidelines

The safety and reliability of any heat-tracing system depends on the quality of the products selected, and on proper design, installation, and maintenance. Incorrect design, handling, installation, or maintenance of any of the system components can cause underheating or overheating of the pipe, or damage to the heating cable system, and may result in system failure, electric shock, or fire. The guidelines and instructions contained in this guide are important. Follow them carefully to minimize these risks and to ensure that the HWAT system performs reliably.

Pay special attention to the following:

- Instructions marked  Important
- Warnings marked  WARNING

1.3 Typical HWAT System

A typical HWAT system is shown in Figure 1. The heating cable is cut to length in the field and is attached to the pipe with glass tape. A power connection kit connects the heating cable bus wires to power in a junction box. RayClic tees and splices accommodate pipe branches to connect two or three heating cables together. An end seal kit is used to terminate the end of the heating cable. A controller is used to set the maintain temperature and improve energy savings.

1

General Information

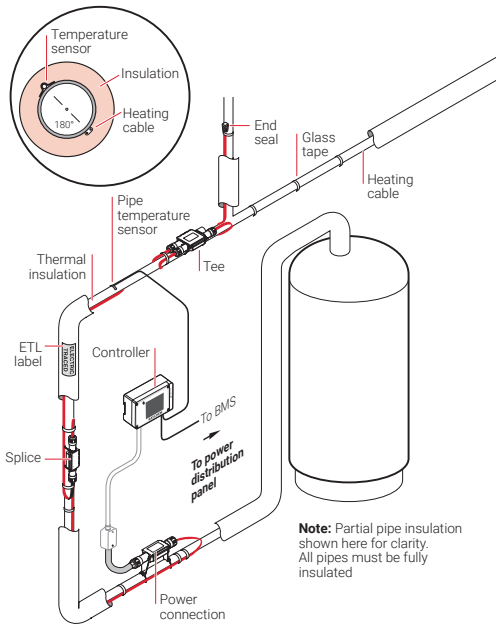

Figure 1: Typical HWAT heating cable system

1.4 Electrical Codes

Section 427 of the National Electrical Code (NEC), and Part 1, Section 62 of the Canadian Electrical Code (CEC), in particular, govern the installation of electrical heat-tracing systems used on hot water pipes. All installations must be in compliance with this and any other applicable national or local codes.

1.5 Approvals

HWAT-R2 heating cable and RayClic connection kits are UL Listed, CSA certified and FM Approved for use in non-hazardous locations. The HWAT-ECO-GF controller is c-UL-us Listed and the ACS-30 controller is c-CSA-us certified (ACS-UIT) to US and Canadian standards for use in non-hazardous locations. Refer to the specific product data sheets for details.

1

General Information

1.6 Warranty

nVent standard limited warranty applies to all products.



An extension of the limited warranty period to ten (10) years from the date of installation is available if a properly completed on-line warranty form is completed within (30) days from the date of installation. The extension is valid for the HWAT-R2 heating cable, RayClic connection kits and accessories, but **not** the HWAT-ECO-GF or ACS-30 controllers. You can access the complete warranty on nVentthermal.com/support/warranty.

1.7 Trade Coordination

Installation of an HWAT system can involve or impact the work of numerous trades. Therefore, effective and early coordination between trades is a critical aspect of all HWAT system installations. The installation of the heating cable and connections must be properly scheduled, along with the scheduling of the risers and insulation installation.

This guide will assist the installer throughout the installation process and must be reviewed by all affected trades before installation of the HWAT system begins. In a fast-track job, the HWAT system must be considered a critical path item: the pipe, heating cable, insulation, and wallboard must all be installed in the proper order, since the heating cable cannot be installed later. If, for example, the walls go up before the heating cable commissioning tests have been completed, it may be necessary to remove the walls in order to repair a damaged or improperly installed system.

Ensuring that the installation of the HWAT system is included in the overall construction schedule will help ensure a successful and trouble-free installation.

1

General Information

1.8 General Installation Notes

Read and observe the instructions in this guide to insure that the HWAT system is installed successfully.

- Accidental damage to the system can be minimized during construction by installing thermal insulation on the pipe immediately after the pipe has been traced and the heating cable has been tested.
- Read all installation documentation to familiarize yourself with the system components.
- Read and follow all warnings and recommendations. All involved trades should review this entire guide and assess the recommendations applicable to their scope of work.
- All heat-traced pipes and equipment must be thermally insulated. Insulation is an essential part of the HWAT system. For an effective system, the fiberglass insulation must be a specific thickness for each specific pipe size as detailed in Table 2 on page 17.
- Do not install the HWAT system below the minimum installation temperature.
 - The minimum installation temperature for HWAT heating cables is 0°F (–18°C)
 - The minimum installation temperature for HWAT-ECO-GF is 40°F (5°C).
- Ensure that your water heater temperature is set at your desired pipe maintain temperature.
- Do not energize cable when it is coiled or on the reel.
- Never use metal tie wire or pipe straps to secure heating cables to pipes.



Important: Exceeding 185°F (85°C) for HWAT-R2 will decrease the power output of the heating cables over time.

1

General Information

1.9 Tools Required

For installing cable and connection kits:

- Utility knife
- Diagonal cutters
- Cable cutters
- Tape measure
- Screwdriver
- Heat gun or propane torch

For testing the heating cable:

- Megohmmeter 2500 Vdc
- Multimeter (voltage, resistance and capacitance)

2

Heating Cable Verification and Selection

2.1 Heating Cable

The HWAT system includes HWAT-R2 heating cable designed to maintain the piping at specific temperature settings with the use of the HWAT-ECO-GF or ACS-30 controllers. Figure 2 shows the construction of the heating cable.

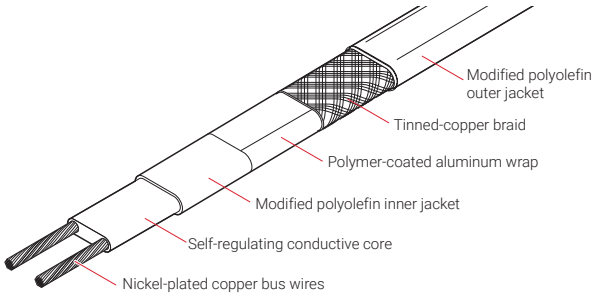

Figure 2: HWAT-R2 heating cable

The minimum control setpoint for HWAT-R2 is 105°F (40°C). The maximum control setpoint for HWAT-R2 is 140°F (60°C).

3

Heating Cable Installation

3.1 Heating Cable Storage

- Store the heating cable in a clean, dry location. Temperature range: 0°F (-18°C) to 140°F (60°C).
- Protect the heating cable from mechanical damage.

3.2 Pre-Installation Checks

Check materials received:

- Review the heating cable design and compare the list of materials to the catalog numbers of the heating cables and connection kits received to confirm that the proper materials are on site. The heating cable type is printed on its jacket.
- The HWAT system is limited to 208–277 V service when using the HWAT-ECO-GF controller. When using the ACS-30 controller the voltage range is also 208–277 V. Ensure that the service voltage available is correct.
- Inspect the heating cable and connection kits to ensure there is no in-transit damage.
- Verify that the heating cable jackets are not damaged by conducting the insulation resistance test (refer to Section 9) on each reel of cable. Do not power the heating cable when it's on the reel.

Check piping to be traced:

- Make sure all mechanical pipe testing (i.e. hydrostatic testing/purging) is complete and the system has been cleared by the client for tracing.
- Walk the system and plan the routing of the heating cable on the pipe.
- Inspect the piping and remove any burrs, rough surfaces or sharp edges.

3.3 Installation

- Pay out the heating cable, loosely stringing it along the pipe, making sure that the cable is always next to the pipe when crossing obstacles.

3

Heating Cable Installation

- Install HWAT heating cable in straight runs along the pipe. **Spiraling the heating cable is not necessary.**
- If the cable is on the wrong side of an obstacle such as a crossing pipe or I-beam, you will need to reinstall it or cut and splice it.
- When installing the heating cable, the cable **must not** be compressed or pinched between two objects. Wall and floor penetrations and pipe hangers are particular areas of concern.

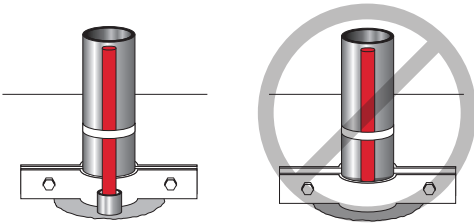

Figure 3: Protecting the heating cable in floor penetrations

- Run insulation through the pipe hanger ensuring that the pipe is not resting on the heater.

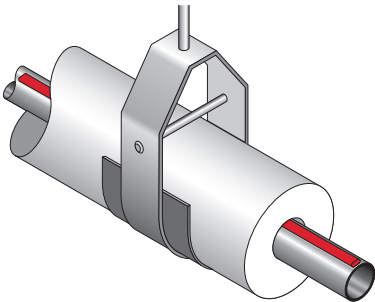

Figure 4: Pipe hanger with heating cable

- When making floor or wall penetrations, make sure the hole is large enough to accommodate the pipe and the thermal insulation. When sealing around pipes at floor penetrations, avoid damaging or cutting the heating cable, or pinching it between the pipe and the concrete.

3

Heating Cable Installation

- The heating cable must not be embedded directly in the sealing material; the pipe should have thermal insulation over it (if allowed by local codes) or the heating cable should be run through the penetration in a tube or conduit. If the conduit must be sealed, use a pliable fire-resistant material (STI Firestop, Dow Corning Fire Stop, 3M Fire Barrier, or T&B Flame-Safe) that can be removed if necessary.

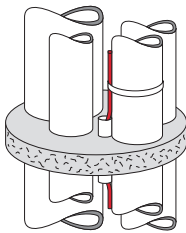

Figure 5: Multiple pipe floor penetration

- On vertical piping groups, run the heating cable along the inside of the pipe close to other pipes so it will not be damaged if the pipe hits the side of the floor penetration. Run the heating cable over the outside of the pipe support. Do not clamp the heating cable to the pipe with the pipe support.
- In high-rise construction it may be necessary to install the HWAT system 10 or 12 floors at a time to fit into the construction schedule. If so, the end of the heating cable should be sealed with a RayClic-E end seal and placed in an accessible location. This allows testing of one part of the heating cable at a time, and allows splicing it to another section when the system is complete.

Paying out the cable:

- Use a reel holder that pays out smoothly with little tension. If the heating cable snags, stop pulling.
- Keep the heating cable strung loosely but close to the pipe being traced to avoid interference with supports and equipment.
- Meter marks on the heating cable can be used to determine cable length.

3

Heating Cable Installation

- Protect all heating cable ends from moisture, contamination and mechanical damage.

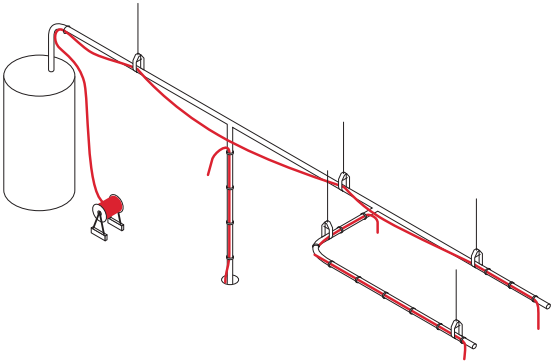

Figure 6: HWAT cable layout

When paying out the heating cable, AVOID:

- Sharp edges
- Excessive pulling force or jerking
- Kinking and crushing
- Walking on it, or running over it with equipment

⚠ WARNING: Fire and shock hazard. Do not install damaged cable. Connection kits and cable ends must be kept dry before and during installation.

Positioning heating cables

If possible, position the heating cable on the lower section of the pipe, at the 4 or 8 o'clock positions, as shown below, to protect it from damage.

3

Heating Cable Installation

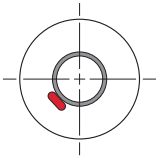

Figure 7: Cable positioning

Attaching the heating cable

Starting from the end opposite the reel, tape the heating cable to the pipe every 2 feet. Work back to the reel. Leave extra heating cable at the power connection, at all sides of splices and tees to allow for future servicing. See Table 1 on page 15.

- Install heating cable connection kits immediately after attaching the heating cable. If immediate installation is not possible, protect the heating cable ends from moisture.

Bending the cable

When positioning the heating cable on the pipe, do not bend tighter than 1/2" radius. The heating cable does not bend easily in the flat plane. Do not force such a bend, as the heating cable will be damaged.

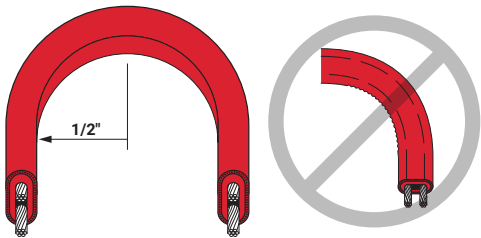

Figure 8: Bending technique

Crossing the cable

HWAT heating cables are self-regulating and may be overlapped whenever necessary without overheating or burning out.

Cutting the cable

Cut the heating cable to the desired length after it is attached to the pipe. HWAT can be cut to length without affecting the heat output per foot.

3

Heating Cable Installation

Attachment tapes

To ensure that the heating cable is in full contact with the pipe, use tape to attach the heating cable to the pipe every 2 ft (.6 m). Use nVent RAYCHEM GT-66 attachment tape. One roll will handle approximately 50 ft (15 m) of cable.

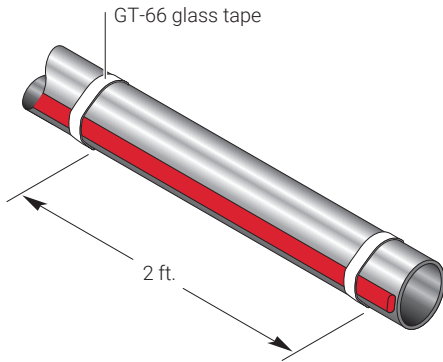

Figure 9: Attaching the heating cable

To ensure sufficient heat transfer nVent RAYCHEM AT-180 aluminum tape must be used to install the heating cable on plastic pipes as shown in Figure 10.

⚠ WARNING: Do not use metal attachments such as pipe straps or tie wire. Do not use vinyl-based electrical or duct tape. Use only nVent approved tapes.

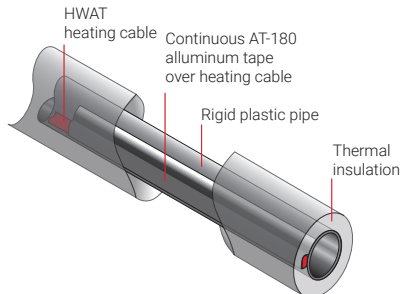

Figure 10: Installed on plastic pipe with aluminum tape

4

Heating Cable Components

4.1 General Connection Kit Information

RayClic connection kits must be used with HWAT-R2 heating cable. A complete circuit requires a power connection and an end seal. Splices and tees and other connection kits are used as needed. Use the HWAT System Design Guide (H57510) to select appropriate connection kits. Installation instructions are included with every connection kit. Steps for preparing the heating cable and installing connection kits must be followed. HWAT connection kit locations should be noted on “As Built” drawings. Connection kit locations should be marked on the outside of the insulation cladding with the labels provided in the kits.

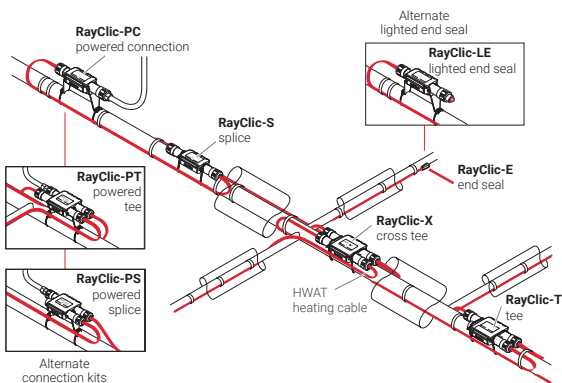

Figure 11: RayClic connection system

Connection Kit Installation

- When practical, mount the connection kits on top of the pipe. All heating cable connections must be mounted above grade level.
- Leave excess cable to serve as a service loop at all connection kits (power, splice, cross or tee) for future maintenance, as detailed in Table 1. The additional heating cable will easily pay for itself in time savings if it becomes necessary to check or replace a connection kit after installation. Splices and tees should have a service loop on each of the heating cables entering the connection kit.

4

Heating Cable Components

TABLE 1: SERVICE LOOPS FOR EACH CONNECTION KIT

| Connection kit name | # of cable connections/kit | Cable length/ connection | Total cable length (Service loop) |
|---------------------|----------------------------|--------------------------|-----------------------------------|
| RayClic-PC | 1 | 2.0 ft (0.6 m) | 2 ft (0.6 m) |
| RayClic-S | 2 | 1.0 ft (0.3 m) | 2 ft (0.6 m) |
| RayClic-T | 3 | 1.0 ft (0.3 m) | 3 ft (0.9 m) |
| RayClic-X | 4 | 1.0 ft (0.3 m) | 4 ft (1.2 m) |
| RayClic-PS | 2 | 1.5 ft (0.5 m) | 3 ft (0.9 m) |
| RayClic-PT | 3 | 1.3 ft (0.4 m) | 4 ft (1.2 m) |
| RayClic-E | 1 | NA | NA |
| RayClic-LE | 1 | 2.0 ft (0.6 m) | 2.0 ft (0.6m) |

- All power connection kits must be installed in accessible locations. Access to splices, tee kits and end seals is recommended for future modification or maintenance but is not required.
- Locate junction boxes for easy access but not where they may be exposed to mechanical abuse.
- Heating cables must be installed over, not under, pipe straps used to secure components.



WARNING: The black heating cable core is electrically conductive and can short. It must be properly insulated and kept dry. Damaged bus wires can overheat or short.



WARNING: Fire and shock hazard. nVent RAYCHEM brand specified components must be used. Do not substitute parts or use vinyl electrical tape.



WARNING: Water temperature above 130°F (55°C) presents a significant risk of personal injury and/or death and requires that scald protection measures be implemented for safe use.

5

Control and Monitoring

5.1 HWAT-ECO-GF and ACS-30 Controllers

The HWAT-ECO-GF controller is designed for use only with HWAT-R2 heating cable and must be used to ensure proper water temperature.

Refer to the HWAT-ECO-GF Installation and Operation Manual (H60223) for the installation and operation instructions of the controller.

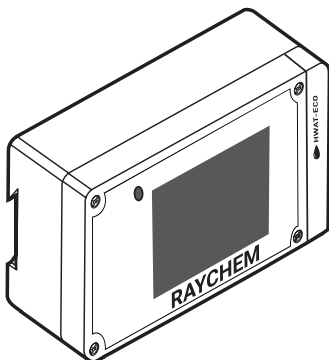

Figure 12: HWAT-ECO-GF controller

The ACS-30 Control System is also approved for use with HWAT-R2 heating cable. Refer to the ACS-30 Programming Guide (H58692) for the installation and operating instructions of the control system.

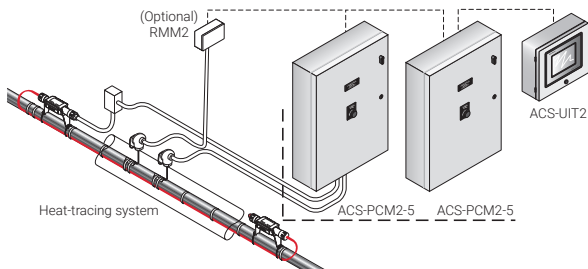

Figure 13: ACS-30 Control System

6

Thermal Insulation

6.1 Insulating the System

Pipes must be insulated with the correct thermal insulation to maintain the desired pipe temperatures. For pipes 1 1/4 inches and smaller, use insulation that is oversized by 1/4 inch to allow room for insulating over the heating cables. The thermal insulation schedule is shown in Table 2.

TABLE 2: FIBERGLASS INSULATION SCHEDULE

| Copper pipe size (in) | IPS insulation size (in) | Insulation thickness (in) |
|-----------------------|--------------------------|---------------------------|
| 1/2 | 3/4 | 1/2 |
| 3/4 | 1 | 1 |
| 1 | 1 1/4 | 1 |
| 1 1/4 | 1 1/2 | 1 1/2 |
| 1 1/2 | 1 1/2 | 1 1/2 |
| 2 | 2 | 2 |
| 2 1/2 | 2 1/2 | 2 1/2 |
| 3 | 3 | 3 |



Important: For pipes 3 inches and larger, the thickness of insulation can be equal to the pipe diameter with one run of heating cable or 1/3 the pipe diameter with two runs of heating cable.

6.2 Insulation Installation

- Before insulating the pipe, visually inspect the heating cable and connection kits to ensure they are properly installed and there are no signs of damage. Damaged cable or connection kits must be replaced.
- Check that the insulation type and thickness complies with the insulation schedule detailed in Table 2.
- Insulate the pipes immediately after the heating cable is installed and has passed all tests to minimize damage to the cable.
- Insulate the pipe at floor and wall penetrations. Failure to do so will cause cold spots in the water system and could lead to damage to the heating cable. If local codes do not allow this, the heating cable should be run through a conduit or channel before the firestop

6

Thermal Insulation

- is installed. Use a fire-resistant sealing compound such as STI Firestop, Dow Corning Fire Stop, 3M Fire Barrier, or T&B Flame-Safe.
- Do not use staples to close the insulation. Use tape or the adhesive-lined edge of the insulation to ensure that the seam remains sealed. Staples can damage the HWAT heating cable.

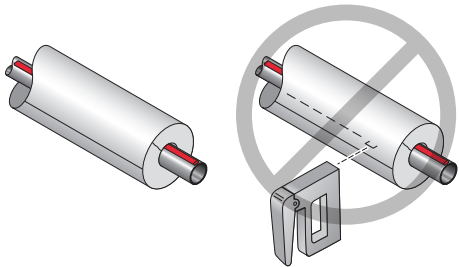

Figure 14: Sealing the insulation seam

- When installing splice, tee and end seal kits underneath the thermal insulation, mark the location of splices, tees, and end seals on the outside of the insulation, with labels provided in the kits, while installing the insulation. Use large diameter insulation or sheets to cover splices, tees, or service loops.

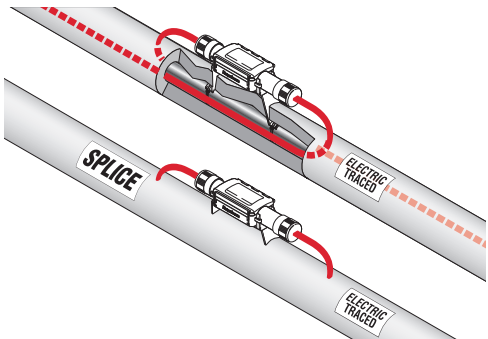

Figure 15: Installing Connection kits above insulation.

- All power connection kits must be mounted above the thermal insulation.

6

Thermal Insulation

- Splice and Tee connection kits may be installed above the insulation using the optional SB-04 mounting bracket. The pipe and heating cable service loops must be fully insulated as shown above.

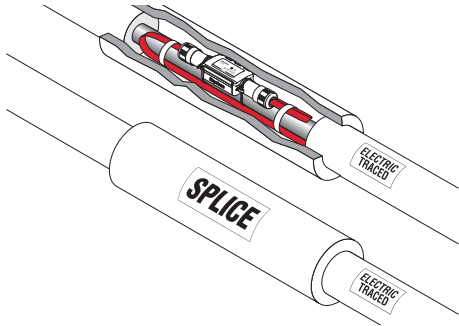

Figure 16: Installing connection kits below insulation.

- Make sure that all heat-traced piping, fittings, wall penetrations, and branch piping are insulated. Correct temperature maintenance requires properly installed and dry thermal insulation. Uninsulated sections of pipe can result in cold spots.
- After installing insulation, electrical codes require that you install “Electric Traced” labels along the piping at suitable intervals (10-foot intervals recommended) on alternate sides.



WARNING: Use only fire-resistant insulation, such as fiberglass.

7

Power Supply and Electrical Protection

7.1 Voltage Rating

Verify that the supply voltage is either 208–277 V as specified by the HWAT system design.

7.2 Circuit Breaker Sizing

Circuit breakers must be sized using the cable lengths shown in Table 3. Do not exceed the maximum circuit length shown for each breaker size. Ground-fault protection is integrated into the HWAT-ECO-GF and ACS-30 control system so no additional protection is required.

TABLE 3: MAXIMUM CIRCUIT LENGTH IN FEET (METERS)

| Breaker Size | HWAT-R2 |
|--------------|-----------|
| 15 Amp | 250 (75) |
| 20 Amp | 330 (100) |
| 30 Amp | 500 (150) |

7.3 Electrical Loading

Over-current devices are selected according to the heating cable type, supply voltage, and circuit length to allow for start-up. The design specifies the size and type of over-current device. Piping systems are seldom installed exactly as the drawings show. If changes are made, make sure that all circuit lengths comply with Table 3.

7

Power Supply and Electrical Protection

7.4 Ground-Fault Protection

If the heating cable is improperly installed, or physically damaged to the point that water contacts the bus wires, sustained arcing or fire could result. If arcing does occur, the fault current may be too low to trip conventional circuit breakers. nVent, the U.S. National Electrical Code, and the Canadian Electrical Code require both ground-fault protection of equipment and a grounded metallic covering on all heating cables. All HWAT heating cables meet the metallic covering requirements. Ground-fault protection must be provided by the installer.

 **WARNING:** To minimize the danger of fire from sustained electrical arcing if the heating cable is damaged or improperly installed, and to comply with nVent requirements, agency certifications, and national electrical codes, ground-fault equipment protection must be used on each heating cable branch circuit. Arcing may not be stopped by conventional circuit breakers.

 **WARNING:** Disconnect all power before making connections to the heating cable.

8

Commissioning and Preventive Maintenance

nVent requires a series of commissioning tests be performed on the HWAT system. These tests are also recommended at regular intervals for preventive maintenance. Results must be recorded and maintained for the life of the system, utilizing the "Installation and Inspection Record" (refer to Section 11). Submit this manual with initial commissioning test results to the owner.

Ensure that your water heater and mixing valve temperature are set at your desired pipe maintain temperature.



Important: Exceeding 185°F (85°C) for HWAT-R2 will decrease the power output of the heating cables over time.

8.1 Tests

A brief description of each test is found below. Detailed test procedures are found in Section 9.

Visual inspection

Visually inspect the pipe, insulation, and connections to the heating cable for physical damage. Check that no moisture is present, electrical connections are tight and grounded, insulation is dry and sealed, and control and monitoring systems are operational and properly set. Damaged heating cable must be replaced. Once the heating cable is installed any repairs to pipes should be done very carefully. The heater must be shielded from excessive heat. Temperatures greater than 185°F will permanently damage the affected section of heater. Damage due to excessive external heat may or may not effect the operation of the entire circuit. A torch must not be used on the pipe, pipe hangers, or riser clamps after the heating cable has been installed on the pipe because this can cause permanent damage to the heating cable (even if it does not appear to be burned). Use a saw, not a torch, to cut riser clamps. If use of a torch is unavoidable, cut the fiberglass tape that holds the HWAT cable to the pipe on either side of the area to be heated, and pull the cable away from the pipe. Make sure you do not cut the HWAT cable. Shield the cable from the flame. Charred or damaged cable must be replaced to avoid the risk of arcing or fire.

8

Commissioning and Preventive Maintenance

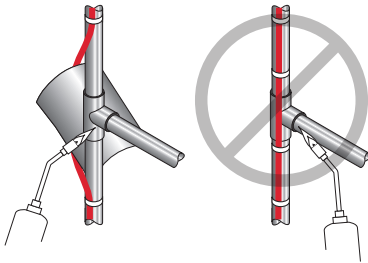

Figure 17: Shielding the cable from the flame

Circuit length verification (capacitance test)

The installed circuit length is verified through a capacitance measurement of the HWAT heating cable. Compare the calculated installed length against the system design. If the calculated length is shorter than the system design, confirm all connections are secure and the grounding braid is continuous.

Insulation Resistance

Insulation Resistance (IR) testing is used to verify the integrity of the heating cable inner and outer jackets. IR testing is analogous to pressure testing a pipe and detects if a hole exists in the jacket.

Power check

The power check is used to verify that the system is generating the correct power output. This test can be used in commissioning to confirm that the circuit is functioning correctly. For on-going maintenance, compare the power output to previous readings.

The heating cable power output per foot is calculated by dividing the total wattage by the total length of a circuit. The current, voltage, operation temperature and length must be known. Circuit length can be determined from “as built” drawings, meter marks on the cable or with the capacitance test. The watts per foot can be compared to the heating cable output in Section 9 for an indication of heating cable performance:

8

Commissioning and Preventive Maintenance

Ground-fault test

Test all ground-fault breakers, including those integral to the HWAT-ECO-GF and ACS-30 controllers, per manufacturer's instructions.

Cable and Connection Continuity

Cable and connection continuity test verifies all the electrical connections are made properly. nVent recommends conducting this test as the cable is installed to identify any potential problems immediately. This test can also be conducted after the entire cable run is installed but before end seals are applied.

8.2 Preventative Maintenance

Recommended maintenance for HWAT systems consists of performing the system tests for commissioning, and on a regular basis Procedures for these tests are described in Section 9. systems should be checked each year. If the HWAT system fails any of the tests, refer to Section 10 for trouble shooting assistance. Make the necessary repairs and replace any damaged cable immediately. De-energize all circuits that may be affected by maintenance. Protect the heating cable from mechanical or thermal damage during maintenance work.

Maintenance records

The "Installation and Inspection Record," (refer to Section 11) should be filled out during all maintenance and repairwork and kept for future reference.

Repairs

Use only HWAT heating cable, HWAT-ECO-GF or ACS-30 controller, and RayClic connection kits when replacing any damaged heating cable system. Repair the thermal insulation to original condition or replace with new insulation, if damaged. Retest the system after all repairs or replacements.

 **WARNING: Damage to cables or components can cause sustained electrical arcing or fire. Do not attempt to repair damaged heating cable. Do not energize cables that have been damaged by fire. Replace damaged cable at once by removing the entire damaged section and splicing in a new length using the appropriate RayClic splice kits.**

9

Test Procedures

9.1 System Tests

The following tests must be done after installing the RayClic connection kits, but before the thermal insulation is applied to the pipe:

1. Visual inspection
2. Insulation resistance test

After the thermal insulation has been installed on the pipe, the following tests must be performed:

1. Visual inspection
2. Insulation resistance test
3. Circuit length verification (capacitance test)
4. Power test
5. Temperature test

All test procedures are described in this manual. It is the installer's responsibility to perform these tests or have an electrician perform them. Record the results in the Installation and Inspection Record in Section 11.

1. Visual inspection test

- Check inside all power, splice and tee kits for proper installation, overheating, corrosion, moisture, or loose connections.
- Check the electrical connections to ensure that ground and bus wires are insulated over their full length.
- Check for damaged, missing or wet thermal insulation.
- Check that end seals, splices, and tees are properly labeled on insulation cladding.
- Check HWAT-ECO-GF or ACS-30 controller for proper setpoint and operation. Refer to the HWAT-ECO-GF Installation and Operation Manual or ACS-30 Programming Guide for details.

2. Insulation Resistance test

Frequency

Insulation resistance testing is required during the installation process, and as part of regularly scheduled maintenance, as follows:

9

Test Procedures

- Before installing the cable
- Before installing components
- Before installing the thermal insulation
- After installing the thermal insulation
- Prior to initial start-up (commissioning)
- As part of the regular system inspection
- After any maintenance or repair work

Procedure

Insulation resistance testing (using a megohmmeter) should be conducted at three voltages; 500, 1000, and 2500 Vdc. Potential problems may not be detected if testing is done only at 500 and 1000 volts. First measure the resistance between the heating cable bus wires and the braid (Test A), then measure the insulation resistance between the braid and the metal pipe (Test B). Do not allow test leads to touch junction box, which can cause inaccurate readings.



Important: System tests and regular maintenance procedures require that insulation resistance testing be performed. Test directly from the HWAT-ECO-GF, ACS-30 or the junction box closest to the RayClic-PC.



WARNING: Fire hazard in hazardous locations. Insulation resistance test can produce sparks. Be sure there are no flammable vapors in the area before performing this test.

Insulation resistance criteria

A clean, dry, properly installed circuit should measure thousands of megohms, regardless of the heating cable length or measuring voltage (500–2500 Vdc). The following criteria are provided to assist in determining the acceptability of an installation where optimum conditions may not apply.

- All insulation resistance values should be greater than 1000 megohms. If the

9

Test Procedures

reading is lower, consult Section 10, Troubleshooting Guide.

⚡ Important: Insulation resistance values for Test A and B for any particular circuit should not vary more than 25 percent as a function of measuring voltage. Greater variances may indicate a problem with your heat-tracing system, confirm proper installation and/or contact nVent for assistance.

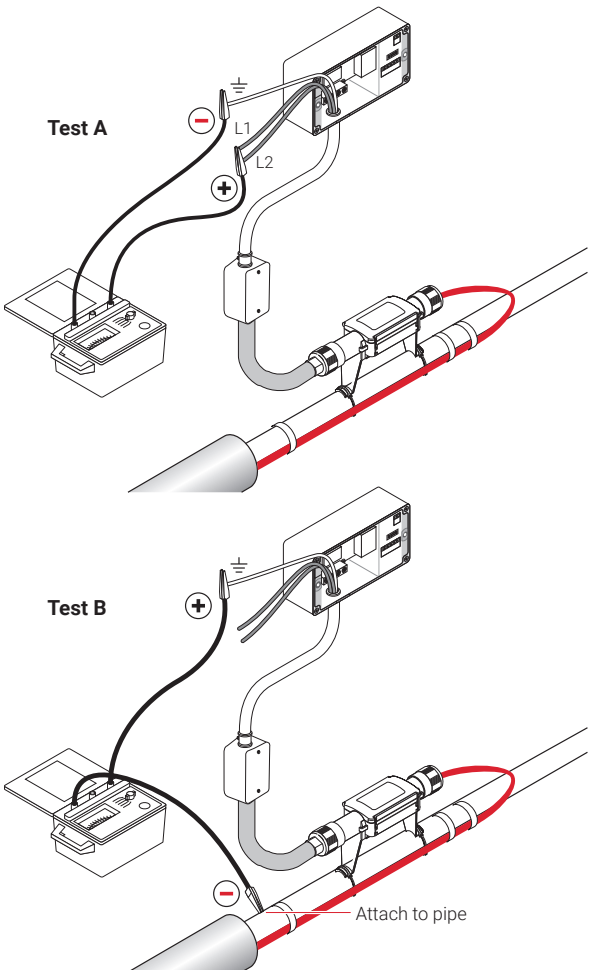

9

Test Procedures

Figure 18: Insulation resistance test

Insulation Resistance test procedure

1. De-energize the circuit.
2. Disconnect the HWAT-ECO-GF or ACS-30 controller if installed.
3. Disconnect bus wires from terminal block.
4. Set test voltage at 0 Vdc.
5. Connect the negative (–) lead to the heating cable metallic braid or RayClic green wire.
6. Connect the positive (+) lead to both heating cable bus wires or RayClic black wires.
7. Turn on the megohmmeter and set the voltage to 500 Vdc; apply the voltage for 1 minute. Meter needle should stop moving. Rapid deflection indicates a short. Record the insulation resistance value in the Inspection Record.
8. Repeat Steps 4–7 at 1000 and 2500 Vdc.
9. Turn off the megohmmeter.
10. If the megohmmeter does not self-discharge, discharge phase connection to ground with a suitable grounding rod. Disconnect the megohmmeter.
11. Repeat this test between braid and pipe.
12. Reconnect bus wires to terminal block.
13. Reconnect the HWAT-ECO-GF controller.

3. Circuit length verification (capacitance test)

Connect the capacitance meter negative lead to both bus wires and the positive lead to the braid wire. Set the meter to the 200nF range. Multiply this reading by the Capacitance factor for the correct heating cable shown below to determine the total circuit length.

Length (ft or m) = Capacitance (nF) x
Capacitance factor (ft or m/nf)

9

Test Procedures

TABLE 4: CAPACITANCE FACTORS

| Heating Cable | Capacitance Factor | |
|---------------|--------------------|------|
| | ft/nF | m/nF |
| HWAT-R2 | 5.8 | 1.8 |

Compare the calculated circuit length to the design drawings and circuit breaker sizing tables.



Figure 19: Capacitance test

4. Power check

The power output of self-regulating heating cable is temperature-sensitive and requires the following special procedure to determine its value:

 **Important:** Run hot water through the piping system before powering the HWAT-R2 heating cable. This will ensure the system is at a uniform pipe temperature. Do not power the system when the pipe temperature is below 50F(10C).

1. Power the heating cable and allow it to stabilize for 2 hours, then measure current and voltage at the junction box. If a controller is used, refer to details below.
2. Measure the pipe temperature under the thermal insulation at several locations.
3. Calculate the power of the heating cable by multiplying the current by the input voltage and dividing by the actual circuit length.

$$\text{Power (w/ft or m)} = \frac{\text{Volts (Vac)} \times \text{Current (A)}}{\text{Length (ft or m)}}$$

The power calculated should be similar to the value generated by:

$$\text{Rated Power (w/ft or m)} = \text{Volts (Vac)} \times \text{Rated Current}$$

9

Test Procedures

TABLE 5: RATED CURRENT (A/FT OR M)

| Heating Cable | Pipe Temperature | Rated Current (A/ft or m) |
|---------------|------------------|---------------------------|
| HWAT-R2 | 140°F (60°C) | .017 (.056) |

5. Temperature test

When testing an HWAT system for temperatures it is important to test in an appropriate sequence. Testing should start at the point of use closest to the water heater and progress out.

Testing should be done after a minimum of 4 hours of no water usage. This will ensure that the temperatures indicated are not due to flow conditions. It is a good idea to turn off all cold water valves to eliminate the possibility of introducing cold water to the hot side via a cross connection.

The following example illustrates a typical temperature test sequence for an HWAT system.

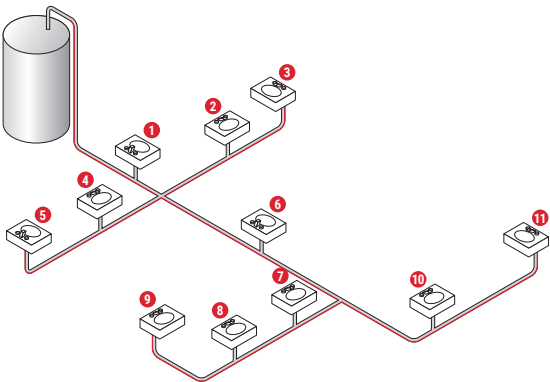

Figure 20: Typical temperature test sequence

9

Test Procedures

9.2 Fault Location Tests

There are three methods used for finding a fault within a section of heating cable:

1. Ratio method
2. Conductance method
3. Capacitance method

1. Ratio method

The ratio method uses resistance measurements taken at each end of the heating cable to approximate the location of a **bus wire short**. A shorted heating cable could result in a tripped circuit breaker. If the resistance can be read on a standard ohm meter this method can also be used to find a fault from a bus wire to the ground braid. This type of short would trip a GFPD and show a failed reading. Measure the bus-to-bus heating cable resistance at each end (measurement A and measurement B) of the suspected section.

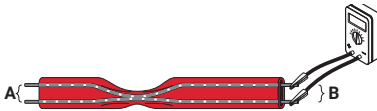

Figure 21: Cable resistance measurement test

The approximate location of the fault, expressed as a percentage of the heating cable length from the front end, is:

$$\text{Fault location: } D = \frac{A}{(A + B)} \times 100$$

$$\begin{aligned} \text{Example: } A &= 1.2 \text{ ohms} \\ B &= 1.8 \text{ ohms} \end{aligned}$$

$$\begin{aligned} \text{Fault location: } D &= 1.2 / (1.2 + 1.8) \times 100 \\ &= 40\% \end{aligned}$$

The fault is located 40% into the circuit as measured from the front end.

To locate a low resistance ground fault, measure between bus and braid.

9

Test Procedures



Figure 22: Low resistance ground-fault test

The approximate location of the fault, expressed as a percentage of the heating cable length from the front end is:

$$\text{Fault location: } D = \frac{A}{(A + B)} \times 100$$

$$\begin{aligned} \text{Example: } A &= 1.2 \text{ ohms} \\ B &= 1.8 \text{ ohms} \end{aligned}$$

$$\begin{aligned} \text{Fault location: } D &= 1.2 / (1.2 + 1.8) \times 100 \\ &= 40\% \end{aligned}$$

The fault is located 40% into the circuit as measured from the front end

2. Conductance method

The conductance method uses the core resistance of the heating cable to approximate the location of a fault when the heating cable has been severed and the bus wires have not been shorted together. A severed cable may result in a cold section of pipe and may not trip the circuit breaker.

Measure the bus-to-bus heating cable resistance at each end (measurement A and measurement B) of the suspect section. Since self-regulating cables are a parallel resistance, the ratio calculations must be made using the conductance of the cable.



Figure 23: Cable resistance measurement

The approximate location of the fault, expressed as a percentage of the heating cable length from the front end, is:

9

Test Procedures

9.3 Cable and Connection Continuity Test:

To complete a continuity test it is best to start the installation with a power connection kit. A completed power connection kit allows for easier testing. The bus wires and braid can be temporarily connected together at the power connection end (Figure 24) and resistance can be tested at the other end as each additional component is added to the system.

Procece:

1. De-energize the circuit
2. Disconnect cable bus wires and ground wire
3. Temporarily connect cable bus wires and ground wire together with a wire nut (Figure 24)

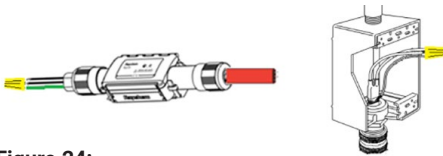

Figure 24:

4. Go to the end of the heating cable run and measure resistance using an ohm meter.
5. A resistance reading should be taken for each bus wire to braid and then bus wire to bus wire. Braid to A should equal Braid to B, A to B will be slightly higher. (Figure 25)

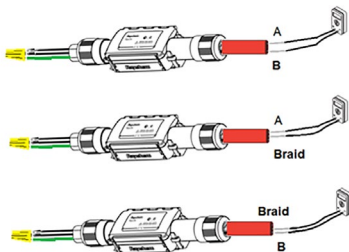



Figure 25:

9

Test Procedures

6. If a higher reading is measured on one of the tests all connections are not completed and there is not continuity for one or both of the bus wires.
7. If resistance values of braid to A and braid to B are not within 20% of each other inspect all connection kits (splice, tee, and cross) between the power connection and the cable end that is being tested.
8. If resistance values of braid to A and braid to B are within 20% of each other the cable continuity is intact. Continue with system installation.
9. Repeat test procedures for all branch lines to verify entire heat tracing circuit.
10. After entire circuit passes continuity test, remove wire nut on power connection kit and connect to heat trace controller.

 **Note:** Readings can be taken at a previously installed RayClic power, splice, tee or cross connection by using the test ports available inside the component (see figure 26). Testing at a RayClic will only confirm continuity to the previous components; it will not verify continuity to the cable end seal.

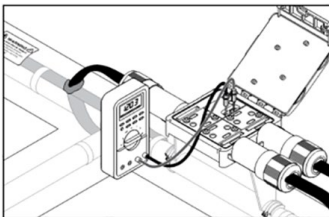

Figure 26:

10

Troubleshooting Guide

Symptom

Probable Causes

Low water temperature

Insulation is wet, or missing.

HWAT-ECO-GF controller lowered the pipe setpoint temperature because water heater is cold.

Ambient too low.

Improper voltage applied.

Improper insulation thickness used.

HWAT-ECO-GF or ACS-30 was set incorrectly.

Cold water is being introduced into the hot water system.

Tripped circuit breaker.

Symptom

Probable Causes

Low or no power output

Low or no input voltage applied.

The circuit is shorter than the design shows, due to splices or tees not being connected, or the heating cable having been severed.

Improper component connection causing a high-resistance connection.

HWAT-ECO-GF or ACS-30 set wrong or incorrectly wired.

The heating cable has been exposed to excessive temperature, moisture or chemicals.

10

Troubleshooting Guide

Corrective Action

Remove wet insulation and replace with dry insulation, and secure it with proper weatherproofing.

Verify the HWAT-ECO-GF water heater setting, water heater temperature, and sensor placement; and correct as required.

Set the HWAT-ECO-GF or ACS-30 to the appropriate ambient temperature.

Refer to the HWAT-ECO-GF Installation and Operation Manual (H60223) to set the HWAT-ECO-GF to the correct voltage (208–277 V).

Contact your nVent representative to confirm the design and modify as recommended.

Refer to the HWAT-ECO-GF Installation and Operation Manual (H60223) or ACS-30 Programming Guide (H58692) for the correct settings.

Verify that the plumbing fixtures and valves are operating properly.

See "Circuit breaker trips" section of this Troubleshooting Guide.

Corrective Action

Repair the electrical supply lines and equipment.

Check the routing and length of heating cable (use "as built" drawings to reference actual pipe layout). Connect all splices or tees. Locate and replace any damaged heating cables. Then recheck the power output.

Examine RayClic connection kits for proper installation. Check for loose wiring connections and rewire if necessary.

Refer to the HWAT-ECO-GF Installation and Operation Manual (H60223) or ACS-30 Programming Guide (H58692) for the correct settings.

Check the pipe temperature. Verify heater selection. Check the power output of the heating cable per the design vs. actual. Reduce pipe temperature if possible or contact your nVent representative to confirm design.

Replace damaged heating cable. Check the pipe temperature. Check the power output of heating cable.

10

Troubleshooting Guide

Symptom

Probable Causes

Circuit breaker trips

Circuit breaker is undersized.

Connections and/or splices are shorting out.

Physical damage to heating cable is causing a direct short.

Bus wires are shorted at the end.

Circuit lengths too long.

Nick or cut exists in heating cable or power feed wire with moisture present or moisture in connections.

GFPD is undersized (5 mA used instead of 30 mA) or miswired.

Symptom

Probable Causes

Low or inconsistent insulation resistance

Nicks or cuts in the heating cable.

Short between the braid and heating cable core or the braid and pipe.

Arcing due to damaged heating-cable insulation.

Moisture present in the components.

Test leads touching the junction box.

10

Troubleshooting Guide

Corrective Action

Recheck the design for startup temperature and current loads. Do not exceed the maximum circuit length for heating cable used. Replace the circuit breaker, if defective or improperly sized.

Visually inspect the RayClic connection systems. Replace if necessary.

Check for damage around the valves and any area where there may have been maintenance work. Replace damaged sections of heating cable.

Check the end seal to ensure that bus wires are not shorted. If a dead short is found, the heating cable may have been permanently damaged by excessive current and may need to be replaced.

Separate the circuit into multiple circuits that do not exceed max circuit lengths.

Replace the heating cable, as necessary. Dry out and reseal the connections and splices. Using a megohmmeter, retest insulation resistance.

Corrective Action

If heating cable is not yet insulated, visually inspect the entire length for damage, especially at elbows and flanges and around valves. If the system is insulated, remove the connection kits one-by-one to isolate the damaged the section.

Replace damaged heating-cable sections.

If moisture is present, dry out the connections and retest. Be sure all conduit entries are sealed, and that condensate in conduit cannot enter power connection boxes. If heating-cable core or bus wires are exposed to large quantities of water, replace the heating cable. (Drying the heating cable is not sufficient, as the power output of the heating cable can be significantly reduced.)

Clear the test leads from junction box and restart.

11

Troubleshooting Guide

nVent Installation and Inspection Record

Test Date: _____

Facility: _____

Commission Inspection date: _____

Inspected by (Name): _____

Panel and Circuit Breaker Number: _____

Water heater/mixing valve temperature setting (°F) _____

Designed circuit length (ft): _____

Capacitance test

nF: _____

Cap factor (Table 4): _____

nF X Cap Factor= _____ (ft/m)

HWAT-ECO-GF setting: _____

Heating cable type: _____

Voltage: _____

Ambient Temp: _____

Set point: Maintain _____

Power factor _____

Test Date: _____

Visual Inspection

Confirm 30-mA ground-fault device (proper rating/function) _____

Confirm all electrical connections in the RayClic and HWAT-ECO-GF are tight and wires secure.

Visual inspection inside connection boxes for overheating, corrosion, moisture, loose connections and other problems.

Proper electrical connection, ground, and bus wires insulated over full length.

Correct thermal insulation used for each pipe size (Reference Table 2) _____

Damaged or missing thermal insulation for the entire hot water piping system. _____

Covered end seals, splices, and tees properly labeled on insulation. _____

Check HWAT-ECO-GF for moisture, corrosion, setpoint, switch operation _____

Insulation resistance test

Bus to braid (Test A) 500 Vdc _____

1000 Vdc _____

2500 Vdc _____

Braid to pipe (Test B) 500 Vdc _____

1000 Vdc _____

2500 Vdc _____

Power and temperature check

Panel voltage (V) _____

Circuit voltage (V) _____

Circuit end (V) _____

Circuit amps after 2 hours (A) _____

Pipe temperature (°F) _____

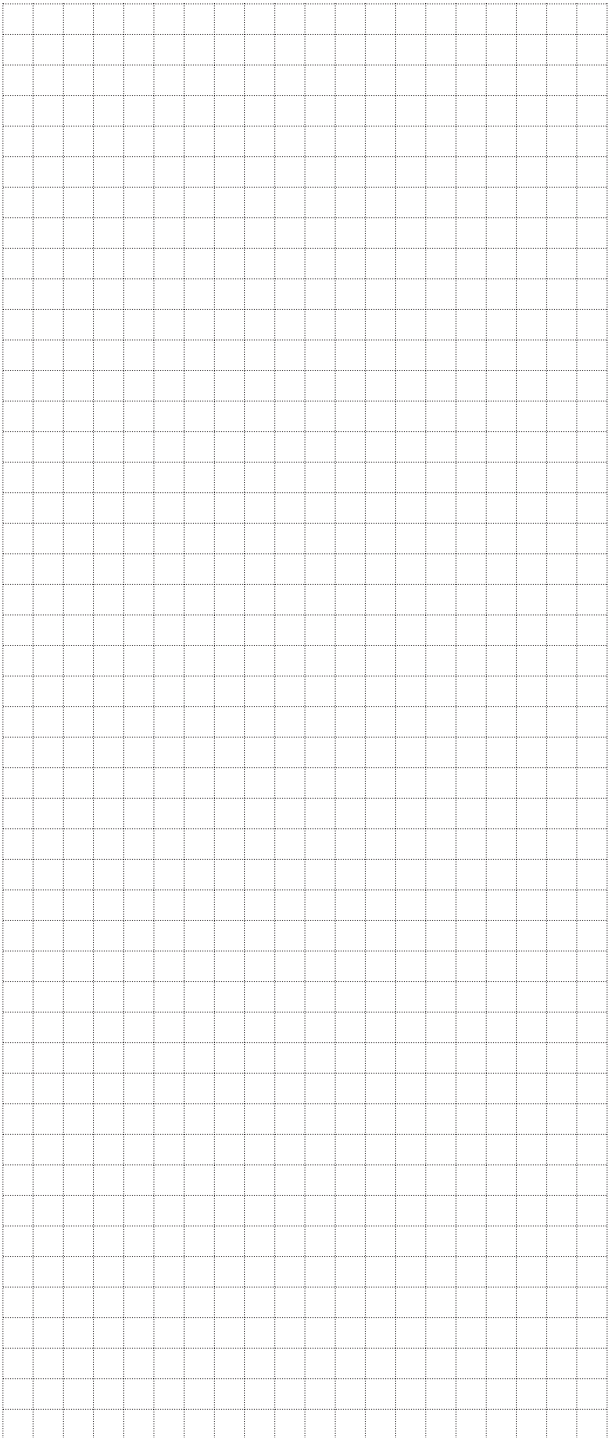

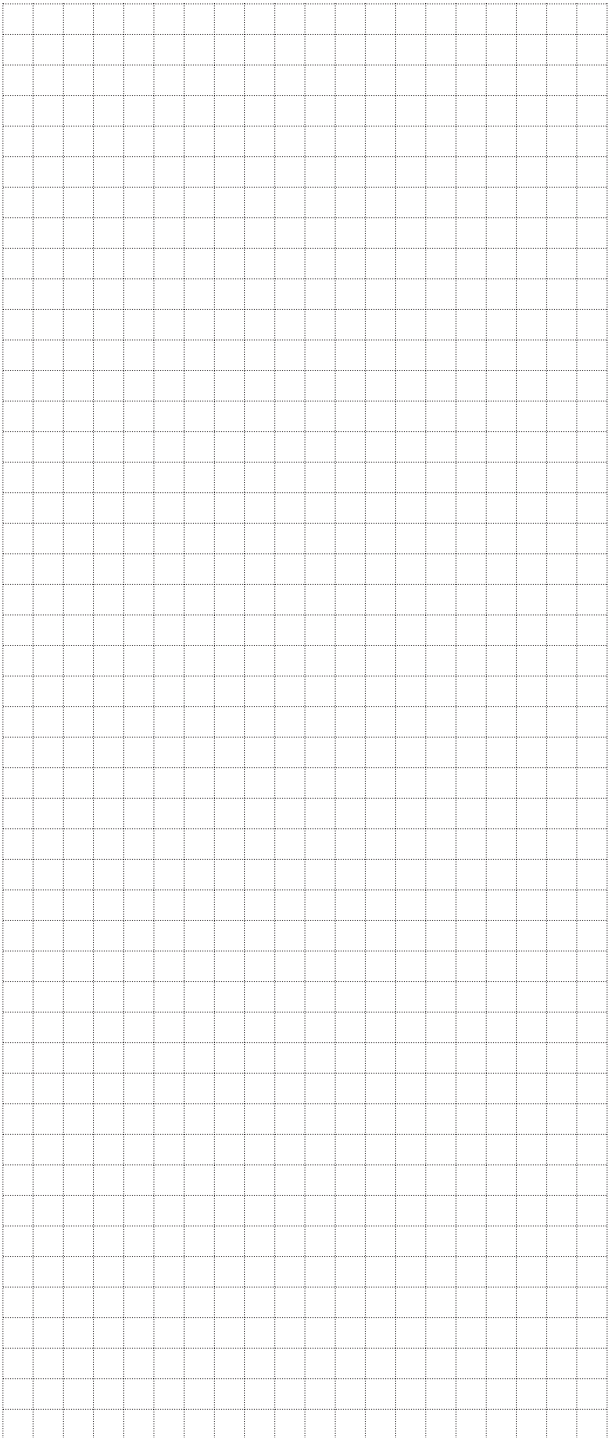

North America

Tel +1.800.545.6258

Fax +1.800.527.5703

thermal.info@nvent.com



nVent.com

©2019 nVent. All nVent marks and logos are owned or licensed by nVent Services GmbH or its affiliates. All other trademarks are the property of their respective owners. nVent reserves the right to change specifications without notice.

RAYCHEM-IM-H57548-HWATsystem-EN-1907