



Quality People. Building Solutions.

Comfort Systems USA (Arkansas), Inc.
P.O. Box 16620
Little Rock, AR 72231
Phone 501-834-3320
Fax 501-834-5416

Date: 5/23/2023
Return Request: 6/2/2023
Project: Farm Credit Office
Supplier: Split System
Submittal: Samsung
Submittal Number: 23 81 74-01
Drawing # and Installation: Mechanical Drawings

ARCHITECT

Hight Jackson
5201 W. Village Parkway, Suite 300
Rogers, AR 72758
479-464-4965

ENGINEER

HAS Engineering
7405 Ellis Rd.
Fort Smith, AR 72916
479-452-8922

GENERAL CONTRACTOR

Nabholz
612 Garland St.
Conway, AR 72032
501-505-5800

MECHANICAL SUBCONTRACTOR

Comfort Systems USA (Arkansas), Inc.
9924 Landers Rd.
N. Little Rock, AR 72117
501-834-3320

Notes:

CSUSA PROJECT NO.
23-1013
jon@comfortar.com



IOM

PRODUCT	SAMSUNG
MANUFACTURER	SAMSUNG
JOB NAME	FARM CREDIT
LOCATION	RUSSELLVILLE
ENGINEER	
CONTRACTOR	CSUSA
CONTRACTOR POC	JON DAVIS
DATE	1/31/2024
SUBMITTED BY	ERIC BLAYLOCK

Air conditioner

Installation manual

AR**BSFC***

- Thank you for purchasing this Samsung air conditioner.
- Before operating this unit, please read this user manual carefully and retain it for future reference.

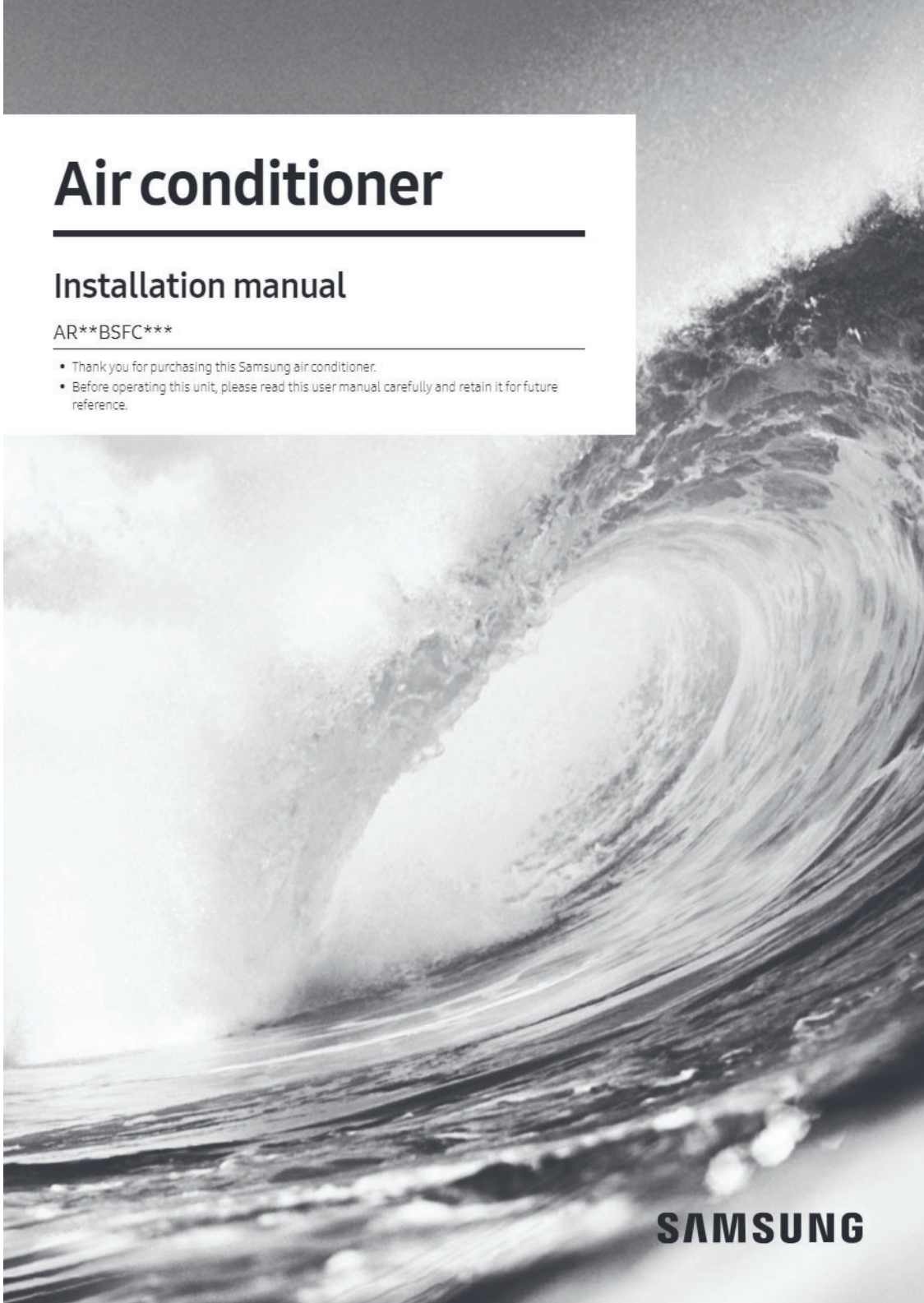

SAMSUNG

Contents

Safety Information	3
Safety Information	3
Installation	6
Preparation	6
Step 1-1 Viewing the typical installation	6
Step 1-2 Verifying model numbers	7
Step 1-3 Choosing the installation location	8
Step 1-4 Unpacking	11
Step 1-5 Preparing materials and tools	12
Indoor Unit Installation	14
Step 2-1 Attaching the mounting bracket to the wall	14
Step 2-2 Drilling the wall penetration	14
Step 2-3 Connecting the refrigerant pipes	15
Step 2-4 Connecting the power and communication cables	16
Step 2-5 Optional: Extending the power cable	17
Step 2-6 Connecting the drain hose	18
Step 2-7 Taping the pipes, cables, and drain hose	19
Outdoor Unit Installation	20
Step 3-1 Mounting the outdoor unit	20
Step 3-2 Connecting the cables and the pipes	21
Installation Inspection and Testing	22
Step 4-1 Performing a drain leak test	22
Step 4-2 Performing pressure tests using nitrogen	22
Step 4-3 Evacuating the system	23
Step 4-4 Adding refrigerant (if needed)	24
Step 4-5 Preparing the system for commissioning	24
Step 4-6 Commissioning the unit	24
Step 4-7 Performing final checks and trial operation	25
Setting the installation options	27
Sub PCB installation(optional)	36

Safety Information

WARNING: Read This Manual

- Read and follow all safety information and instructions before installation, use, or maintenance of this appliance. Incorrect installation, use, or maintenance of this appliance can result in death, serious injury, or property damage. Keep these instructions with this appliance. This manual is subject to change. For the latest version, visit www.samsunghvac.com.

This manual explains how to install a split-system, ductless unit using matched indoor and outdoor units. The manufacturer shall not be responsible for damages arising from the use of non-compatible units.

For information on compatible units and unit specifications, see the submittal document for the applicable model, available at www.samsunghvac.com:

- Submittal AR09BSFCMWKXCV/AR09BSFCMWKNCV
- Submittal AR12BSFCMWKXCV/AR12BSFCMWKNCV
- Submittal AR18BSFCMWKXCV/AR18BSFCMWKNCV
- Submittal AR24BSFCMWKXCV/AR24BSFCMWKNCV

Because the instructions in this manual cover various models, the characteristics of your air conditioner may differ slightly from those described. If you have any questions, please contact your service provider or visit www.samsunghvac.com.

This device complies with Industry Canada license exempt RSS standard(s). Operation is subject to the following two conditions: (1) this device may not cause harmful interference and (2) this device must accept any interference received, including interference that may cause undesired operation. This Class B digital apparatus complies with Canadian ICES-003.

This equipment complies with FCC and IC RSS-102 radiation exposure limits set forth for an uncontrolled environment. This equipment should be installed and operated with minimum distance 23.62 inch (600mm) between the radiator & your body. Any changes or modifications not expressly approved by the manufacturer could void manufacturer's warranty.

This product has been designed and manufactured to meet ENERGY STAR criteria for energy efficiency when matched with appropriate coil components.

However, proper refrigerant charge and proper air flow are critical to achieve rated capacity and efficiency. Installation of this product should follow the manufacturer's refrigerant charging and air flow instructions.

Failure to confirm proper charge and air flow may reduce energy efficiency and shorten equipment life.



Safety Information

Notices and notes

To make you aware of safety messages and highlighted information, we use the following notices and notes throughout this manual:

 **WARNING**

Hazards or unsafe practices that may result in severe personal injury or death.

 **CAUTION**

Hazards or unsafe practices that may result in minor personal injury or property damage.

 **IMPORTANT**

Information of special interest

 **NOTE**

Supplementary information that may be useful

FOR GENERAL

California Proposition 65 Warning (US)

 **WARNING:** Cancer and Reproductive Harm - www.P65Warnings.ca.gov.

 **WARNING**

The installation and testing of this appliance must be performed by a qualified technician.

- The instructions in this manual are not intended as a substitute for proper training or adequate experience in the safe installation of the appliance.

Always install the air conditioner in compliance with current local, state, and federal safety standards.

General information

- The air conditioner should be used only for the applications for which it has been designed: the indoor unit is not suitable to be installed in areas used for laundry.

Installation of the product

- Our units must be installed in compliance with the spaces indicated in the installation manual to ensure either accessibility from both sides or ability to perform routine maintenance and repairs. The units' components must be accessible and that can be disassembled in conditions of complete safety either for people or things. For this reason, where it is not observed as indicated into the Installation Manual, the cost necessary to reach and repair the unit (in safety, as required by current regulations in force) with slings, trucks, scaffolding or any other means of elevation won't be considered in-warranty and will be charged to end user.

Power supply line, fuse, or circuit breaker

- Be sure not to perform power cable modification, extension wiring, and multiple wire connection.
 - It may cause electric shock or fire due to poor connection, poor insulation, or current limit override.
 - When extension wiring is required due to power line damage, refer to "Step 2-5 Optional: Extending the power cable" in the installation manual.

Preparation

Step 1-1 Viewing the typical installation

A typical installation will be similar to the one shown below.

Model	Pipe length			Pipe height
	Minimum	Maximum	Standard for factory charge	Maximum
09***	9.8(3)	65.6(20)	24.6(7.5)	49.2(15)
12***	9.8(3)	98.4(30)	24.6(7.5)	65.6(20)

Unit : ft(m)

Installation

Step 1-2 Verifying model numbers

Check the model numbers on the boxes to make sure that the indoor and outdoor units are compatible with each other. For compatible units, see the model's submittal document, listed on page 5.

Nominal capacity (BTU/hour)	Indoor unit model number	Outdoor unit model number
9000	AR09BSFCMWKNCV	AR09BSFCMWKXCV
12000	AR12BSFCMWKNCV	AR12BSFCMWKXCV
18000	AR18BSFCMWKNCV	AR18BSFCMWKXCV
22000	AR24BSFCMWKNCV	AR24BSFCMWKXCV

Preparation

Step 1-3 Choosing the installation location

If using a multi system, install as described in the installation manual supplied with the outdoor unit.

WARNING

- Verify that a dedicated circuit breaker and a disconnect switch of the appropriate sizes for the air conditioner are preinstalled and available for use. See the submittal document for the model, listed on page 3.
- Verify that the voltage and frequency of the power supply comply with the rated voltage as defined on the unit name plate.
- Verify that a suitable grounding connection is available.
- Do not install this appliance in an environment containing hazardous substances or close to equipment that releases open flames.
- Do not install this appliance near a heater or flammable material.

CAUTION

- The manufacturer shall not be responsible for damage occurring as a result of the wrong voltage being applied to this air conditioner.
- The indoor and outdoor units must be installed in compliance with minimum clearances to ensure that both units are accessible from both sides and can be maintained or repaired. Insufficient clearance may reduce product performance, generate excessive noise, and reduce the life of some unit components.

IMPORTANT

- Any changes or modifications to the installation described in this manual that are not expressly approved by the manufacturer could void the manufacturer's warranty.

To determine where to locate the indoor and outdoor units, you must survey the entire site and consider many variables. The goal is to select locations that comply with all safety precautions while also minimizing the total effort involved.

Indoor unit location requirements

WARNING

- Do not install the unit in a humid, oily, or dusty location or in a location exposed to direct sunlight, water, or rain.
- Make sure that the wall can support the unit weight.

Examine the area that the customer wants to be air conditioned. Consider the following:

- What wall location will meet minimum clearances and provide optimal product performance?
- Will the wall provide adequate support for the unit weight (wall with stud construction or concrete)? If applicable, where are the studs?
- Where will you place the wall penetration for routing the piping bundle (consisting of power and communication cables, refrigerant pipes, and the drain hose) through the wall to the outdoor unit? Will the hole intersect any plumbing or wires in the wall?
- Is the location as close as possible to where the outdoor unit will be installed, to minimize the length of piping and cables?
- Will the condensate drain inside the room, through the wall penetration to the outdoor unit, or be connected to a condensate pump?

NOTE

- This manual covers a typical gravity-drain installation where the drain hose is routed to the outdoor unit through a hole in the wall.

Minimum clearances for the indoor unit

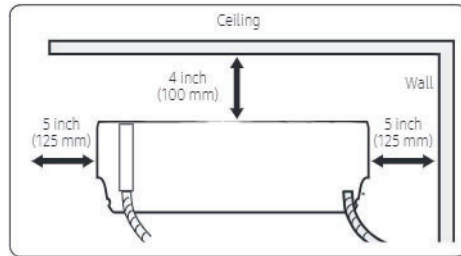

Outdoor unit location requirements

Examine the area where the outdoor unit could be located. Consider the following:

- What location will meet minimum clearances and provide optimal product performance?
- Is there an existing level and hard foundation, such as a concrete pad, that will support the unit weight and produce minimal vibration? Installation on uneven ground may result in abnormal vibrations, noise, or problems with the unit.
- Does the unit need to be mounted on the wall?
- Where are the dedicated circuit breaker and disconnect switch located? How will you connect them to the unit?
- How will you route the piping bundle from the indoor unit? Is the location as close as possible to where the indoor unit will be installed, to minimize the length of piping and cables?
- Will the unit be sheltered from the wind? In a high-wind area, you may need to build a protective fence around the unit.
- Where will the condensate drain?

! WARNING

- The drain location must allow condensate to drain properly and prevent ice from forming on the unit in winter. If a block of ice falls from the unit, it may result in death, serious injury, or property damage. Improper or inadequate draining may result in water overflowing and property damage.

! CAUTION

- Do not connect the drain hose to existing waste pipes as odors may arise.

Installation on an exterior wall

If the outdoor unit must be installed on an exterior wall, you will need an L-bracket to support the unit. This bracket is not included with the unit.

! WARNING

- The wall must be capable of supporting the weight of both the L-bracket and the outdoor unit. If the unit falls, it may result in crushing, electric shock, fire, or explosion that could cause death, severe personal injury, or property damage.

Installation Guide at the seashore

Make sure to follow below guides when installing at the seashore.

- 1 Do not install the product in a place where it is directly exposed to sea water and sea breeze.
 - Make sure to install the product behind a structure (such as building) that can block sea breeze.
 - Even when it is inevitable to install the product in seashore, make sure that product is not directly exposed to sea breeze by installing a protection wall.
- 2 Consider that the salinity particles clinging to the external panels should be sufficiently washed out.
- 3 Because the residual water at the bottom of the outdoor unit significantly promotes corrosion, make sure that the slope does not disturb drainage.
 - Keep the floor level so that rain does not accumulate.
 - Be careful not to block the drain hole due to foreign substance.
- 4 When product is installed in seashore, periodically clean it with water to remove attached salinity.
- 5 Make sure to install the product in a place that provides smooth water drainage. Especially, ensure that the base part has good drainage.
- 6 If the product is damaged during the installation or maintenance, make sure to repair it.

Preparation

- 7 Check the condition of the product periodically.
 - Check the installation site every 3 months and perform anti-corrosion treatment such as R-Pro supplied by SAMSUNG (Code : MOK-220SA) or commercial water repellent grease and wax, etc., based on the product condition.
 - When the product is to be shut down for a long period of time, such as off-peak hours, take appropriate measures like covering the product.
- 8 If the product installed within 1640.4 ft (500 m) of seashore, special anti-corrosion treatment is required.
 - ※ Please contact your local SAMSUNG representative for further details.

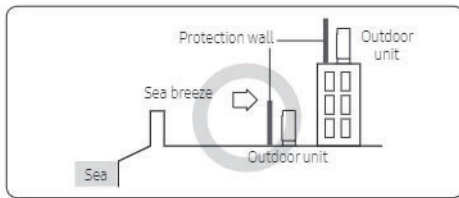
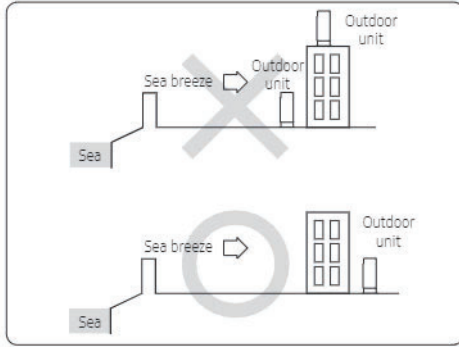

- Protection wall should be constructed with a solid material that can block the sea breeze and the height and width of the wall should be 1.5 times larger than the size of the outdoor unit. (You must secure more than 1.9685 ft (600 mm) of space between the protection wall and the outdoor unit for air circulation.)

Minimum clearances for the outdoor unit

Legends:

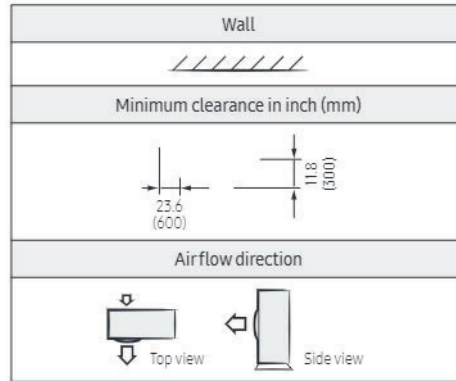

Examples for installing one outdoor unit:

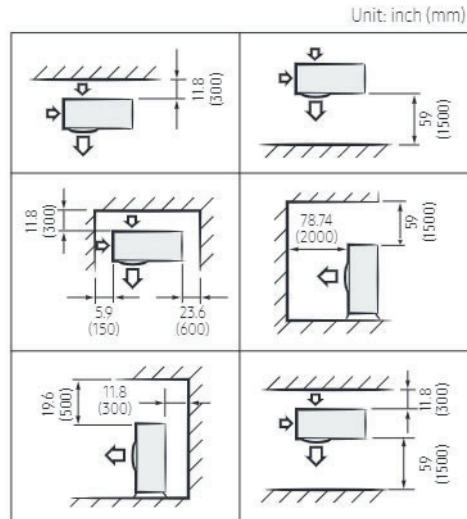

Installation

Examples for installing multiple outdoor units:

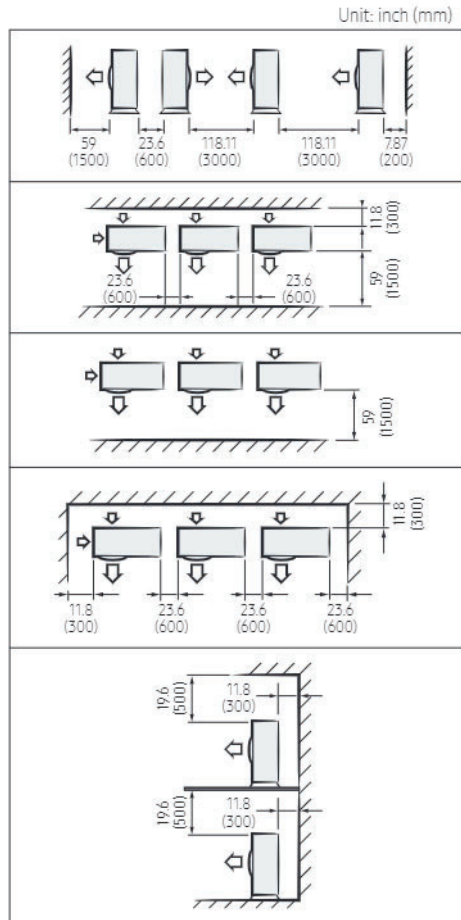

Step 1-4 Unpacking

Upon receipt, inspect the product to verify that it has not been damaged during transport. If the product appears damaged, do not install it and immediately report the damage to your local Samsung distributor.

Packing material must be disposed of in accordance with local regulations.

Unpacking the indoor unit

At the selected indoor unit location:

- 1 Open the indoor unit package.
- 2 Remove the left and right cushions.
- 3 Carefully remove the unit from the package.
- 4 Place the unit on a flat surface where it will be protected from possible damage.

Unpacking the outdoor unit

At the selected outdoor unit location:







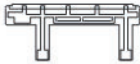
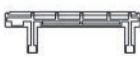

- 1 Remove the package.
- 2 Remove the top cushion.
- 3 Carefully remove the unit from the bottom cushion.
- 4 Place the unit on a flat surface where it will be protected from possible damage.

Preparation

Step 1-5 Preparing materials and tools



Materials in the indoor unit package

Make sure that the indoor unit package contains the following materials:

Mounting bracket (1) **07/09/12/15***** 	Mounting bracket (1) **18/24***** 
Remote control (1) 	Remote control battery (2) 
Quick Guide for User (1) 	Quick Guide for Installer (1) 
Extra M4 x12 tapping screw (2) 	Holder remocon (1) 
PE indoor unit cover (1) 	

Materials in the outdoor unit package

Make sure that the outdoor unit package contains the following materials:

Rubber foot (4) 	Drain plug (1) 
--	---

If using a multi system, install as described in the installation manual supplied with the outdoor unit.

Optional accessories

For information on the accessories that are available for each model, see the submittal documents listed on page 3.

Materials supplied by the installer

Make sure you have all other materials required for the selected installation method and location.

IMPORTANT

- No mounting hardware, tubing, cables, and other materials listed below are included with the appliance.

The required materials will vary, but may include the following:

- 6-ft electrical whip for connecting the power from the installed disconnect switch to the outdoor unit
- UV-resistant vinyl line set tape for the exposed line set
- Lines-set cover and fittings, if used
- Miscellaneous pipe hangers
- Miscellaneous screws and anchors for hanging pipe hangers, the line-set cover, the indoor unit mounting plate, and so on.
- Electrical ring connectors for connecting all power and communication wiring
- Electrical tape
- Refrigerant R-410A if additional refrigerant is required due to line-set length
- Closed cell foam tape insulation (roll)
- Outdoor unit risers or L-brackets for wall installation
- Silicone caulking for sealing the wall penetration
- Rags

Piping and cables

Connecting the indoor and outdoor units requires a premanufactured refrigeration line set (recommended) or a line set assembled by the installer that includes.

- Soft-copper line set insulated with closed-cell foam insulation
- 18 shielded cable, for communication (F1/ F2) wiring
- 14/3 flexible metallic underground cable with green grounding wire, for power wiring from the outdoor unit to the indoor unit
- 5/8-inch ID drain hose with adapter fitting, for gravity drain applications that require an extension
- Make sure that the line set is longer than is needed to reach from the indoor to the outdoor unit, to allow for bends and final connections. For more on pipe lengths, see Step 1-1 Viewing the typical installation on page 6.
- If not using a premanufactured line set:

- Only use insulated seamless refrigeration-grade copper pipe (Cu DHP-type according to ISO1337), degreased and deoxidized, suitable for operating pressures of at least 609 psig (4200 kPa) and for a burst pressure of at least 3002 psig (20700 kPa).
- Do not use sanitary-type copper pipe under any circumstances.
- Use standard cables.

Cable	Terminal	Wire Specification
Power cable	L1, L2, ground	14/3 AWG
Communication cable	F1, F2	16/2 AWG Standard shield cable

NOTE

- This manual does not include instructions for extending cables. If you need to extend the cables, follow local codes.

Tools

Make sure you have the required tools available.

Safety tools

- Service disconnect lock and tag
- Circuit breaker lock and tag
- Safety glasses
- Cut-proof gloves
- Hearing protection
- Hard hat, for use in appropriate areas
- Safety vest, for visibility as required

General tools

- 36-inch spirit level
- 8-inch to 9-inch torpedo level
- Cordless drill

- #2 Phillips-bit driver for cordless drill
- Phillips screw driver
- Slotted screw driver
- Corded hammer drill, for masonry anchors if used
- Masonry drill bit, for masonry anchors if used
- Compact bandsaw, for cutting all thread and/or unistrut channel as required
- Stud finder, for stud-wall construction as required
- 2-5-inch hole saw, standard, or diamond core for concrete or cinder block construction
- Metric hex-key set
- Razor knife
- 25-ft tape measure

Electrical tools

- Clamp-on multimeter, for measuring volt AC, resistance, and amperage
- Non-contact thermometer (may be incorporated into multimeter)
- Wire strippers
- Wire connector crimping tool
- Cutting pliers

Piping tools

- Flaring tool
- Deburring tool
- Piping bender, spring type
- Tubing cutter, imp style
- Tubing cutter, standard style
- Open-end torque wrench (ft.-lbs.)
- Crescent wrench

Refrigeration tools

- Manifold set for R-410A
- 5/16-inch to 1/4-inch flare adapter
- Schrader core removal tool
- 2-stage vacuum pump with oil
- Electronic refrigerant scale (lbs/oz), if additional refrigerant is required due to line length
- Recovery machine with tank, if required
- Micron vacuum gauge
- 1/4-inch vacuum gauge hose tee
- Nitrogen regulator
- Nitrogen cylinder, charged

Installation

Indoor Unit Installation

Step 2-1 Attaching the mounting bracket to the wall

- 1 Hold the mounting bracket against the wall at the selected installation position (Step 1-3 on page 8), making sure that the screw holes align with the center of the studs in the wall. If the screw locations do not align with the studs, use wall anchors.

CAUTION

- The recommended best practice is to attach the mounting bracket directly to the studs in the wall. If you did not find a suitable location with studs (in Step 1-3 on page 8), or if the wall is concrete, you must use wall anchors of a suitable type and weight capacity, and install them according to the manufacturer's instructions. Failure to do so may cause the material surrounding the joints to crumble over time and the screws to be loosened and stripped. This may result in the unit falling from the wall, which could cause physical injury or equipment damage.
- 2 Using a level, make sure that the mounting bracket is level, then mark the location of the screw holes on the wall.
 - 3 If using wall anchors, install them at the screw hole positions, following the manufacturer's instructions.
 - 4 Using six field-supplied mounting screws and anchors (if applicable), attach the bracket to the wall.

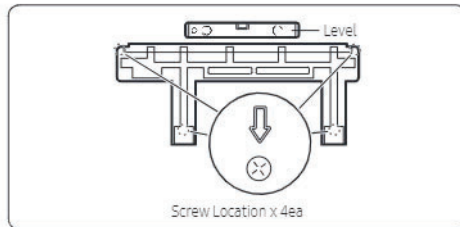

Step 2-2 Drilling the wall penetration

- 1 Determine the position of the hole through which the piping bundle (consisting of power and communication cables, refrigerant pipes, and the drain hose) will pass. Consider the following:
 - The hole inner diameter must be 2.5 inches (65 mm).
 - The recommended hole location is behind the unit so that the hole and the piping bundle will not be visible in the room. The minimum distances between the hole and the mounting bracket are:

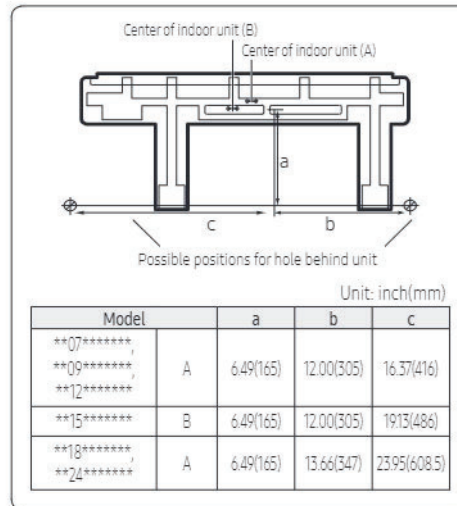

- If the hole cannot be positioned behind the unit, find a position as close to the unit as possible. The piping bundle that exits the unit and extends to the hole will need to be attached to the wall and will be visible inside the room.
- In relation to the bracket shown above, the unit is shipped with the drain hose connection on the right, the drain hose exits the unit on the left, and the refrigerant pipes are bent to exit on the left. Thus, positioning the hole to the left (A/B or outside the unit) requires the least effort. If you position the hole to the right (C/D or outside the unit) or below the unit, you will need to move the drain hose connection to the left and bend the pipes so that the hose and pipes exit to the right or bottom. See the figure in step 3 on page 15.

Installation

- 2 Use a standard 2-5-inch (65-mm) hole saw to drill one hole at the selected location, at a 15° downward angle so that the drain hose will drain properly.

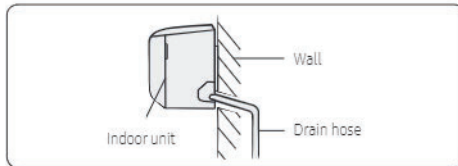

- 3 Based on the hole location, determine where the piping bundle (drain hose, refrigerant pipes, and cables) will exit the unit.

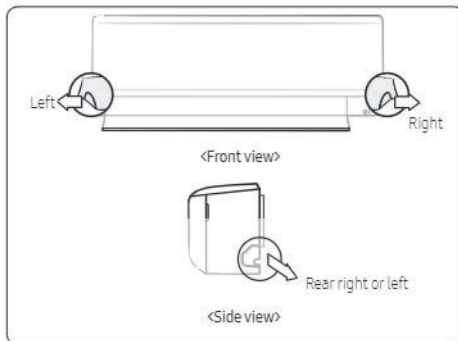

NOTE

- The left or right exit will only be used if the hole is not positioned behind the unit.

Step 2-3 Connecting the refrigerant pipes

Connect indoor and outdoor units with field-supplied copper pipes by means of flare connections. Use insulated seamless refrigeration grade pipe only, (Cu DHP type according to ISO1337), degreased and deoxidized, suitable for operating pressures of at least 4200 kPa and for burst pressure of at least 20700 kPa. Under no circumstances must sanitary type copper pipe be used.

IMPORTANT

- When installing the unit, always connect the refrigerant pipes first, followed by the electrical cables. For disassembly, always disassemble the electric cables before the refrigerant pipes.

Two short refrigerant pipes are already attached to the air conditioner:

- The smaller-diameter pipe is for the high-pressure, two-phase refrigerant.
- The larger-diameter pipe is for the low-pressure refrigerant vapor.

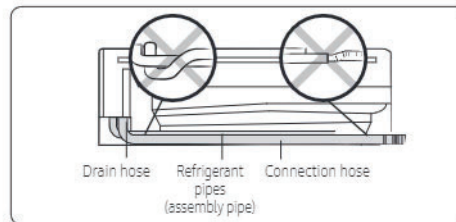

In Step 2-3, step 3 you determined the exit position for the piping bundle. The unit has three knockouts available for the left, right, and bottom exits. When the bundle exits directly from the rear, none of the knockouts are used.

- If the pipes will exit directly from the rear, skip to step 3. Otherwise, cut out the appropriate knockout piece (left, right, or bottom).
- Use a razor knife to clean the cut edges (flashing).
- The left exit is the only position that does not require bending the pipes. For other positions, bend the pipes so that they will exit in the selected exit position.
 - The bending radius should be greater than 4 inch (100 mm).
 - Bend the smaller pipe gradually to prevent kinking. The larger pipe has a preinstalled spring bender to prevent kinking.
 - Make sure that the pipes do not protrude from the back of the unit in a way that will make it difficult to attach the unit to the mounting bracket.
 - For right and bottom exits, pull the pipes out through the selected knockout opening. For left exits, the piping connections will be made in the service space behind the indoor unit (under the cover panel).

Indoor Unit Installation

NOTE

- If you are using the right rear exit, the pipes should be long enough to extend through the wall without needing to connect the line set first. It may be easier to connect the line set outside of the building, after you have bundled the pipes and cables and passed the bundle through the wall. In this case, do not connect the line set now. Instead, complete Step 2-5 through Step 2-9, then go outside and connect the line set as described below.

- Slowly remove the protective caps on the refrigerant pipe connections to relieve the nitrogen holding charge.
- Connect the line set to each pipe.

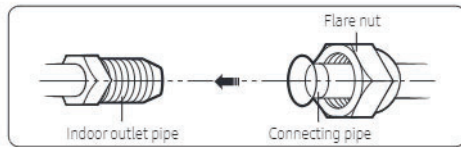

- Hand-tighten the flare nuts to make sure that they do not become stripped.

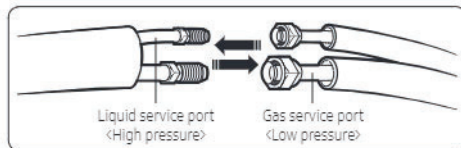

- Torque the flare connections to the following values:

Outer diameter	Torque ft·lb (N·m)
1/4 inch (6.35 mm)	10.1–13.0 (14–18)
3/8 inch (9.52 mm)	25.3–31.1 (34–42)
1/2 inch (12.70 mm)	36.2–44.8 (49–61)
5/8 inch (15.88 mm)	49.9–60.0 (68–82)

CAUTION

- Tighten the flare nuts only to the specified torque. If a flare nut is overtightened, the flare face may crack, causing refrigerant leakage.
- Do not box in or cover the pipe connections. Make sure that the connections are accessible for testing later in the installation process and for future servicing.

- Tape over the end of the pipes so that debris will not enter the piping when it is passed through the wall. The pipes will be insulated later in the installation process.

Step 2-4 Connecting the power and communication cables

If using a multi system, install as described in the installation manual supplied with the outdoor unit.

WARNING

- Do not modify the power cable in any way. Doing so may cause electric shock or fire due to poor connection, poor insulation, or current limit override. Make sure to comply with the technical standards of electrical installations and the wiring regulations in the local area.
- This appliance must be properly grounded. Do not ground the appliance to a gas pipe, plastic water pipe, or telephone line. Failure to comply may result in electric shock, fire, and explosion.

- Connect each wire to its corresponding terminal number.

Cable	Terminals
Power cable	L1, L2, ground
Communication cable	F1, F2

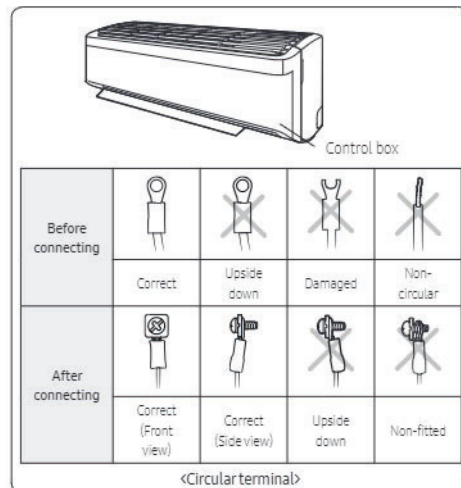

Installation

CAUTION

- Connect the wires firmly so that wires cannot be pulled out. Loose wires can cause the connection to overheat. Each circular terminal must match the size of its corresponding screw in the terminal block.

CAUTION

- For the terminal block wiring, use a wire with a ring terminal socket only. Regular wires without a ring terminal socket may become a hazard as the connections may loosen during operation.

2 Tighten the terminal block screw.

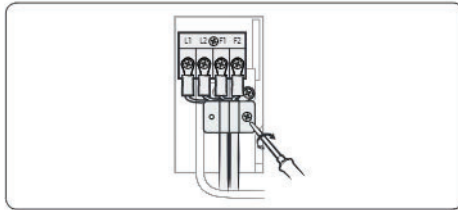

3 In Step 2-3, step 3 you determined the exit position for the piping bundle. If using the left, right, or bottom exits, pass the cables through the selected knockout.

NOTE

- Power supply cords of parts of appliances for outdoor use shall not be lighter than polychloroprene sheathed flexible cord.
- Power & Communication cable shall not exceed 98.42ft(30 m).

Step 2-5 Optional: Extending the power cable

1 Prepare the following tools.

Tools	Spec	Shape
Crimping pliers	MH-14	
Connection sleeve (mm)	0.78x0.25inch (20x06.5mm) (HxOD)	
Insulation tape	Width 0.74inch(19 mm)	
Contraction tube (mm)	2.75x0.31inch (70x08.0 mm) (LxOD)	

2 As shown in the figure, peel off the shields from the rubber and wire of the power cable.

- Peel off 0.79inch (20 mm) of cable shields from the pre-installed tube.

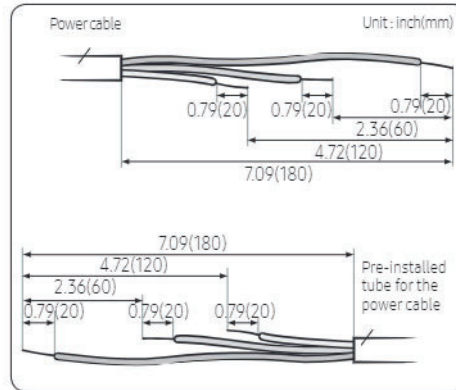

CAUTION

- For information about the power cable specifications for indoor and outdoor units, refer to the installation manual.
- After peeling off cable wires from the pre-installed tube, insert a contraction tube.

3 Insert both sides of core wire of the power cable into the connection sleeve.

- Method 1: Push the core wire into the sleeve from both sides.
- Method 2: Twist the wire cores together and push it into the sleeve.

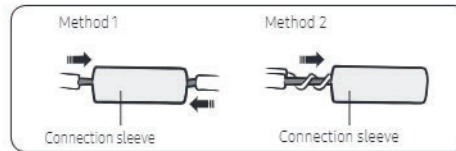

CAUTION

- If cable wires are connected without using connecting sleeves, their contact area becomes reduced, or corrosion develops on the outer surfaces of the wires (copper wires) over a long time. This may cause an increase of resistance (reduction of passing current) and consequently may result in a fire.

Indoor Unit Installation

- 4 Using a crimping tool, compress the two points and flip it over and compress another two points in the same location.
- The compression dimension should be 8.0.

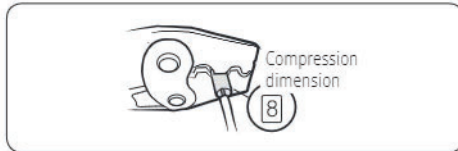

- After compressing it, pull both sides of the wire to make sure it is firmly pressed.

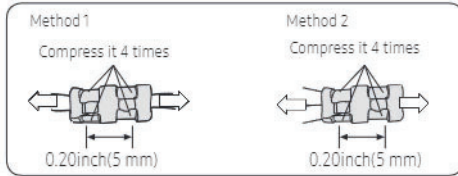

- 5 Apply heat to the contraction tube to contract it.

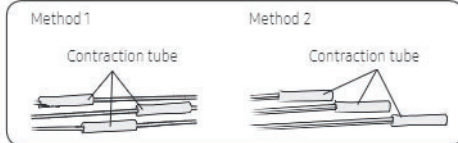

- 6 Wrap it with the insulation tape twice or more and position your contraction tube in the middle of the insulation tape.

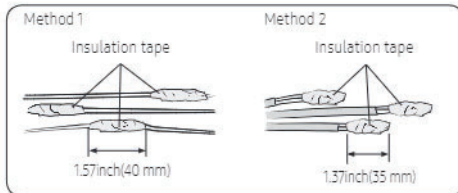

- 7 After tube contraction work is completed, wrap it with the insulation tape to finish. Three or more layers of insulation are required.

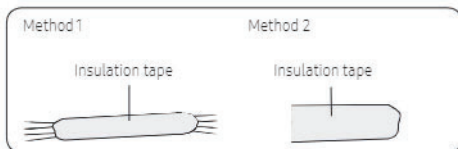

CAUTION

- Make sure that the connection parts are not exposed to outside.
- Be sure to use insulation tape and a contraction tube made of approved reinforced insulating materials that have the same level of withstand voltage with the power cable. (Comply with the local regulations on extensions.)

WARNING

- In case of extending the electric wire, please DO NOT use a round-shaped Pressing socket.
 - Incomplete wire connections can cause electric shock or a fire.

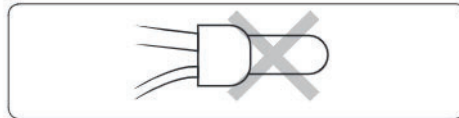

Step 2-6 Connecting the drain hose

- 1 In Step 2-3, step 3 you determined the exit position for the piping bundle. If using the right, bottom, or right rear exit, change the drain hose connection from the right to the left so that the drain hose will lie along the inside of the unit and exit to the right.

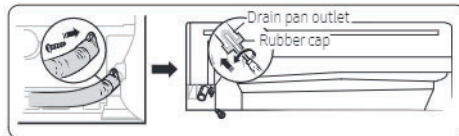

Installation

⚠ CAUTION

- Be careful not to puncture the plug with the screwdriver when installing it.
- 2 If using the left, right, or bottom exit, pass the drain hose through the selected knockout.

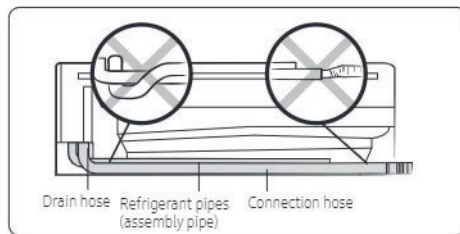

- 3 Connect a 5/8-inch ID extension drain hose to the main drain hose.

⚠ CAUTION

- If the diameter of the connection hose is smaller than the product's drain hose, leakage may occur.

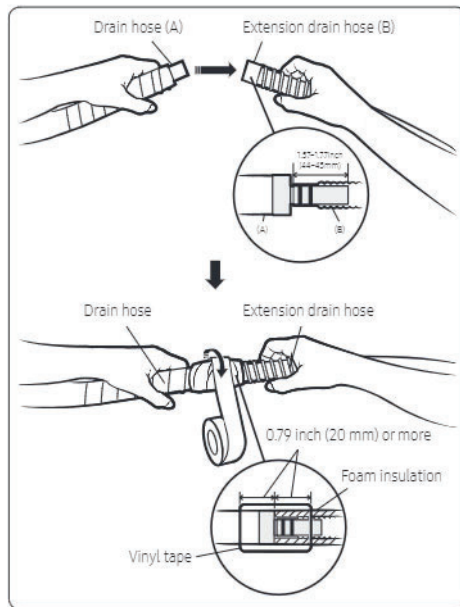

- 4 Do not box in or cover the drain hose connection. It must be accessible for testing later in the installation process and for future servicing.
- 5 If the drain hose is routed inside the room, insulate the hose so that dripping condensation does not damage the furniture or floors.

Step 2-7 Taping the pipes, cables, and drain hose

- 1 Wrap foam insulation around the refrigerant pipes, up to the connection points. The connections must remain accessible for testing later in the installation process. Either leave slits in the insulation or do not cover the connections.

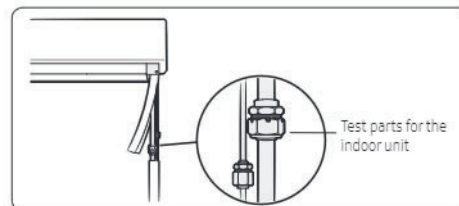
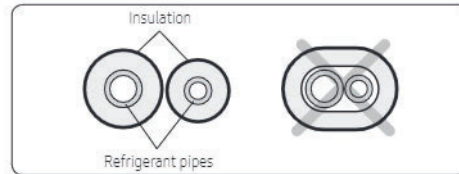

- 2 Make a piping bundle by using vinyl tape to wrap together the refrigerant pipes, power cable, communication cable, and drain hose, up to the connection points. Connection points must remain accessible for testing later in the installation process.

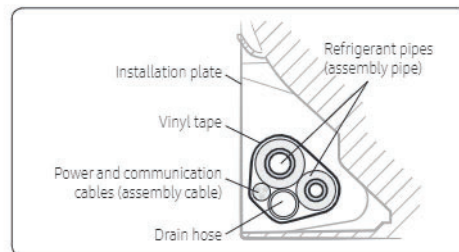

Installation

Outdoor Unit Installation

If using a multi system, install as described in the installation manual supplied with the outdoor unit.

Step 3-1 Mounting the outdoor unit

To promote proper condensate draining, the recommended installation of the outdoor unit is elevated above the ground on a mounting bracket attached to a concrete pad.

In areas where snowfall occurs, the unit must be mounted above the snow line to allow for proper heating. Snow cannot be allowed to collect on top of the unit. For promoting natural drainage in a heavy snow fall area:

- Make space more 3.14 inch (80 mm) between the bottom of the outdoor unit and the ground for installation. (Ensure that the drained water runs off correctly and safely.)
- Allow enough separation distance between the product and the ground.

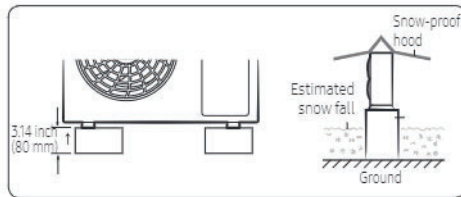

On the ground

- 1 Place the outdoor unit in the selected installation location (Step 1-1 on page 6), ensuring proper clearances and with the arrow on top of the unit pointing away from the wall.
- 2 Clip the rubber feet to the tabs to minimize sound and vibration to the structure.

Unit : ft.(mm)

Model	X	Y
00***	1.66(507)	0.96(292)
12***	2.17(660)	1.12(340)
24***	2.03(620)	1.18(360)

- 3 Level the unit, then use anchor bolts to secure it at the four mounting points.
- 4 For installations in locations that require seismic or hurricane tie downs, comply with local codes.
- 5 If the selected location is exposed to strong winds, install a protective fence around the unit so that the fan can operate correctly.

On a wall

⚠ WARNING

- The unit must be properly secured to the wall. If the unit falls, it may result in crushing, electric shock, fire, or explosion that could cause death, severe personal injury, or property damage.

- 1 At the selected installation location (Step 1-1 on page 6), attach the L-bracket to the wall as follows:
 - Install the bracket as close to the wall as possible.
 - Insert rubber isolators between the bracket and the wall to minimize sound and vibration to the structure. Do not fully compress the isolators.

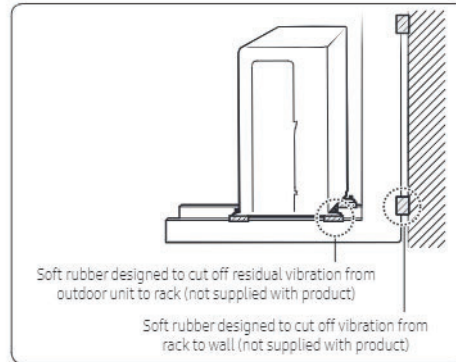

- Make sure that the bracket is level.
 - Use suitable bolts/washers and lock washers.
- 2 Place the outdoor unit on the bracket, ensuring proper clearances and with the arrow on top of the unit pointing away from the wall.
 - 3 Clip the rubber feet to the tabs to minimize sound and vibration to the structure.
 - 4 Level the unit, then use anchor bolts to secure it at the four mounting points.
 - 5 For installations in locations that require seismic or hurricane tie downs, comply with local codes.

Installation

Step 3-2 Connecting the cables and the pipes

- 1 Route the piping bundle to the outdoor unit.
- 2 Use piping clamps to fasten the piping bundle to the foundation or wall.
- 3 Cut the refrigerant pipes to the length needed to reach the pipe connections (located behind the cover panel; see the figure in step 7).

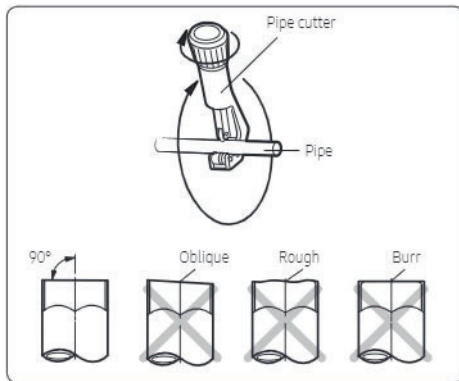

- 4 Remove any burrs, positioning the pipe face down to make sure that the burrs do not get into the pipe.
- 5 Assemble the flare connections on the cut pipe ends.

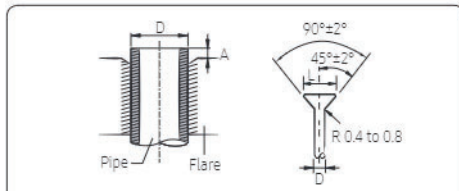

Outer diameter (D)	Depth (A)	Flare dimension (L)
1/4 inch (0.35 mm)	0.051 inch (1.3 mm)	0.3425–0.3583 inch (8.7–9.1 mm)
3/8 inch (9.52 mm)	0.071 inch (1.8 mm)	0.5039–0.5197 inch (12.8–13.2 mm)
1/2 inch (12.70 mm)	0.079 inch (2.0 mm)	0.6378–0.6535 inch (16.2–16.6 mm)
5/8 inch (15.88 mm)	0.087 inch (2.2 mm)	0.7598–0.7756 inch (19.3–19.7 mm)

- 6 Remove the cover panel on the unit.

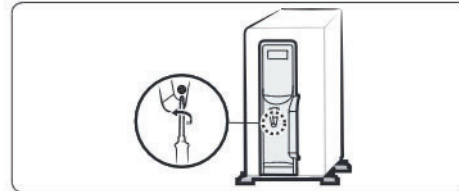

- 7 Remove the service valve caps.

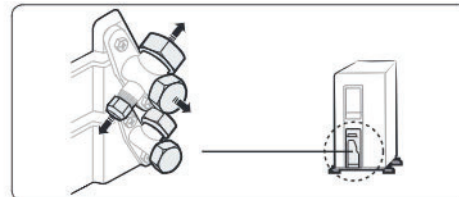

- 8 Connect the pipes to the service valve with the flare nuts. Hand-tighten the nuts to prevent stripping.

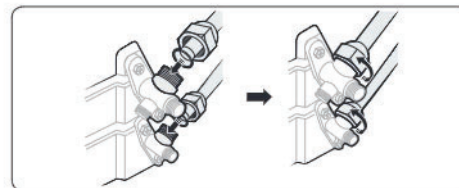

- 9 Torque the flare connections to the values in Step 2-3, step 7 on page 16.

- 10 Connect the power cables and secure with a cable clamp.

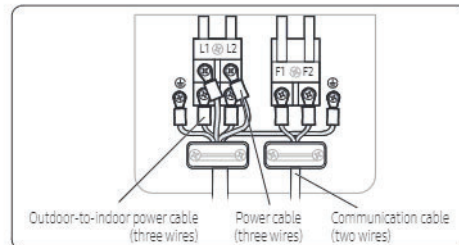

- 11 Connect the outdoor unit power supply cable to the preinstalled disconnect switch.

- 12 Leave the cover panel off for testing later in the installation process.

Installation

Installation Inspection and Testing

Step 4-1 Performing a drain leak test

- 1 Pour water into the drain pan.

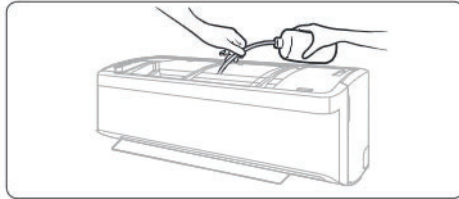

CAUTION

- Make sure that the water does not overflow onto the electrical connection.
- 2 Check for leaks at the drain connection under the cover panel.

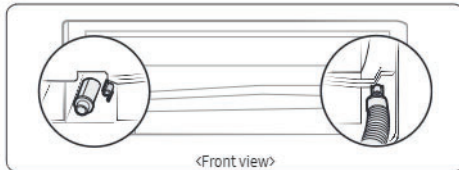

- 3 Make sure that the hose is draining properly at the outdoor unit.

Step 4-2 Performing pressure tests using nitrogen

- 1 Install the red high-side hose of an R-410A-gauge manifold set to the larger liquid/vapor line's service port.
- 2 Attach a pressure regulator to a tank of dry nitrogen.
- 3 Connect the common hose of the gauge manifold set to the pressure regulator's hose connection.
- 4 Open the service port to connect the line set to the gauge manifold set.
- 5 Pressurize the line set and indoor unit with dry nitrogen to 200 psig (adjust at the pressure regulator).
- 6 Using a soap-bubble solution suitable for refrigeration systems, check the four flare connections for leaks.

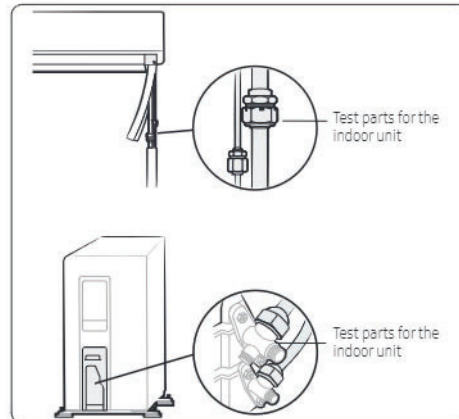

- 7 Wait 10 minutes to make sure that the pressure does not drop.
- 8 Increase the pressure to 400 psig and repeat steps 6 and 7.
- 9 Increase the pressure to 600 psig and repeat steps 6 and 7.
- 10 A drop in pressure during steps 7 through 9 indicates a system leak in the refrigeration line set or indoor unit. Perform a thorough leak check, repair the leak(s), and then repeat this procedure.
- 11 Close the gauge manifold, shut off the nitrogen tank, and remove the common hose to the pressure regulator.
- 12 Vent the nitrogen in lines to the atmosphere to prepare for system evacuation.

Step 4-3 Evacuating the system

CAUTION

- Because the system does not have filter driers, you must perform this triple evacuation procedure to remove all noncondensables and moisture from the system before charging. Failure to do so will result in reduced performance and shorter equipment life.

The time required to perform each evacuation will depend on the capacity (CFM) of the vacuum pump used.

- Install a micron vacuum gauge to the larger liquid/vapor line's service port on the branch of a tee.
- Install the red high-side hose of an R-410A gauge manifold set to the smaller liquid/vapor line's service port on the run of the tee.
- Attach a vacuum pump to the common hose of the manifold set.
- To ensure optimal performance, verify that the vacuum pump's oil has been changed recently.
- With the service port closed and the manifold gauge open, start the vacuum pump and make sure that the vacuum level drops below 4000 microns (as read on the micron gauge). If it is difficult to achieve a proper vacuum, a leak in the hoses is likely. Repair the leak(s) and/or check performance of vacuum pump, then repeat this step.
- Open the service port to connect the system to the manifold.
- Evacuate until 4000 microns is achieved, for at least 10 minutes.
- Close the gauge manifold valve, shut off the vacuum pump, and remove the common hose.
- Connect the hose to the nitrogen pressure regulator and bleed the hose by opening the end of the common hose closest to the manifold.
- Open the high-pressure manifold valve and slowly bring the system pressure to atmosphere (0 psig).
- Close the manifold and nitrogen cylinder and remove the common hose.

- Reconnect the common hose to the vacuum pump. Repeat steps 6 through 12, alternating between breaking the vacuum with dry nitrogen and evacuating, until system evacuation has occurred three times, to the following vacuum levels:

Evacuation	Microns
First	4000
Second	2000
Third	500

- After evacuating to at least 500 microns for the third time, close the gauge manifold valve and wait 10 minutes, making sure that the vacuum level in the system does not decrease. If it does, a small leak is likely. Repair the leak and repeat the evacuation process.

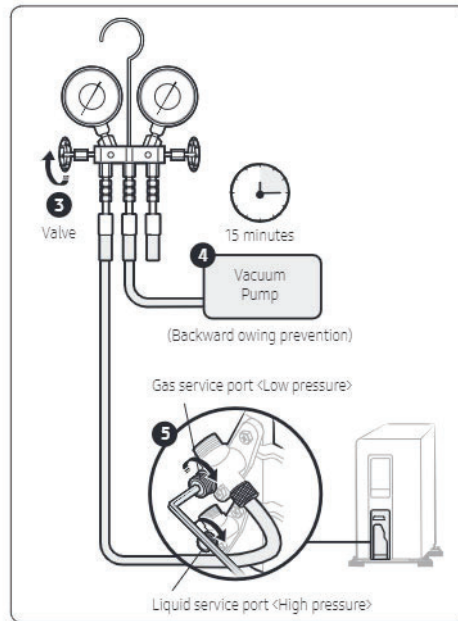

Installation Inspection and Testing

Step 4-4 Adding refrigerant (if needed)

The outdoor unit is charged with sufficient R-410A refrigerant to support up to a 24.6-ft line set. For lengths greater than 24.6 ft, you must add 0.16 oz of refrigerant per foot of additional length, after the lines are evacuated.



- 1 Calculate the additional refrigerant required:
Additional ounces of R-410A = (Total line set feet -24.6) × 0.16
- 2 Connect the common hose of the manifold gauge set to the inverted R-410A refrigerant cylinder.
- 3 Place the refrigerant cylinder on a scale set to measure ounces.
- 4 Open the valve on the tank.
- 5 At the manifold connection, bleed the refrigerant to remove any air that may be present in the common hose.
- 6 Open the gauge manifold and charge the system with the amount of refrigerant calculated in step 1.
- 7 Close the gauge manifold valve, close the valve on the refrigerant tank, and remove the common hose.



Step 4-5 Preparing the system for commissioning

- 1 Wrap the remaining refrigerant pipe lengths and connection points with foam insulation.
- 2 Wrap the unwrapped portions of the piping bundle with vinyl tape.
- 3 With the manifold gauge set still installed, open the isolation valves on the outdoor unit to connect the outdoor unit to the line set and indoor unit.
- 4 Remove the manifold set and vacuum gage.









Step 4-6 Commissioning the unit

The unit is commissioned using the Smart Install feature. Smart Install can be started only with the remote control. While Smart Install is running, you cannot operate the remote control.

- 1 Make sure that the air conditioner is in standby status (powered up with the controller in off mode).
- 2 Install batteries in the remote control.
- 3 Hold down the  (Power),  (Mode), and  (SET) buttons on the remote control simultaneously for 4 seconds.
- 4 Wait until Smart Install succeeds or fails (approximately 7 to 13 minutes).
 - While Smart Install is running:

Type	 Display
Indoor unit indicator	
	The progress is displayed as a number between 0 and 99 on the indoor unit display.

- When Smart Install succeeds: Smart Install ends with a ringing sound, and the air conditioner returns to standby status.
- When Smart Install fails: An error message is displayed on the indoor unit display, and Smart Install ends. To correct the problem, see the error table on page 25.



Error indicator	Error	Measures for the installer to take
 Display		
	Communication error between indoor and outdoor units	<ul style="list-style-type: none"> Check the cables between the indoor and outdoor units. See if the power cable or communication cable is crossed.
	Error on indoor temperature sensor	<ul style="list-style-type: none"> Make sure that the indoor temperature sensor is properly connected.
	Error on indoor heat exchanger	<ul style="list-style-type: none"> Make sure that the evaporator temperature sensor is properly connected.
	Error on indoor fan motor	<ul style="list-style-type: none"> Make sure that the evaporator motor is properly connected to the board. Check for a foreign substance inside the unit that may be preventing the blower wheel from turning.
	EEPROM/Option error	<ul style="list-style-type: none"> Reset the option codes.
	Refrigerant flow blocking error	<ul style="list-style-type: none"> Make sure that the service valves are completely open. Check for any blockage in the refrigerant pipe that connects the indoor and outdoor units. Check for refrigerant leaks.
	Lack of refrigerant (for inverter models only)	<ul style="list-style-type: none"> Make sure a sufficient amount of refrigerant has been added for a pipe that is longer than 24.60ft (7.5 m). Check for refrigerant leaks between the valve and pipe connection.

Step 4-7 Performing final checks and trial operation



WARNING

Stop the unit, disconnect the power, and contact Samsung technical support if any of the following occurs:

- The unit produces a burning smell or smoke.
- The power cable is hot or damaged.
- The unit is very noisy.
- Any foreign substance, such as water, has entered the appliance.
- The appliance becomes flooded.

- Check the following:
 - Strength of the installation site
 - Tightness of pipe connection to detect gas leak
 - Electric wiring connection
 - Heat-resistant insulation of the pipe
 - Drainage
 - Grounding conductor connection
 - Correct operation (Take the following steps.)
- Press the  (Power) button on the remote control to check the following:
 - The indicator on the indoor unit lights up.
 - The airflow blade opens and the fan gears up for operation.
- Press the  (Mode) button to select Cool or Heat mode. Then take the following sub-steps:
 - In Cool mode, use the Temperature button to set the set temperature to 61 °F (16 °C)



Installation Inspection and Testing

- In Heat mode, use the Temperature button to set the set temperature to 86 °F (30 °C)
 - Check whether, approximately 3 to 5 minutes later, the outdoor unit starts, and a cool or warm air blows out.
 - After 12 minutes of stationary condition, check the indoor unit air treatment.
- 4 Press the  (Air swing) button to check whether the airflow blades work properly.
 - 5 Press the  (Power) button to stop the trial operation.

Pumping down for removing the product

Pump-down is an operation intended to collect all the system refrigerant in the outdoor unit. This operation must be carried out before disconnecting the refrigerant tubing in order to avoid refrigerant loss to the atmosphere.

WARNING

- After installing the product, be sure to perform leak tests on the piping connections. After pumping down refrigerant to inspect or relocate the outdoor unit, be sure to stop the compressor and then remove the connected pipes.
 - Do not operate the compressor while a valve is open due to refrigerant leakage from a pipe or an unconnected or incorrectly connected pipe. Failure to do so may cause air to flow into the compressor and too a high pressure to develop inside the refrigerant circuit, leading to an explosion or product malfunction.
- 1 Hold down the  (Power) button on the indoor unit for 5 seconds. Beep sounds immediately to indicate that the product is ready for pump down procedure.
 - 2 Let the compressor run for more than 5 minutes.
 - 3 Release the valve caps on High and Low pressure side.
 - 4 Use L-wrench to close the valve on the high pressure side.
 - 5 After approximately 1 minute, close the valve on the low pressure side.
 - 6 Stop operation of the air conditioner by pressing the  (Power) button on the indoor unit or remote control.
 - 7 Disconnect the pipes.

CAUTION

- Compressor damage may occur if the compressor is run at a negative suction pressure.

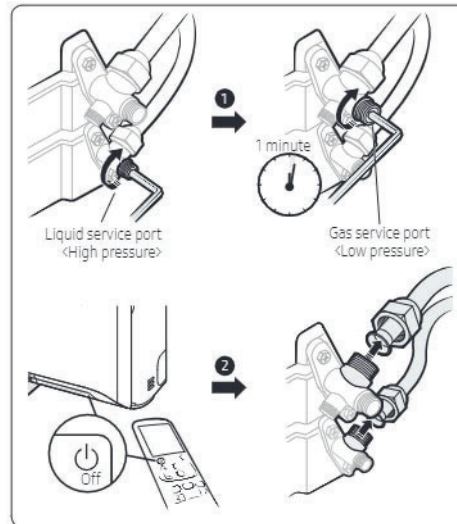

Setting the installation options

Setting the installation options

This product has the installation options depending on the user's installation environment. Even after the product ships, it is possible to input option changes to the indoor unit using the transmission packet of the remote control.

This chapter provides a method for setting the installation options.

STEP1. Common steps for setting the options



NOTE

- The remote control display and buttons may vary depending on the model.

- Enter the mode for setting the options:
 - Remove the batteries from the remote control, and then insert them again.
 - While holding down the (High Temp) and (Low Temp) buttons simultaneously, insert the batteries into the remote control.
 - Make sure that you are entered to the mode for setting the options:
- Set the option values

CAUTION

- The total number of available options are 24: SEG1 to SEG24.
- Because SEG1, SEG7, SEG13, and SEG19 are the page options used by the previous remote control models, the modes to set values for these options are skipped automatically.
- Set a 2-digit value for each option pair in the following order: SEG2 and SEG3 → SEG4 and SEG5 → SEG6 and SEG8 → SEG9 and SEG10 → SEG11 and SEG12 → SEG14 and SEG15 → SEG16 and SEG17 → SEG18 and SEG20 → SEG21 and SEG22 → SEG23 and SEG24



























SEG1	SEG2	SEG3	SEG4	SEG5	SEG6
0	X	X	X	X	X
SEG7	SEG8	SEG9	SEG10	SEG11	SEG12
1	X	X	X	X	X
SEG13	SEG14	SEG15	SEG16	SEG17	SEG18
2	X	X	X	X	X
SEG19	SEG20	SEG21	SEG22	SEG23	SEG24
3	X	X	X	X	X

On (SEG1 to SEG12)	Off (SEG13 to SEG24)

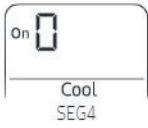
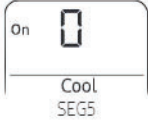



















Installation

Setting the installation options

Take the steps presented in the following table:



















Steps	Remote control display
<p>1 Set the SEG2 and SEG3 values:</p> <p>a Set the SEG2 value by pressing the  (Wind Free) button repeatedly until the value you want to set appears on the remote control display.</p> <p>b Set the SEG3 value by pressing the  (Fast) button repeatedly until the value you want to set appears on the remote control display.</p> <p>When you press the  (Wind Free) or  (Fast) button, values appear in the following order:  →  → ... →  → </p>	 
<p>2 Press the  (Mode) button. Cool and On appear on the remote control display.</p>	
<p>3 Set the SEG4 and SEG5 values:</p> <p>a Set the SEG4 value by pressing the  (Wind Free) button repeatedly until the value you want to set appears on the remote control display.</p> <p>b Set the SEG5 value by pressing the  (Fast) button repeatedly until the value you want to set appears on the remote control display.</p> <p>When you press the  (Wind Free) or  (Fast) button, values appear in the following order:  →  → ... →  → </p>	 
<p>4 Press the  (Mode) button. Dry and On appear on the remote control display.</p>	
<p>5 Set the SEG6 and SEG8 values:</p> <p>a Set the SEG6 value by pressing the  (Wind Free) button repeatedly until the value you want to set appears on the remote control display.</p> <p>b Set the SEG8 value by pressing the  (Fast) button repeatedly until the value you want to set appears on the remote control display.</p>	 



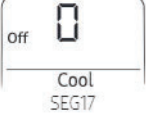













Installation

Steps	Remote control display
<p>When you press the  (Wind Free) or  (Fast) button, values appear in the following order: 0 → 1 → ... → E → F</p>	
<p>6 Press the  (Mode) button. Fan and On appear on the remote control display.</p>	
<p>7 Set the SEG9 and SEG10 values:</p> <p>a Set the SEG9 value by pressing the  (Wind Free) button repeatedly until the value you want to set appears on the remote control display.</p> <p>b Set the SEG10 value by pressing the  (Fast) button repeatedly until the value you want to set appears on the remote control display.</p> <p>When you press the  (Wind Free) or  (Fast) button, values appear in the following order: 0 → 1 → ... → E → F</p>	 
<p>8 Press the  (Mode) button. Heat and On appear on the remote control display.</p>	
<p>9 Set the SEG11 and SEG12 values:</p> <p>a Set the SEG11 value by pressing the  (Wind Free) button repeatedly until the value you want to set appears on the remote control display.</p> <p>b Set the SEG12 value by pressing the  (Fast) button repeatedly until the value you want to set appears on the remote control display.</p> <p>When you press the  (Wind Free) or  (Fast) button, values appear in the following order: 0 → 1 → ... → E → F</p>	 
<p>10 Press the  (Mode) button. Auto and Off appear on the remote control display.</p>	

Setting the installation options

Installation

Steps	Remote control display
<p>11 Set the SEG14 and SEG15 values:</p> <p>a Set the SEG14 value by pressing the  (Wind Free) button repeatedly until the value you want to set appears on the remote control display.</p> <p>b Set the SEG15 value by pressing the  (Fast) button repeatedly until the value you want to set appears on the remote control display.</p> <p>When you press the  (Wind Free) or  (Fast) button, values appear in the following order: 0 → 1 → ... → E → F</p>	 
<p>12 Press the  (Mode) button. Cool and Off appear on the remote control display.</p>	
<p>13 Set the SEG16 and SEG17 values:</p> <p>a Set the SEG16 value by pressing the  (Wind Free) button repeatedly until the value you want to set appears on the remote control display.</p> <p>b Set the SEG17 value by pressing the  (Fast) button repeatedly until the value you want to set appears on the remote control display.</p> <p>When you press the  (Wind Free) or  (Fast) button, values appear in the following order: 0 → 1 → ... → E → F</p>	 
<p>14 Press the  (Mode) button. Dry and Off appear on the remote control display.</p>	
<p>15 Set the SEG18 and SEG20 values:</p> <p>a Set the SEG18 value by pressing the  (Wind Free) button repeatedly until the value you want to set appears on the remote control display.</p> <p>b Set the SEG20 value by pressing the  (Fast) button repeatedly until the value you want to set appears on the remote control display.</p>	 

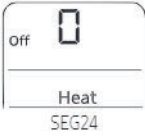

Steps	Remote control display
<p>When you press the  (Wind Free) or  (Fast) button, values appear in the following order: 0 → 1 → ... → E → F</p>	<p>SEG20</p>
<p>16 Press the  (Mode) button. Fan and Off appear on the remote control display.</p>	
<p>17 Set the SEG21 and SEG22 values:</p> <ul style="list-style-type: none"> a Set the SEG21 value by pressing the  (Wind Free) button repeatedly until the value you want to set appears on the remote control display. b Set the SEG22 value by pressing the  (Fast) button repeatedly until the value you want to set appears on the remote control display. <p>When you press the  (Wind Free) or  (Fast) button, values appear in the following order: 0 → 1 → ... → E → F</p>	 
<p>18 Press the  (Mode) button. Heat and Off appear on the remote control display.</p>	
<p>19 Set the SEG23 and SEG24 values:</p> <ul style="list-style-type: none"> a Set the SEG23 value by pressing the  (Wind Free) button repeatedly until the value you want to set appears on the remote control display. b Set the SEG24 value by pressing the  (Fast) button repeatedly until the value you want to set appears on the remote control display. <p>When you press the  (Wind Free) or  (Fast) button, values appear in the following order: 0 → 1 → ... → E → F</p>	 

Installation

Setting the installation options

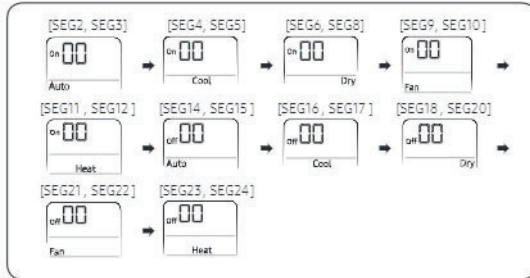
- 3 Check whether the option values that you have set are correct by pressing the  (Mode) button repeatedly



- 4 Save the option values into the indoor unit:
 Point the remote control to the remote control sensor on the indoor unit and then press the  (Power) button on the remote control twice. Make sure that this command is received by the indoor unit. When it is successfully received, you can hear a short sound from the indoor unit. If the command is not received, press the  (Power) button again.

Installation

STEP 2. Setting the installation options in a batch

Installation option no. for an indoor unit : 02XXXX-1XXXXX-2XXXXX-3XXXXX

The installation option can be set at the factory differently depending on the function of each model.

Various option items of each address assigned within the installation option are shown in the following table.

- Among the values expressed in each address, "Reserved" cannot be changed because it means no options are allocated or a unique function for the model is already assigned. The options SEG4, SEG5, SEG8, SEG14, SEG15, SEG17, SEG18, and SEG20 can be changed to reflect the present installation conditions, if needed.
 - Before changing the options, make sure that the power is supplied to the indoor unit. If the indoor unit is not plugged in, it must include a power supply so that the remote control's option transmission packet can be input to the indoor unit.
 - When changing the options according to the installation environment, there are two methods: changing 24 digits in a batch and changing the options individually.
 - To change in a batch, you must first know the entire 24-digit installation options of the model from the service manual. Set the installation options of indoor units by following the steps in STEP 1. Common steps for setting the options on page 27 after determining the specific address segment values required to change the installation options.
 - If you do not know the entire installation options, refer to the following section STEP 3. Changing the options individually on page 35.
 - Description of option segments with changeable values

① SEG4 : set for using "Indoor external temperature sensor" or "fan Thermo off control"
(Fan thermo off control only: 1, external sensor only: 6, using both: 7)

CAUTION

- "Fan Thermo Off control" is only available for an indoor unit for Free Joint Multi.
When "Fan Thermo Off control" is matched with a Single Zone High-Wall system, the setting cannot be made using this option. But you can set this option by referring to the following section STEP 3. Changing the options individually on page 35.

② SEG5 : To use the central controller, enter 1.

③ SEG8 : To use the external drain pump, enter 8.

NOTE

- If the SEG8 is set to 'Use', the SEG14-External Contact Control will be set to DISABLE automatically.
- ④ SEG14 : As an External Contact Control option, check the installation site and then select the appropriate option.

NOTE

- If SEG14 is not set to 'default', SEG8-the external drain pump will not to be available.
- ⑤ SEG15 : Set an output option according to external control (Thermo on - 0, Operation on - 1)
- ⑥ SEG17 : Control the received sound tone of the remote control of the indoor unit. (Buzzer use - 0, disuse - 1)
- ⑦ SEG18 : Change the filter usage time of the indoor unit (500HR - 1, 1000HR - 2)
- ⑧ SEG20 : Set this option to control an indoor unit using a specific remote control.

Setting the installation options

Option	SEG1		SEG2			SEG3			SEG4			SEG5			SEG6		
Function	Page		Mode			Reserved			Use of external room temperature sensor/ Fan Thermo Off control			Use of central control			Reserved		
Indication and details	Indication	Details	Indication	Details	Factory set				Indication	Details	Factory set	Indication	Details	Factory set			
		0		2	Installation	-	0	Disuse	0	0	Disuse	1	1	Use			
							1	Use/Disuse									
							6	Disuse/Use									
						7	Use/Use										
Option	SEG7		SEG8			SEG9			SEG10			SEG11			SEG12		
Function	Page		Use of drain pump			Reserved			Reserved			Reserved			Reserved		
Indication and details	Indication	Details	Indication	Details	Factory set												
		1		0	Disuse	0											
			8	Use external drain pump													
Option	SEG13		SEG14			SEG15			SEG16			SEG17			SEG18		
Function	Page		Use of external control			Setting the output of external control			Reserved			Buzzer control (Receiving tone of indoor unit)			Use Time of Filter		
Indication and details	Indication	Details	Indication	Details	Factory set	Indication	Details	Factory set				Indication	Details	Factory set	Indication	Details	Factory set
		2	0	Disuse	0	0	Thermo on	0	0	Use	0	0	Disuse	1			
			1	On/Off control		1	Operation on		1	Disuse		1	500HR				
			2	Off control		-	-		-	-		2	1000HR				
			3	Window On/Off control		-	-		-	-		-	-				
			8	Reverse control		-	-		-	-		-	-				
			9	On/Off & Reverse control		-	-		-	-		-	-				
			A	Off & Reverse control		-	-		-	-		-	-				
			B	Window on/Off & Reverse control		-	-		-	-		-	-				
Option	SEG19		SEG20			SEG21			SEG22			SEG23			SEG24		
Function	Page		Wireless controller address			Reserved			Reserved			Reserved			Reserved		
Indication and details	Indication	Details	Indication	Details	Factory set												
		3	0 or 1	Indoor1	0												
			2	Indoor2													
			3	Indoor3													
	4		Indoor4														

Installation

STEP 3. Changing the options individually

When you want to change the value of a specific option, refer to the following table and follow the steps in STEP1. Common steps for setting the options on page 27.

(Enter the set address of the installation option to change in SEG4 and SEG5 in the table below, enter the change option value in SEG6. The values of SEG1, SEG2, SEG3, and SEG4 are always 0, D, 2 in the same order as in the following table.)

Option	SEG1		SEG2		SEG3		SEG4		SEG5		SEG6	
Function	Page		Mode		Option mode to change		Tens position of the option number		Units position of the option number		New value	
Indication and details	Indication	Details	Indication	Details	Indication	Details	Indication	Details	Indication	Details	Indication	Details
		0		D		2		Tens position value	0 to 9	Units position value	0 to 9	New value

Example: Changing the Buzzer control (SEG17) option of the installation options to 1 (disuse).

Option	SEG1		SEG2		SEG3		SEG4		SEG5		SEG6	
Function	Page		Mode		Option mode to change		Tens position of the option number		Units position of the option number		New value	
Indication	0		D		2		1		7		1	

NOTE

- How to set the thermo off option for a Single Zone High-Wall system is shown in the following option table:

Option	SEG1		SEG2		SEG3		SEG4		SEG5		SEG6	
Function	Page		Mode		Option mode to change		Tens position of the option number		Units position of the option number		New value	
Indication	0		D		1		2		4		F	

Sub PCB installation(optional)

(Wired remote controller, central remote controller etc.)

- 1 Turn the power off and take off the cover panel of the indoor unit.

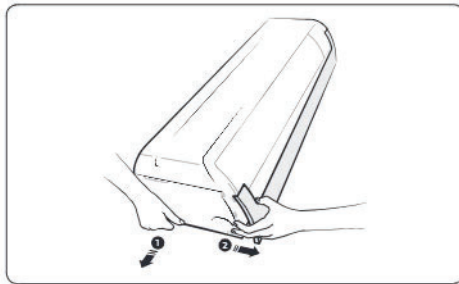

- 2 Attach the Sub PCB to the Case Sub PCB.
- 3 Assemble the Case Sub PCB to the indoor unit.

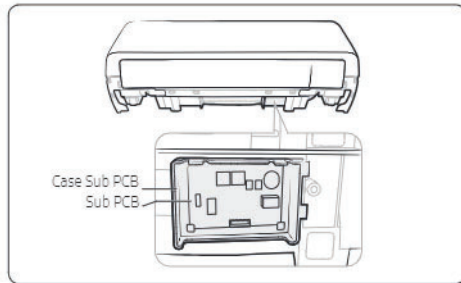

- 4 Find the PCB wire, and connect the wire to the Sub PCB as seen in the picture.

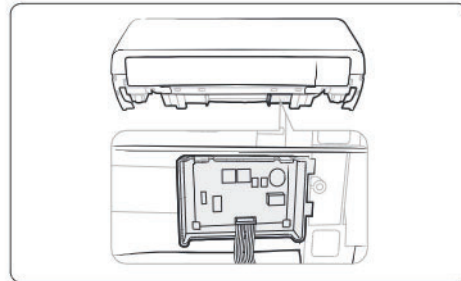

- 5 Connect the wire(remote controller, central remote controller etc) to the Sub PCB.
- 6 Assemble the Cover PCB and the front panel.
※ If the Sub PCB is not installed, arrange the wire for multi system (connection) as shown in the illustration.

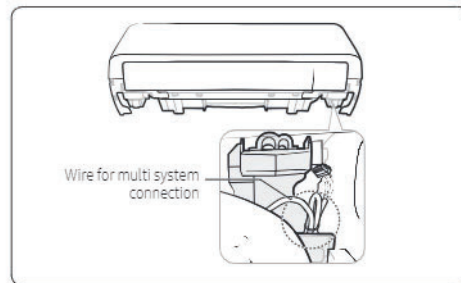

NOTE

- The Sub PCB is attached to be controlled by the wired remote controller and central controller.

SAMSUNG

SAMSUNG

SPLIT-TYPE AIR CONDITIONER

	INDOOR UNIT	OUTDOOR UNIT
MODEL CODE	AR07BSFCMWKNCV	-
	AR09BSFCMWKNCV	AR09BSFCMWKXCV
	AR12BSFCMWKNCV	AR12BSFCMWKXCV
	AR15BSFCMWKNCV	-
	AR18BSFCMWKNCV	AR18BSFCMWKXCV
	AR24BSFCMWKNCV	AR24BSFCMWKXCV
	AR15BSFACWKNCV	AR15BSFACWKXCV

SERVICE *Manual*

AIR CONDITIONER

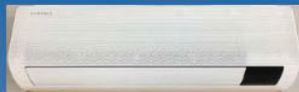

AR07BSFCMWKNCV
AR09BSFCMWKNCV
AR12BSFCMWKNCV
AR15BSFCMWKNCV
AR18BSFCMWKNCV
AR24BSFCMWKNCV
AR15BSFACWKNCV



AR09BSFCMWKXCV
AR12BSFCMWKXCV



AR18BSFCMWKXCV



AR24BSFCMWKXCV
AR15BSFACWKXCV

CONTENTS

1. Precautions
2. Product Specifications
3. Alignment and Adjustments
4. Disassembly and Reassembly
5. ASSY CONTROL
6. Wiring Diagram
7. PCB Diagram
8. Operating Instructions
9. Troubleshooting
10. Block Diagram
11. Reference Sheet

Contents

1. Precautions	4
1-1 Installing the air conditioner	4
1-2 Power supply and circuit breaker	4
1-3 During operation	4
1-4 Disposing of the unit	5
1-4 Others	5
2. Product Specifications	6
2-1 The Feature of Product	6
2-2 Product Specifications	7
2-3 The comparative specifications of product	9
2-4 Accessory and option specifications	10
3. Alignment and Adjustments	11
3-1 Test mode	11
3-2 Display Error and Check Method	12
3-3 Setting Option Setup Method	14
4. Disassembly and Reassembly	18
4-1 Indoor Unit	18
4-2 Outdoor Unit	29
5. ASSY CONTROL	42
5-1 ASSY KIT CODE DB92-04845U	42
5-2 ASSY KIT CODE DB92-04842N	43
5-3 ASSY KIT CODE DB92-04849D	44
5-4 ASSY KIT CODE DB92-04843H	45
6. Wiring Diagram	46
6-1 Indoor unit	46
6-2 Outdoor unit	47
7. PCB Diagram	48
7-1 Indoor Main PCB CODE DB92-04839A	48
7-2 Outdoor Main PCB CODE DB92-04837D	49
7-3 Outdoor PCB Inverter CODE DB92-04838A	51
7-4 DISPLAY PCB	52
7-5 Wire connecting the indoor unit terminal blocks	54

Contents

8. Operating Instructions	55
8-1 Name of Each Part	55
8-2 Wireless Remote Control-Buttons and Display	57
9. Troubleshootin	58
9-1 Items to be checked First	58
9-2 Communication Error	59
9-2-1 Communication Error	59
9-2-2 Indoor temperature sensor Error	60
9-2-3 Indoor fan motor speed detecting error (BLDC fan)	61
9-2-4 Outdoor temperature sensor error	62
9-2-5 Outdoor Cond temperature sensor error	63
9-2-6 Outdoor Discharge temperature sensor error	64
9-2-7 Operation condition secession error	65
9-2-8 EEPROM error/OTP error	66
9-2-9 Outdoor Fan motor error	67
9-2-10 Compressor starting error	68
9-2-11 Compressor wire missing error/rotation error	69
9-2-12 Current sensor error/Input current sensor error	70
9-2-13 O.C(Over Current) error	71
9-2-14 No power outdoor (Initial Diagnosis) (Not displayed)	73
9-2-15 When the Up/Down, Left/Right, Grill louver motor does not operate	74
9-2-16 When the remote control is not receiving	75
9-2-17 Smart Install error	76
9-2-18 Outdoor OLP over temperature error (One way Inverter Only)	77
9-2-19 EEV or VALVE CLOSE error (C422)	78
10. Block Diagram	79
10-1 Indoor unit	79
10-2 Outdoor unit	80
11. Reference Sheet	83
11-1 Low Refrigerant Pressure Distribution	83
11-2 Pressure & Capacity mark	83
11-3 Q & A for Non-trouble	84
11-4 Cleaning /Filter Change	85
11-5 Installation	90
11-6 Installation Diagram of Indoor Unit and Outdoor Unit	91
11-7 Reference sheet	93

1. Precautions

1-1 Installing the air conditioner

- Users should not install the air conditioner by themselves. Ask the dealer or authorized company to install the air conditioner except window-type air conditioner in U.S.A and Canada.
- If you don't install the air conditioner properly, it may cause a fire, a water leakage or an electric shock.
- You must install the air conditioner according to the national wiring regulations and safety regulations.
- Install the indoor unit higher than 2.5m from the floor to avoid the injury caused by the operation of the fan. (except the window-type air conditioner)
- The manufacturer is not responsible for any accidents or injury caused by an incorrect installation.
- When installing the built-in type air conditioner, keep all electric cables such as the power cable and the connection cord in pipes, ducts, or cable channels to protect them from the danger of impact or any other incidents.

1-2 Power supply and circuit breaker

- If the power cord of the air conditioner is damaged, it must be replaced by the manufacturer or a qualified person in order to avoid a hazard.
- The air conditioner must be plugged into an independent circuit if applicable or connect the power cable to the auxiliary circuit breaker. An all pole disconnection from the power supply must be incorporated in the fixed wiring with a contact opening of >3mm.
- Do not extend an electric cord to the air conditioner.
- The air conditioner must be plugged in after you complete the installation.

1-3 During operation

- Do not repair the air conditioner at your discretion. It is recommended to contact a service center directly.
- Never spill any kind of liquid on the air conditioner. If this happens, turn off the air conditioner and contact an authorized service center.
- Do not insert anything between the airflow blades to prevent damage of the inner fan and consequent injury. Keep children away from the air conditioner.
- Do not place any obstacles in front of the air conditioner.
- Do not spray any kind of liquid into the indoor unit. If this happens, turn off the air conditioner and contact a service center.
- Make sure that the air conditioner is well ventilated at all times. Do not place a cloth or other materials over it.
- Remove the batteries if you don't use the remote control for a long time. (If applicable)
- Use the remote control within 7 meters from the indoor unit. (If applicable)

1-4 Disposing of the unit

- Before the throwing out the air conditioner, remove the batteries from the remote control.
- When you dispose of the air conditioner, consult your dealer. If pipes are removed incorrectly, refrigerant may blow out and cause air pollution. When it contacts with your skin, it can cause skin injury.
- The package of the air conditioner should be recycled or disposed of properly for environmental reasons.

1-5 Others

- Never store or load the air conditioner upside down or sideways to prevent the damage to the compressor.
- Young children or infirm persons should be always supervised when they use the air conditioner.
- Max current is measured according to IEC standard for safety.
- Current is measured according to ISO standard for energy efficiency.

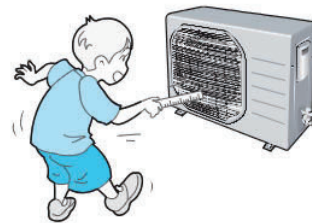

2. Product Specifications

2-1 The Feature of Product

- ◆ **Fast cooling**

If you want the strong and cool air, just select Fast function! It will get you the strongest air!

- ◆ **WindFree Cooling**

Use the WindFree Cooling function to enjoy a mild breeze coming through fine holes in the WindFree panel instead of air coming directly through the air flow blades.

- ◆ **Eco**

Use the Single User function when you're along at home. Aside from energy savings from the inverter technology, the Single User Mode will further minimize your energy consumption and reduce your electricity bill by adjusting the maximum operating capacity of the compressor.

- ◆ **Easy Filter**

There is no grille to remove before separating the filter from the air conditioner! Therefore, filter can be cleaned easily and more frequently. Constant filter cleaning will prevent dust from entering the product or accumulating on the filter.

- ◆ **good'sleep function**

good'sleep function will allow you to have deep, good night's sleep by adjusting the temperature, fan speed and air flow direction.

- ◆ **Smart Install**

When the installation is done, your product will examine itself through trial operation to check if it was installed properly.

- ◆ **Easy Installation**

It's so easy to install! You can easily hang the product on the wall and connect the pipes and wires by opening the cover on the bottom of the product. Now you won't have to tilt the product to connect the pipe and the wires!

2-2 Product specification

Model			AR09BSFCMWK/CV	AR12BSFCMWK/CV	AR18BSFCMWK/CV	AR24BSFCMWK/CV
Rating	Mode	Unit	Wall-mounted	Wall-mounted	Wall-mounted	Wall-mounted
Capacity	T1 Cool	Btu/h	9000	12000	18000	22000
	T3 Cool	Btu/h	-	-	-	-
	Heat	Btu/h	11000	12000	21000	24000
Power Input	T1 Cool	W	645	995	1630	2100
	T3 Cool	W	-	-	-	-
	Heat	W	865	960	1850	2290
Current	T1 Cool	A	3.1	4.8	7.4	9.8
	T3 Cool	A	-	-	-	-
	Heat	-	4.2	4.6	8.2	10.5
Efficiency	EER	Btu/hW	13.95	12.05	11.05	10.50
	-	-	-	-	-	-
	COP	W/W	12.70	12.50	11.35	10.50
Dehumidifying		L/hr.	2.5	2.5	2.5	2.5
Platform	IDU	-	QF1	QF1	QF3	QF3
	ODU	-	N-SI	N-SI	Q-480	P-520
Evap	Main	-	Φ7, 2R*9(10)S*591mm, H1.3, N.G.S, 1by2	Φ7, 2R*9(10)S*591mm, H1.3, N.G.S, 1by2	Φ7, 2R*10S*825.5mm, H1.3, N.G.S, 4by4	Φ7, 2R*10S*825.5mm, H1.3, N.G.S, 4by4
	Sub	-	Φ7, 2R*5(6)S*591mm, H1.3, N.G.S : (S1-5)	Φ7, 2R*5(6)S*591mm, H1.3, N.G.S : (S1-5)	Φ7, 2R*5(6)S*826mm, H1.3, N.G.S : (S3-3)	Φ7, 2R*5(6)S*825.5mm, H1.3, N.G.S : (S3-4)
Cond	Main	-	Φ7W, 2R*24S*850/825mm, Corrugate1.5, N.G.S, 4by4by2	Φ7W, 2R*24S*850/825mm, Corrugate1.5, N.G.S, 4by4by2	Φ7W, 2R*28S*906.8mm, Corrugate1.5, N.G.S, 4by4by1	Φ7W, 2R*36S*906.8mm, Corrugate1.5, N.G.S, 5by5by1
	Sub	-	-	-	-	-
Comp	Model	-	KTN130D42UFR	KTN130D42UFR	UG9TK3150FE4	UG8TH8265FEW
	OLP	-	-	-	-	-
Motor In	Code	-	DB31-00694A	DB31-00694A	DB31-00636A	DB31-00636A
	Name	-	-	-	-	-
Motor Out	Code	-	DB31-00642C	DB31-00642C	DB31-00642C	DB31-00579A
	Name	-	-	-	-	-
Expansion	Φ * L	-	Φ1.4	Φ1.4	Φ1.65	Φ1.65
Refrigerant	type	-	R410A	R410A	R410A	R410A
	charge	g	1000 g	1000 g	1300 g	1800 g
SVC Valve	Liquid / Gas	-	Φ6.35/Φ9.52	Φ6.35/Φ9.52	Φ6.35/Φ12.7	Φ6.35/Φ15.88
Tube	Dis. / Suc.	-	Φ9.52/Φ12.7	Φ9.52/Φ12.7	Φ9.52/Φ12.7	Φ9.52/Φ15.88
Drain hose	D * L	mm	20*550	20*550	20*550	20*550
4-WAY V/V		-	-	-	-	-
Power Supply		V/Hz/Φ	208-230/60/1	208-230/60/1	208-230/60/1	208-230/60/1
Climate Class		-	T1	T1	T1	T1
Noise	IDU UT,T	dB	41 dB↓	43 dB↓	48 dB↓	51 dB↓
	ODU	dB	51 dB↓	53 dB↓	57 dB↓	60 dB↓
Net Size (W*D*H)	IDU	mm	820*299*215	820*299*215	1055*299*215	1055*299*215
	ODU	mm	790*548*285	790*548*285	880*638*310	880*798*310
Weight	IDU	kg	10.1	10.1	11.5	11.5
	ODU	kg	32.4	32.4	38.1	55.6
Operation range	Cooling	IDU	61 ~ 90 °F	61 ~ 90 °F	61 ~ 90 °F	61 ~ 90 °F
		ODU	-0.4 ~ 115 °F	-0.4 ~ 115 °F	-0.4 ~ 115 °F	-0.4 ~ 115 °F
	Heating	IDU	81 °F or less	81 °F or less	81 °F or less	81 °F or less
		ODU	-13 ~ 75 °F	-13 ~ 75 °F	-13 ~ 75 °F	-13 ~ 75 °F

2-2 Product specification







Model			AR07BSFCMWKNCV	AR15BSFCMWKNCV	AR15BSFACWK/CV
Rating	Mode	Unit	Wall-mounted	Wall-mounted	Wall-mounted
Capacity	T1 Cool	Btu/h	7,000	12000	15000
	T3 Cool	Btu/h	-	-	-
	Heat	Btu/h	7,500	12000	16500
Power Input	T1 Cool	W	30	995	1070
	T3 Cool	W	-	-	-
	Heat	W	30	960	1320
Current	T1 Cool	A	0.3	4.8	5
	T3 Cool	A	-	-	-
	Heat	A	0.3	4.6	6
Efficiency	EER	Btu/hW	-	-	14.00
	-	-	-	-	-
	COP	W/W	-	-	12.50
Dehumidifying		L/hr.	-	-	2.5
Platform	IDU	-	QF1	QF1	QF3
	ODU	-	-	-	P-520
Evap	Main	-	Φ7, 2R*9(10)S*591mm, F.P1.3, H-fin, N.G.S 1by2	Φ7, (2R*10S+1R*4S)*660mm, F.P1.3, H-fin, N.G.S, 1by2	Φ7, (2R*10S+1R*4S)*825.5mm, (H1.3+H1.3), Hydrophilic, 4by4
	Sub	-	Φ7, 2R*5(6)S*591mm, H1.3, N.G.S : (S1-5)	Φ7, 2R*5(6)S*591mm, H1.3, N.G.S : (S1-5)	Φ7, (2R*6S+1R*4S)*825.5mm, (H1.3+H1.3), Hydrophilic : (S3-6)
Cond	Main	-	-	-	Φ7W, 2R*36S*906.8mm, Corrugate1.5, N.G.S, 5by5by1
	Sub	-	-	-	-
Comp	Model	-	-	-	KTN150D42UFR
	OLP	-	-	-	-
Motor In	Code	-	DB31-00694A	DB31-00636A	DB31-00637A
	Name	-	-	-	-
Motor Out	Code	-	-	-	DB31-00579A
	Name	-	-	-	-
Expansion	Φ * L	-	-	-	Φ1.65
Refrigerant	type	-	R410A	R410A	R410A
	charge	g	-	-	1600 g
SVC Valve	Liquid / Gas	-	-	-	Φ6.35/Φ12.7
Tube	Dis. / Suc.	-	-	-	Φ9.52/Φ12.7
Drain hose	D * L	mm	-	-	20*550
4-WAY V/V		-	-	-	-
Power Supply		V/Hz/Φ	208-230/60/1	208-230/60/1	208-230/60/1
Climate Class		-	-	-	T1
Noise	IDU UT,T	dB	41 dB↓	45 dB↓	46 dB↓
	ODU	dB	-	-	57 dB↓
Net Size (W*D*H)	IDU	mm	820*299*215	820*299*215	1055*299*215
	ODU	mm	-	-	880*793*310
Weight	IDU	kg	9.1	10.6	11.5
	ODU	kg	-	-	55.6
Operation range	Cooling	IDU	61 ~ 90 °F	61 ~ 90 °F	61 ~ 90 °F
		ODU	-0.4 ~ 115 °F	-0.4 ~ 115 °F	-0.4 ~ 115 °F
	Heating	IDU	81 °F or less	81 °F or less	81 °F or less
		ODU	-13 ~ 75 °F	-13 ~ 75 °F	-13 ~ 75 °F

2-3 The comparative specification of product

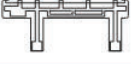
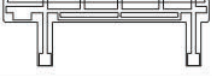
Model		DEVELOPMENT MODEL			
		AR09BSFCMWK/CV	AR12BSFCMWK/CV	AR18BSFCMWK/CV	AR24BSFCMWK/CV
Design	Indoor Unit				
	Outdoor Unit				
Net Weight	Indoor Unit	10.1	10.1	11.5	11.5
	Outdoor Unit	32.4	32.4	38.1	55.6
Net Dimension	Indoor Unit	820*299*215	820*299*215	1055*299*215	1055*299*215
	Outdoor Unit	790*548*285	790*548*285	880*638*310	880*798*310
Noise	Indoor Unit	41 dB↓	43 dB↓	48 dB↓	51 dB↓
	Outdoor Unit	51 dB↓	53 dB↓	57 dB↓	60 dB↓
Air Purifying System		EASY CLEAN FILTER	EASY CLEAN FILTER	EASY CLEAN FILTER	EASY CLEAN FILTER
Indoor Display		88 SEG	88 SEG	88 SEG	88 SEG

Model		DEVELOPMENT MODEL		
		AR07BSFCMWKNCV	AR15BSFCMWKNCV	AR15BSFACWK/CV
Design	Indoor Unit			
	Outdoor Unit	-	-	
Net Weight	Indoor Unit	9.1	10.6	11.5
	Outdoor Unit	-	-	55.6
Net Dimension	Indoor Unit	820*299*215	820*299*215	1055*299*215
	Outdoor Unit	-	-	880*793*310
Noise	Indoor Unit	41 dB↓	45 dB↓	46 dB↓
	Outdoor Unit	-	-	57 dB↓
Air Purifying System		EASY CLEAN FILTER	EASY CLEAN FILTER	EASY CLEAN FILTER
Indoor Display		88 SEG	88 SEG	88 SEG

2-4 Accessory and Option Specifications

Item	Descriptions	Code No.	Q'ty	Remark
	ASSY HANGER	DB90-11453A (Q1, Q2)	1	Indoor unit case
		DB90-11454A (Q3)	1	
	ASSY WIRELESS REMOCON	DB96-24901B	1	
	MANUAL USER	DB68-11414A	1	
	MANUAL INSTALL	DB68-11463A	1	
	Batteries for Remote controller	4301-000121	2	
	Rubber Leg	DB67-01533A	4	Outdoor unit case
	Drain plug	DB67-20011A	1	

3. Alignment and Adjustments

3-1 Test Mode

◆ How to Approach Test Mode

You can approach the test mode by pressing the on/off switch of indoor unit for 5 seconds.

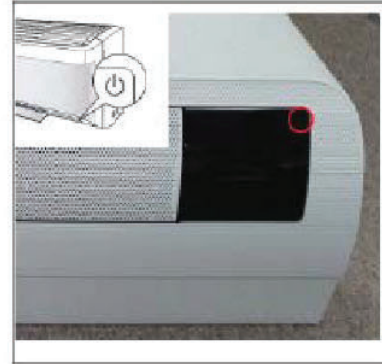

◆ Test mode operation option

After installing the air conditioner, check whether each subordinate is normally operated or not by operating the test mode.

- When an Error occurs, display the Error Mode.
- **Operation Mode** : Cool mode. operate the cool mode by operating the compressor by force without the compressor ON/OFF according to the set temperature/indoor temperature. (Do not follow the antifreeze control)
- **Up-down louver** : Up-down swing mode
- **Indoor Fan** : Turbo



Note

- Because the heat mode operate the cool mode by force not related to the set temperature / indoor temperature, check whether each subordinate is operated normally or not after completing installation and must turn off the power of the air conditioner.

3-2 Display Error and Check Method

3-2-1 Indoor Display Error and Check Method

ERROR MODE	TYPE	DESCRIPTION
7-SEG	INDOOR/ OUTDOOR	
C101, C102	INDOOR	Communication error
C108		Set address error
C121		Room TH sensor error
C122, C123		INDOOR MID, INDOOR IN EVA-TH sensor error
C140		Dust sensor error
C142		Humidity error
C143		Motion sensor error
C154		Fan error(indoor)
C161		Mixed operation error
C163		Option error
C187		K1 filter feed back error
C665		Drain pump error

Note

If the set doesn't work (No power), check the thermal fuse of terminal block OPEN or SHORT with Multimeter.

* Measure the thermal fuse housing PIN#1~2 : OPEN(disconnection)-> defective product

3-2 Display Error and Check Method

3-2-2 Outdoor Display Error and Check Method

7-SEG	ERROR MODE			DESCRIPTION
	YEL	GRN	RED	
-	○	○	○	Power off /VDD NG
-	●	●	●	Power on reset (1sec)
-	○	◐	●	Normal operation
-	○	○	●	Abnormal communication (Indoor <-> Outdoor)
-	○	●	●	
C464	○	○	◐	IPM over current (O.C) error
C461	○	◐	○	Comp. strating error
C470	○	●	○	EEPROM data error (no data)
C466	○	●	◐	DC-Link voltage under / Over error
C484				PFC over load error
C483				Over voltage protection error
C221	◐	○	◐	OUT-TH (Outdoor temperature) sensor error
C416	◐	○	●	DIS-TH (Discharge temperature) Over error
C251	◐	◐	○	DIS-TH (Discharge temperature) sensor error
C468	◐	◐	●	Current sensor error
C474				Heatsink sensor error
C485				Input current sensor error
C465	◐	●	○	Comp. V_limit/ I_limit error
C500				Heatsinkover temperature error
C231	◐	●	◐	CON-TH (Cond temperature) sensor error
C203	◐	●	●	Time out Comp. (Inv Micom <->Main Micom)
C458	●	○	○	Fan error
C471	●	○	◐	EEPROM data error (Main Micom <-> INV Micom)
C467	●	○	●	Comp. wire missing error
C440	●	◐	○	Prohibit operation condition error (Heating)
C441				Prohibit operation condition error (Cooling)
C469	●	◐	◐	DC-Link voltage sensor
C488				AC Input voltage sensor
C462	●	◐	●	AC Input I_limit trip error
C554	●	●	○	Gas leak error
C574				Gas shortage error
C422	◐	○	●	Outdoor OLP over temperature error
-	○	◐	◐	Test operation at Cooling mode
-	◐	◐	◐	Test operation at Heating mode

● : LAMP ON

○ : LAMP OFF

◐ : LAMP BLINK



3-3 Setting Option Setup Method

Ex) Option No. :

11-F4-50-bA-6A-01-E0-07-F7-C4

Step 1









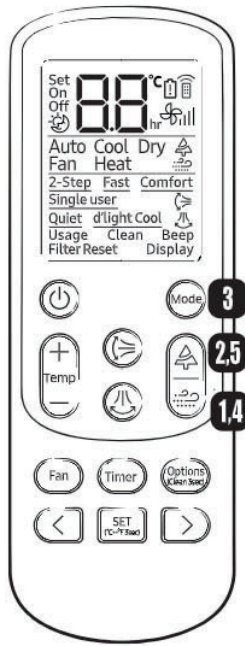

Enter the Option Setup mode.

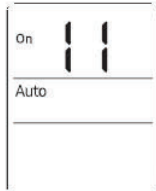



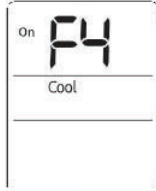





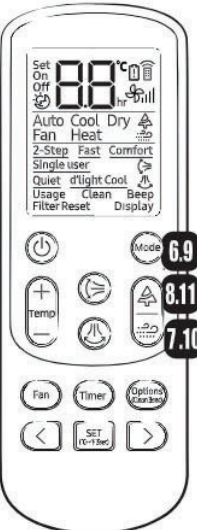

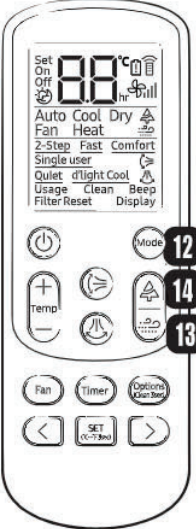



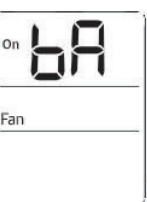

1. Tack out the batteries of remote control.
2. Press the temperature  button simultaneously and insert the battery again.
3. Make sure the remote control display shown as .











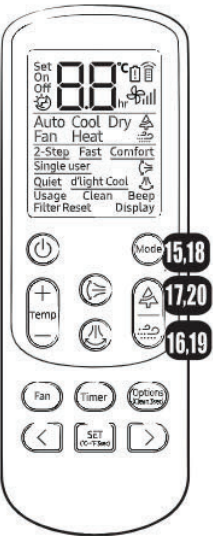





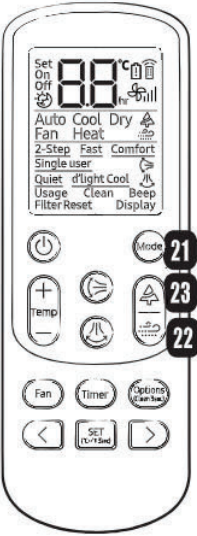

Step 2

Enter the Options Setup mode and select your options according to the following procedure.

	Method	Display
	1 Setting option SEG1 Press the  button the display panel to ↑. Press the  button repeatedly to select . 0 → 1 → 2 → 3 → ... 9 → A → b → c → d → E → F	
	2 Setting option SEG2 Press the  button the display panel to ↑. Press the  button repeatedly to select . 0 → 1 → 2 → 3 → ... 9 → A → b → c → d → E → F	
	3 Press the  button to set Cool mode.	
	4 Setting option SEG3 Press the  button the display panel to ↑. Press the  button repeatedly to select . 0 → 1 → 2 → 3 → ... 9 → A → b → c → d → E → F	
	5 Setting option SEG4 Press the  button the display panel to ↑. Press the  button repeatedly to select . 0 → 1 → 2 → 3 → ... 9 → A → b → c → d → E → F	

	Method	Display
	<p>6</p> <p>Press the  button to set Dry mode.</p>	
	<p>7</p> <p>Setting option SEG5</p> <p>Press the  button the display panel to 5.</p> <p>Press the  button repeatedly to select . 0 → 1 → 2 → 3 → ...</p> <p>g → A → b → c → d → E → F</p>	
	<p>8</p> <p>Setting option SEG6</p> <p>Press the  button the display panel to 0.</p> <p>Press the  button repeatedly to select . 0 → 1 → 2 → 3 → ...</p> <p>g → A → b → c → d → E → F</p>	
	<p>9</p> <p>Press the  button to set Fan mode.</p>	
	<p>10</p> <p>Setting option SEG7</p> <p>Press the  button the display panel to b.</p> <p>Press the  button repeatedly to select . 0 → 1 → 2 → 3 → ...</p> <p>g → A → b → c → d → E → F</p>	
	<p>11</p> <p>Setting option SEG8</p> <p>Press the  button the display panel to A.</p> <p>Press the  button repeatedly to select . 0 → 1 → 2 → 3 → ...</p> <p>g → A → b → c → d → E → F</p>	
	<p>12</p> <p>Press the  button to set Heat mode.</p>	
	<p>13</p> <p>Setting option SEG9</p> <p>Press the  button the display panel to 6.</p> <p>Press the  button repeatedly to select . 0 → 1 → 2 → 3 → ...</p> <p>g → A → b → c → d → E → F</p>	
	<p>14</p> <p>Setting option SEG10</p> <p>Press the  button the display panel to A.</p> <p>Press the  button repeatedly to select . 0 → 1 → 2 → 3 → ...</p> <p>g → A → b → c → d → E → F</p>	

	Method	Display
	<p>15 Press the  button to set Auto mode.</p> <p>16 Setting option SEG11 Press the  button the display panel to 0. Press the  button repeatedly to select . 0 → 1 → 2 → 3 → ... g → A → b → c → d → E → F</p> <p>17 Setting option SEG12 Press the  button the display panel to 1. Press the  button repeatedly to select . 0 → 1 → 2 → 3 → ... g → A → b → c → d → E → F</p> <p>18 Press the  button to set Cool mode.</p> <p>19 Setting option SEG13 Press the  button the display panel to E. Press the  button repeatedly to select . 0 → 1 → 2 → 3 → ... g → A → b → c → d → E → F</p> <p>20 Setting option SEG14 Press the  button the display panel to 0. Press the  button repeatedly to select . 0 → 1 → 2 → 3 → ... g → A → b → c → d → E → F</p>	<div data-bbox="1240 317 1386 512"> <p>Off 01</p> <p>Auto</p> </div> <div data-bbox="1240 890 1386 1085"> <p>Off E0</p> <p>Cool</p> </div>
	<p>21 Press the  button to set Dry mode.</p> <p>22 Setting option SEG15 Press the  button the display panel to 0. Press the  button repeatedly to select . 0 → 1 → 2 → 3 → ... g → A → b → c → d → E → F</p> <p>23 Setting option SEG16 Press the  button the display panel to 1. Press the  button repeatedly to select . 0 → 1 → 2 → 3 → ... g → A → b → c → d → E → F</p>	<div data-bbox="1240 1451 1386 1646"> <p>Off 07</p> <p>Dry</p> </div>



	Method	Display
	<p>24</p> <p>Press the button to set Fan mode.</p>	
	<p>25</p> <p>Setting option SEG17</p> <p>Press the button the display panel to F.</p> <p>Press the button repeatedly to select . 0 → 1 → 2 → 3 → ...</p> <p>g → a → b → c → d → e → F</p>	
	<p>26</p> <p>Setting option SEG18</p> <p>Press the button the display panel to 7.</p> <p>Press the button repeatedly to select . 0 → 1 → 2 → 3 → ...</p> <p>g → a → b → c → d → e → F</p>	
	<p>27</p> <p>Press the button to set Heat mode.</p>	
	<p>28</p> <p>Setting option SEG19</p> <p>Press the button the display panel to c.</p> <p>Press the button repeatedly to select . 0 → 1 → 2 → 3 → ...</p> <p>g → a → b → c → d → e → F</p>	
	<p>29</p> <p>Setting option SEG20</p> <p>Press the button the display panel to 4.</p> <p>Press the button repeatedly to select . 0 → 1 → 2 → 3 → ...</p> <p>g → a → b → c → d → e → F</p>	

Option code :







Model	Option code	
	General	Install
AR07BSFCMWKNCV	011A25-17C0DA-271416-37280D	020010-100000-200101-300335
AR09BSFCMWK/CV	011A25-17C0EA-271A20-37280D	020010-100000-200101-300335
AR12BSFCMWK/CV	011A25-17C0FA-272323-37280D	020010-100000-200101-300335
AR15BSFCMWKNCV	011A25-17C22A-272C38-37180D	020010-100000-200101-300335
AR18BSFCMWK/CV	011A25-15C21B-27353E-37240D	020010-100000-200101-300357
AR24BSFCMWK/CV	011A25-15C24B-274046-37140D	020010-100000-200101-300357

4. Disassembly and Reassembly

◆ Necessary Tools

Item	Remark
<p>+SCREW DRIVER Q'ty 1 ea. To assembly and disassembly the screw</p>	
<p>MONKEY SPANNER Q'ty 1 ea. To assembly and disassembly the Fan motor and Compressor</p>	
<p>- SCREW DRIVER Q'ty 1 ea. To assembly and disassembly the screw</p>	

4-1. Indoor Unit

NO.	Parts	Procedure	Remark
1	PANEL-FRONT	<p>1) Stop the driving of air conditioner and shut off main power supply.</p> <p>2) Detach FILTER PRE from the PANEL FRONT.</p> <p>3) The COVER PANEL is fixed to body by hooks in center and side area.</p> <p>4) Separate the hook pulling end of the COVER PANEL as shown in figures.(Watch out for the damage of hooks)</p>	     

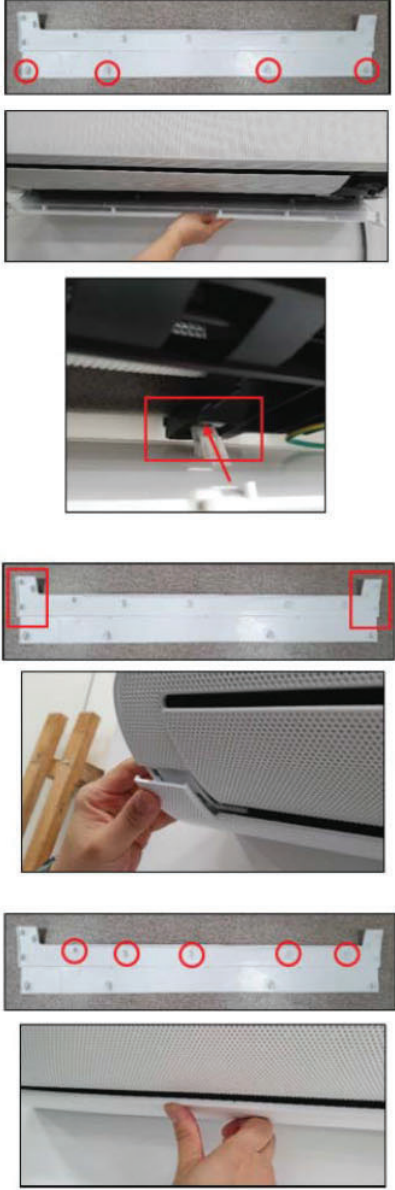

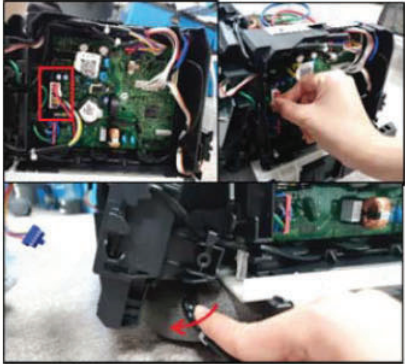
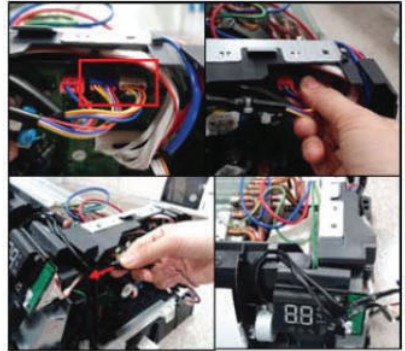
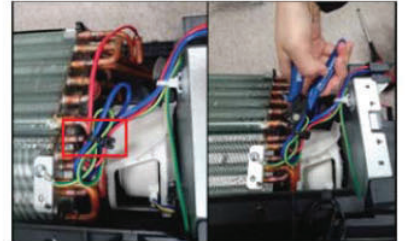

NO.	Parts	Procedure	Remark
1	PANEL-FRONT	<p>⚠ Caution: Assembly of Cover Panel after service end. - Piping and Drain Hose must be careful not to damage and progress must be done with both hands. - Need to check all bottom hooks in holes of the main frame before you push to assemble.</p> <p>⚠ Caution: - Assemble(push) side hooks - Assemble(push) center 5 hooks each.</p>	

NO.	Parts	Procedure	Remark
1	PANEL-FRONT	<p>5) The GRILLE INLET is fixed to body by hooks in the center and side area.</p> <p>6) Separate the hook pulling end of the GRILLE INLET as shown in figures.(Watch out for the damage of hooks)</p> <p>7) To detach the PANEL FRONT from the main frame, unfasten 2 screws at the bottom. (use (+) Screw Driver)</p> <p>8) To detach the PANEL FRONT from the main frame, loosen 4 hook structures. When separate the hooks: pull out each ribs near the hooks as shown in figures. (Watch out for the damage of hooks)</p>	      

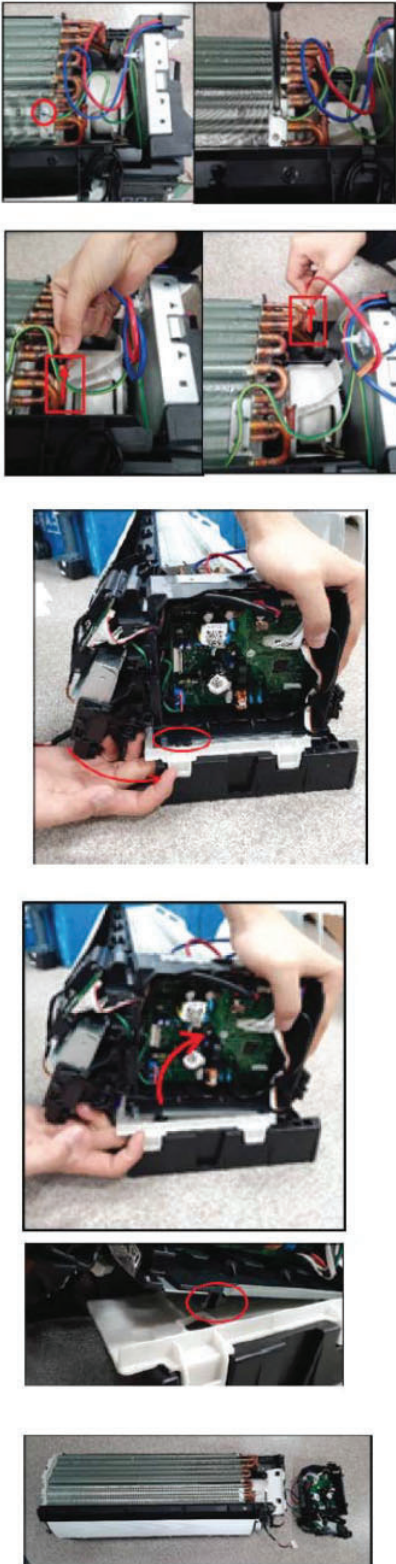
NO.	Parts	Procedure	Remark
1	PANEL-FRONT	9) Raise the PANEL FRONT upward as shown in the figure to separate the 3 hooks.	 
2	CONTROL-IN	<p>10) To open the CONTROL-IN, raise the side flanges of the PLATE-RIGHT at an angle and unlock 2 hooks.</p> <p>11) To detach the CONTROLIN, unfasten a screw back of the PLATE-LEFT as shown in figures. (use (+) Screw Driver)</p>	  



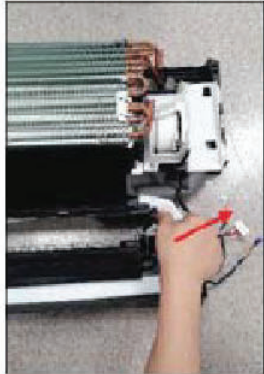

NO.	Parts	Procedure	Remark
2	CONTROL-IN	<p>12)Separate Fan Moter wire as shown in figures.</p> <p>⚠ Caution: When you separate the connector, pull pressing the locking button.</p> <p>13)Separate Blade Moter wire as shown in figures.</p> <p>⚠ Caution: When you separate the connector, pull pressing the locking button.</p> <p>14)Cut off the Cable Tie tied up wires.</p>	  

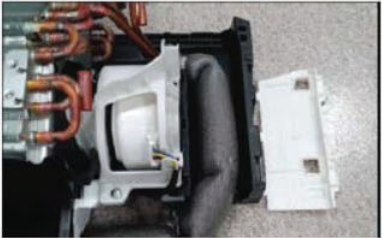
NO.	Parts	Procedure	Remark
2	CONTORL IN	<p>15) Unfasten a screw of the Ground wire and pick up Temperature wires from ASSY EVAP. (Use (+) Screw Driver.)</p> <p>16) The CONTROL-IN is fixed to HOLER PIPE by a hook bottom of the case as shown in the last figure. (Please loosen remaining connectors before detaching CASECONTROL.</p> <p>⚠ Caution: When you separate the connector, pull pressing the locking button</p> <p>17) Put down of the HOLDER PIPE and push up the hook and lean side the case as shown in figures.</p>	

NO.	Parts	Procedure	Remark
3	TRAY DRAIN	18) To detach the TRAY DRAIN from the main frame, pull the bottom of the TRAY DRAIN and it leans toward to you as shown in figures.	
		19) Pull out the Drain Hose.	  

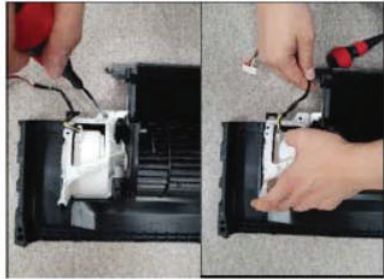
NO.	Parts	Procedure	Remark
4	EVAPORATOR	<p>20) The HOLDER PIPE is fixed to body by 2 hooks as shown in the figure.</p> <p>21) To detach the HOLDER PIPE from the main frame,loosen 2 hook structhres. When separate hooks: Use the (-) Screw Driver. Insert the (-) Screw Driver into the gap of the hook and lean to the Moter side as shown in figures. (Watch out for the damate of hooks)</p> <p>22)Remove the HOLDER PIPE.</p> <p>23)Unfasten a screw of the Fan Moter side. (Use (+) Screw Driver.)</p>	   
		<p>24)Unfasten 2 screws of the opposite side of the Fan Moter. (Use (+) Screw Driver.)</p>	

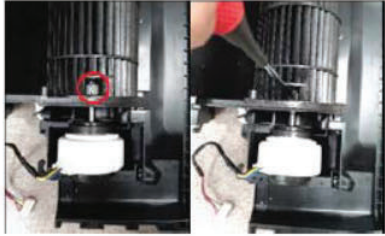

NO.	Parts	Procedure	Remark
4	EVAPORATOR	<p>25) Pull up the EVAPORATOR of the opposite side of the Fan Moter</p> <p>26) loosen a hook of the Fan Moter side.</p> <p>27) Pull up the EVAPORATOR toward to you.</p>	     





NO.	Parts	Procedure	Remark
5	FAN MOTOR & CROSS FAN	<p>28) Unfasten a screw on the COVER MOTER. (Use (+) Screw Driver.)</p> <p>29) Unwind the Moter Wire.</p> <p>30) Detach the COVER MOTER.</p>	  
		<p>31) Unfasten a screw of the CROSS FAN a little. (Use (+) Screw Driver.)</p> <p>32) Raise up the CROSS FAN of the left side and pull out from the Moter.</p>	  

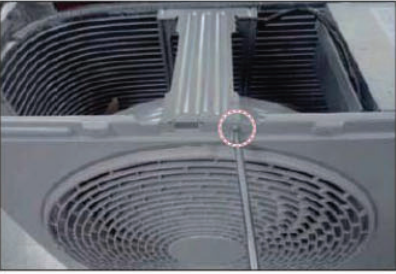



4-2. Outdoor Unit (N-SI/N-WW)

AR09BSFCMWKXCV

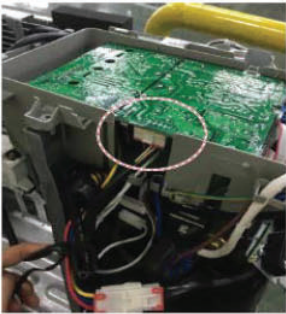

AR12BSFCMWKXCV

NO.	Parts	Procedure	Remark
1	Common work	1) Loosen each screws and detach the cabi Top cover.	 A photograph of a white Samsung outdoor air conditioning unit. Two screws on the top edge of the unit are circled in red, indicating they need to be loosened.
		2) Loosen screws of the cabi front and detach it.	  Two close-up photographs showing the process of loosening screws. The top image shows a screw being loosened on the top cover. The bottom image shows a screwdriver being used to loosen a screw on the front panel of the unit.

NO.	Parts	Procedure	Remark
		<p>3) Remove the 4 Cond Bar from the holder of outdoor unit cabinet. * This process is supported by heating models only</p>	
		<p>4) Loosening screws from the Cabinet Front Lh and detach it. 5) Loosening screws from the Cabinet Side Rh and detach it.</p>	  

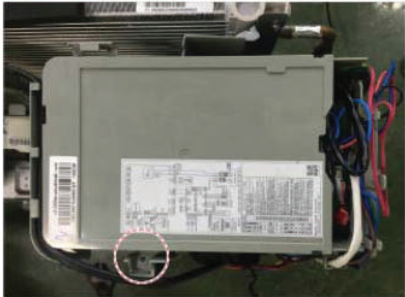
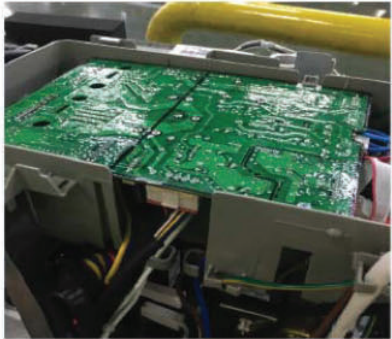
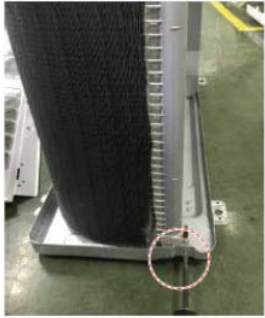
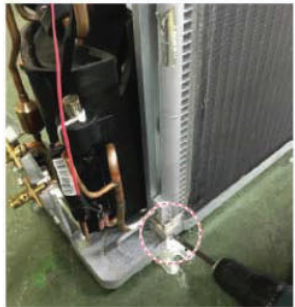

NO.	Parts	Procedure	Remark
2	Fan & Motor	<p>1) Detach the Nut Flange like the picture on the right side. (Turn clockwise because the screw is left-handed.) (Use Monkey Spanner.)</p> <p>2) Detach the Fan Propeller. 3) Loosen 4 fixing screws to detach the Motor. (Use Monkey Spanner.)</p> <p>4) Disconnect the wire between Ass'y Control Out and Motor.</p>	  
		<p>5) Loosen fixing bolts and detach the Bracket Motor</p>	





NO.	Parts	Procedure	Remark
3	Assy Control Out	<p>1) To remove the Cover control box : Pull the motor wire is allow sufficient space as shown on the right side and then remove the screw.</p> <p>2) Detach several connectors from the Assy Control Out.</p> <p>3) Detach several connectors from the PCB of Assy Control Out.</p> <p>1) Release the refrigerant at first.</p> <p>2) Loosening screw on both sides.</p> <p>3) Disassemble the pipes in both inlet and outlet with welding torch.</p> <p>4) Detach the Heat Exchanger.</p>	   



NO.	Parts	Procedure	Remark
5	Compressor	<p>1) Loosen the locking nut and detach the Compressor Lead Wire. (Use Monkey Spanner.)</p> <p>2) Loosen the bolts at the bottom of Compressor like the picture on the right side. (Use Monkey Spanner.)</p>	 

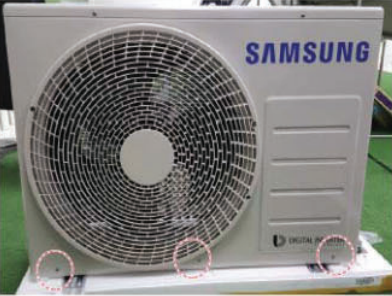

4-3. Outdoor Unit (Q-480)

AR18BSFCMWKXCV

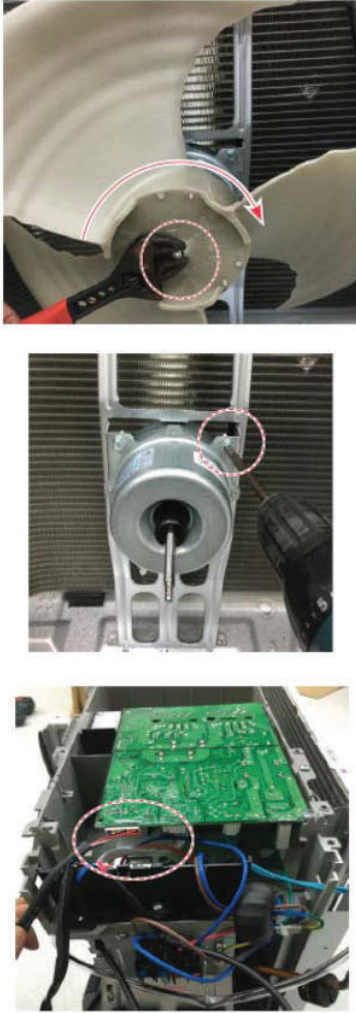
NO.	Parts	Procedure	Remark
1	COMMON WORK	<p>1) Loosen fixing screws from the cabi side Rh and detach it.</p> <p>2) Loosen each screws and detach the Cabi Top Cover.</p> <p>3) Loosen fixing screws from the cabi side.</p>	
		<p>4) Loosen fixing screws from the cabi side Rh and detach it.</p>	

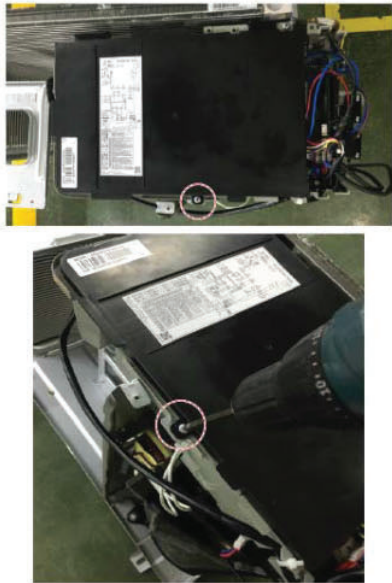
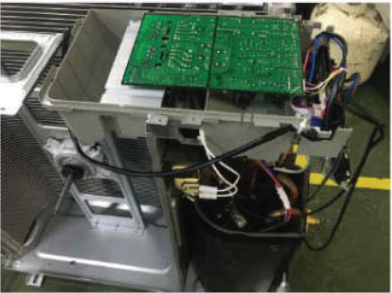
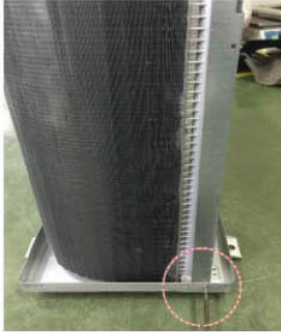

NO.	Parts	Procedure	Remark
1	COMMON WORK	<p>5) Loosen fixing screws from the cabi front and detach it.</p> <p>6) L oosen fixing screws from the Cabi left and detach it and Remove the 4 Cond Bar from the holderof outdoor unit cabinet.</p>	    

NO.	Parts	Procedure	Remark
2	Fan & Motor	<p>1) Detach the Nut Flange like the picture on the right side. (Turn clockwise because the screw is left-handed.) (Use Monkey Spanner.)</p> <p>2) Detach the Fan Propeller.</p> <p>3) Loosen 4 fixing screws to detach the Motor. (Use Monkey Spanner.)</p> <p>4) Disconnect the wire between Assy Control Out and Motor.</p>	
		5) Loosen fixing bolts and detach the Bracket Motor	

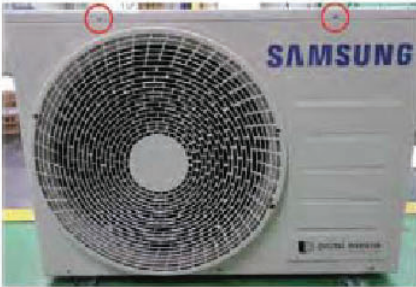

NO.	Parts	Procedure	Remark
3	Assy Control Out	<p>1) To remove the Cover control box : Pull the motor wire is allow sufficient space as shown on the right side and then remove the screw.</p> <p>2) Detach several connectors from the Assy Control Out.</p> <p>3) Detach several connectors from the PCB of Assy Control Out.</p>	 
4	Heat Exchanger	<p>1) Release the refrigerant at first.</p> <p>2) Loosen ng screw on both sides.</p> <p>3) Disassemble the pipes in both inlet and outlet with welding torch.</p> <p>4) Detach the Heat Exchanger.</p>	 

4-4. Outdoor Unit (Q-480)

AR24BSFCMWKXCV

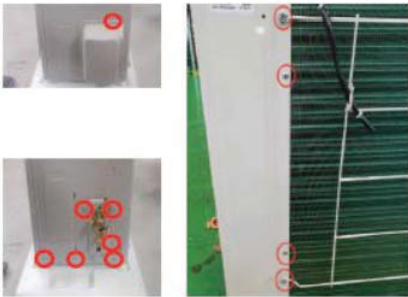
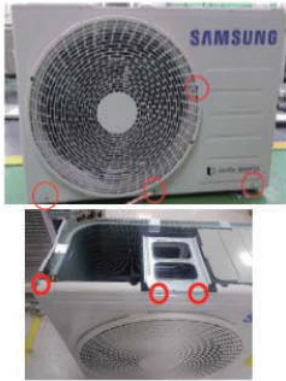
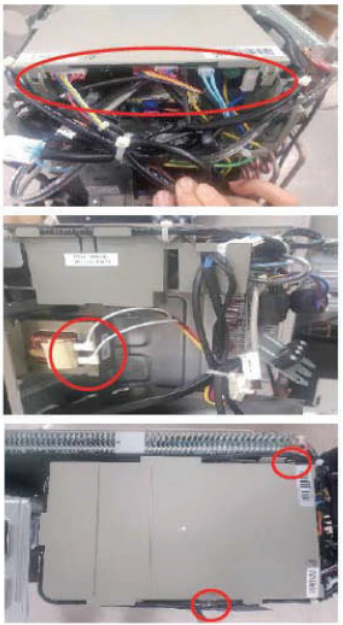
NO.	Parts	Procedure	Remark
1	Common Work	1) Loosen 8 fixing screw on each side of the Cabinet-Top.(Use +Screw Driver)	
2	Assy cover control	1) Unscrew and remove a screw of Cover-Control. (Use + Screw Driver)	
3	Outdoor and indoor unit's power cable and communication cable	<p>⚠ Caution: Make sure shutting the power off supply before disassembling.</p> <p>1) Unscrew 2 fix screws under cable holders and remove. 2) Get rid of cable tie of communication cable. 3) Unscrew the numbers of screws on terminal block and separate power and communication 'Ring' cables from terminal block. 4) Unscrew earth-wire screws and separate it.</p>	

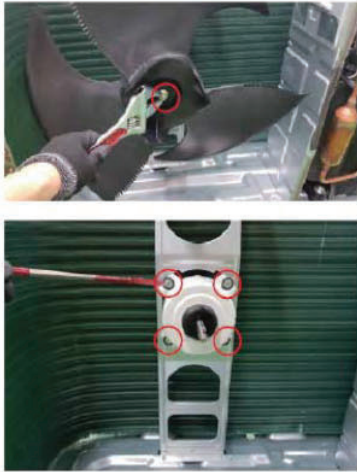
NO.	Parts	Procedure	Remark
4	ASSY CABINET SIDE RH	1) Unscrew and remove 11 screws on Cabinet-side RH. (Use + Screw Driver)	
5	ASSY CABINET FRONT	1) Unscrew and remove 7 screws on Assy Cabinet Front. (Use + Screw Driver)	
6	ASSY CONTROL OUT	<p>1) Disconnect and Separate 5 Connectors of wire from Assy Control Out.</p> <p>2) Separate Comp wire from each object.</p> <p>⚠ Caution: (When you disconnect BLDC motor connector you have to cut the power off first and disconnect 30 seconds later And Make sure that is impossible to connect and disconnect BLDC motor connector when the power is on)</p> <p>3) Unscrew and remove 2 screws on of Assy Control out.</p>	

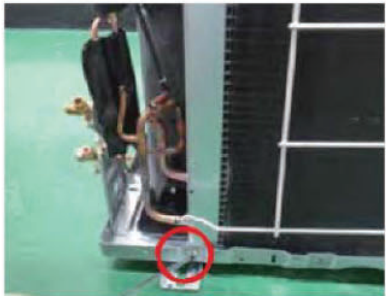
NO.	Parts	Procedure	Remark
7	Fan propeller + Motor	1) Take Fan Propeller apart. 2) Unscrew and remove 4 screws on Motor to take apart Motor. (Use + Screw Driver)	
8	ASSY BRACKET MOTOR	1) Unscrew and remove 2 screws on to take apart Bracket Motor. (Use + Screw Driver)	
9	Heat Exchanger	1) Purge the Refrigerant first. 2) Unscrew the fix screw. 3) Separate the pipe from the Entrance and Exist by using a welder. 4) Separate Heat Exchanger from Unit. ⚠ Caution: When removing the Compressor, Heat Exchanger, and Pipe, Purge the Refrigerant inside the Compressor completely and remove the pipe with a welding flame.	

5. ASSY CONTROL

5-1 ASSY KIT CODE DB92-04845U

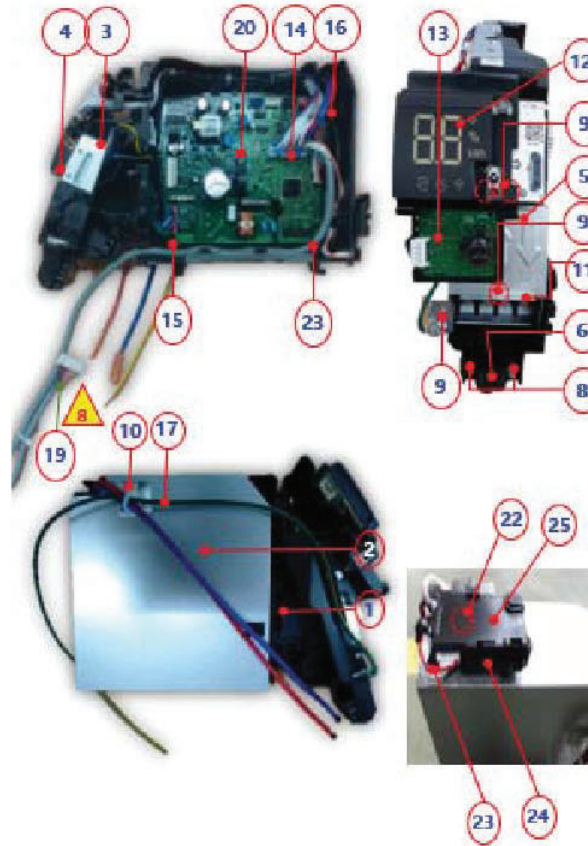

No	NAME	CODE	Q'ty	unit
1	CASE CONTROL-IN	DB61-07432A	1	EA
2	PLATE CONTROL-LF	DB61-07431A	1	EA
3	PLATE CONTROL-LOW	DB61-07428A	1	EA
4	PLATE CONTROL-UP	DB61-07429A	1	EA
5	PLATE CONTROL-SUB	DB61-07427A	1	EA
6	HOLDER-WIRE	DB61-05871A	1	EA
7	SCREW-TAPPING	6002-001163	1	EA
8	SCREW-TAPPING	6002-000213	2	EA
9	SCREW-SPECIAL	6009-001001	3	EA
10	CABLE TIE	6501-001075	1	EA
11	TERMINAL BLOCK_4P_CV	DB37-00033B	1	EA
12	ASSY PCB DISPLAY_88_WIFI	DB92-04833B	1	EA
14	SENSOR HUMIDITY	DB32-00272A	1	EA
15	ASSY CONNECTOR WIRE-POWER	DB93-17169A	1	EA
16	ASSY CONNECTOR WIRE-COMM	DB93-17055B	1	EA
17	ASSY CONNECTOR WIRE-EARTH	DB93-14245D	1	EA
19	ASSY CONNECTOR WIRE-FJM	DB93-17178A	1	EA
20	ASSY PCB MAIN_DLX_GLOBAL	DB92-04839A	1	EA

5-2 ASSY KIT CODE DB92-04842N

Model	KIT OUT
AR09BSFCMWKXCV	DB92-04842N
AR12BSFCMWKXCV	DB92-04842N

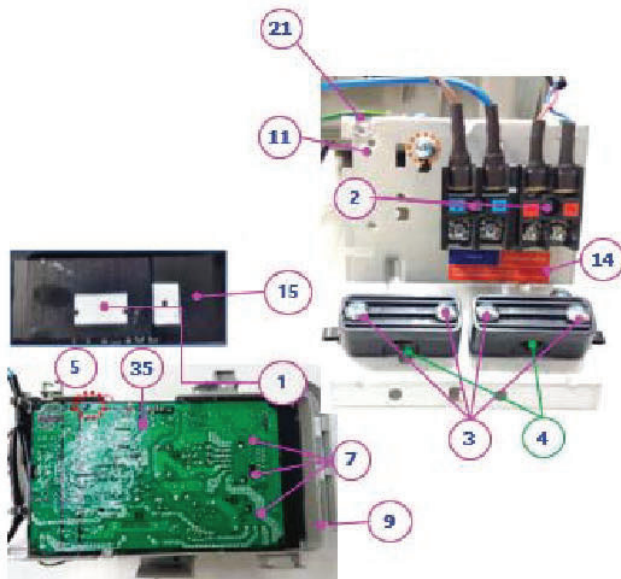
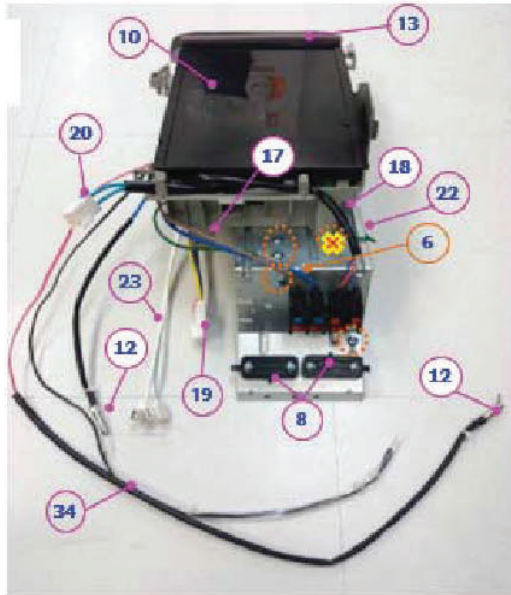

No	NAME	CODE	Z	Unit
1	ASSY-THERMAL GREASE	0205-000178	0.002	Kg
2	SCREW-MACHINE (TB)	6001-000722	2	EA
3	SCREW-TAPPING (CLAMP 4EA)	6002-000234	4	EA
4	SCREW-TAPPING (CLAMP 2EA, CASE 1EA)	6002-000239	3	EA
5	SCREW-TAPPING (PBA)	6002-000630	1	EA
6	SCREW-TAPPING (EARTH)	6009-001001	4	EA
7	ASSY-SCREW MACHINE (H/S???)	DB91-00933A	3	EA
8	HOLDER-WIRE CLAMP	DB61-00250A	2	EA
9	CASE CONTROL LOW (WW, SI,Q-480)	DB61-06722A	1	EA
10	COVER CONTROL OUT (WW, SI)	DB63-04234A	1	EA
11	PLATE CONTROL(N-SI)	DB61-05897C	1	EA
12	SPRING	DB81-00635A	2	EA
13	SEAL	DB62-11637T	0.153	mm
14	LABEL	DB98-34030A	1	EA
15	HEAT SINK	DB62-13008A	1	EA
16	TERMINAL BLOCK	DB65-00274A	1	EA
16	TERMINAL BLOCK	DB37-00036B	1	EA
17	ASSY CONNECTOR WIRE-POWER	DB93-16371A	1	EA
18	ASSY CONNECTOR WIRE-COMM	DB93-16402A	1	EA
19	ASSY CONNECTOR WIRE-COMP	DB93-09497F	1	EA
20	ASSY CONNECTOR WIRE-AC SIGNAL	DB93-17177A	1	EA
21	ASSY CONNECTOR WIRE-EARTH	DB93-12121B	1	EA
22	ASSY CONNECTOR WIRE-EARTH	DB93-12121B	1	EA
23	ASSY CONNECTOR WIRE-REACTOR	DB93-17175C	1	EA
34	SENSOR TEMP	DB95-05164A	1	EA
35	ASSY MODULE	DB92-04837D	1	EA

5-3 ASSY KIT CODE DB92-04849D

AR18BSFCMWKXCV

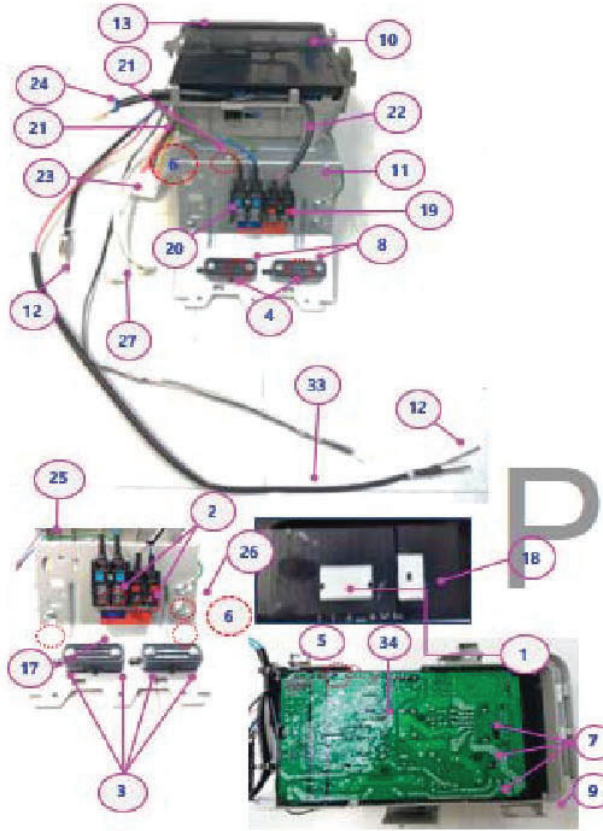

No	NAME	CODE	Q'ty	unit
1	ASSY-THERMAL GREASE	0205-000178	0.002	Kg
2	SCREW-MACHINE	6001-000722	2	EA
3	SCREW-TAPPING	6002-000234	4	EA
4	SCREW-TAPPING	6002-000239	3	EA
5	SCREW-TAPPING	6002-000630	1	EA
6	SCREW-SPECIAL	6009-001001	4	EA
7	ASSY-SCREW MACHINE	DB91-00933A	3	EA
8	HOLDER-WIRE CLAMP	DB61-00250A	2	EA
9	CASE CONTROL LOW	DB61-06722A	1	EA
10	COVER CONTROL OUT	DB63-04234A	1	EA
11	PLATE CONTROL	DB61-04690B	1	EA
12	SPRING	DB81-00635A	2	EA
13	SEAL	DB62-11637T	0.153	mm
17	LABEL	DB98-34030A	1	EA
18	HEAT SINK	DB62-13008A	1	EA
19	TERMINAL BLOCK	DB65-00274A	1	EA
20	TERMINAL BLOCK	DB37-00036B	1	EA
21	ASSY CONNECTOR WIRE-POWER	DB93-16371A	1	EA
22	ASSY CONNECTOR WIRE-COMM	DB93-16402A	1	EA
23	ASSY CONNECTOR WIRE-COMP	DB93-09497B	1	EA
24	ASSY CONNECTOR WIRE-AC SIGNAL	DB93-17177A	1	EA
25	ASSY CONNECTOR WIRE-EARTH	DB93-12121B	1	EA
26	ASSY CONNECTOR WIRE-EARTH	DB93-12121B	1	EA
27	ASSY CONNECTOR WIRE-REACTOR	DB93-17175A	1	EA
27	ASSY CONNECTOR WIRE-REACTOR	DB93-17175C	1	EA
33	SENSOR TEMP	DB32-00257A	1	EA
34	ASSY MODULE	DB92-04837D	1	EA

5-4 ASSY KIT CODE DB92-04843H

AR24BSFCMWKXCV

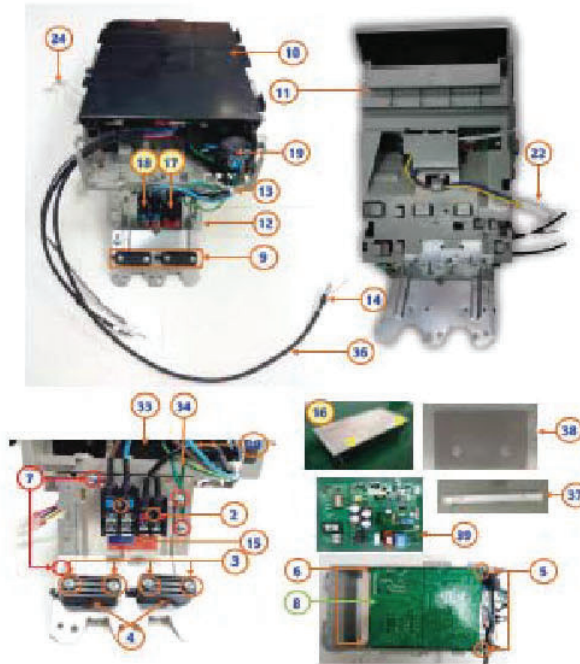

NO	NAME	CODE	Q'ty	Unit
1A	SSY-THERMAL GREASE	0205-000178	0.002	KG
25	CREW-MACHINE (TB)	6001-0007222	2	EA
35	CREW-TAPPING	6002-000234	4	EA
45	CREW-TAPPING	6002-000239	3	EA
55	CREW-TAPPING	6002-000536	2	EA
65	CREW-TAPPING	6002-001306	2	EA
75	CREW-SPECIAL	6009-001001	4	EA
8A	SSY-SCREW MACHINE	DB91-00933A	7	EA
9	HOLDER-WIRE CLAMPD	B61-00250A	2	EA
10	CASE CONTROL-UPPER	DB61-04677A1	1	EA
11	CASE CONTROLD	B61-05917A1	1	EA
12	PLATE CONTROLD	B61-04698B	1	EA
13	CABLE TIED	B65-10088D	1	EA
14	SPRING ETC-SENSORD	B81-00635A	1	EA
15	LABEL	DB98-34030A1	1	EA
16	HEATSINKD	B62-13009A	1	EA
17	TERMINAL BLOCK	DB65-00274A1	1	EA
18	TERMINAL BLOCK	DB37-00036B	1	EA
19	ASSY CONNECTOR WIRE-POWER	DB93-17207A1	1	EA
20	ASSY CONNECTOR WIRE-COMM	DB93-16402A	1	EA
21	ASSY CONNECTOR WIRE-AC SIGNALD	B93-16403A	1	EA
22	ASSY CONNECTOR WIRE-COMP	DB93-10905D	1	EA
24	ASSY CONNECTOR WIRE-REACTORD	B93-17175A	1	EA
27	ASSY CONNECTOR WIRE-DC SIGNAL	DB93-17173A	1	EA
33	ASSY CONNECTOR WIRE-EARTH D	B93-12121B1	1	EA
34	ASSY CONNECTOR WIRE-EARTH	DB93-12121B1	1	EA
36	SENSOR TEMP D	B32-00257A1	1	EA
37	SUPPORT-PCB	DB61-05796A1	1	EA
38	RUBBER	DB67-01713A1	1	EA
39	ASSY PCB INVERTER	DB92-04838A	1	EA

6-2 Outdoor Unit (All models)

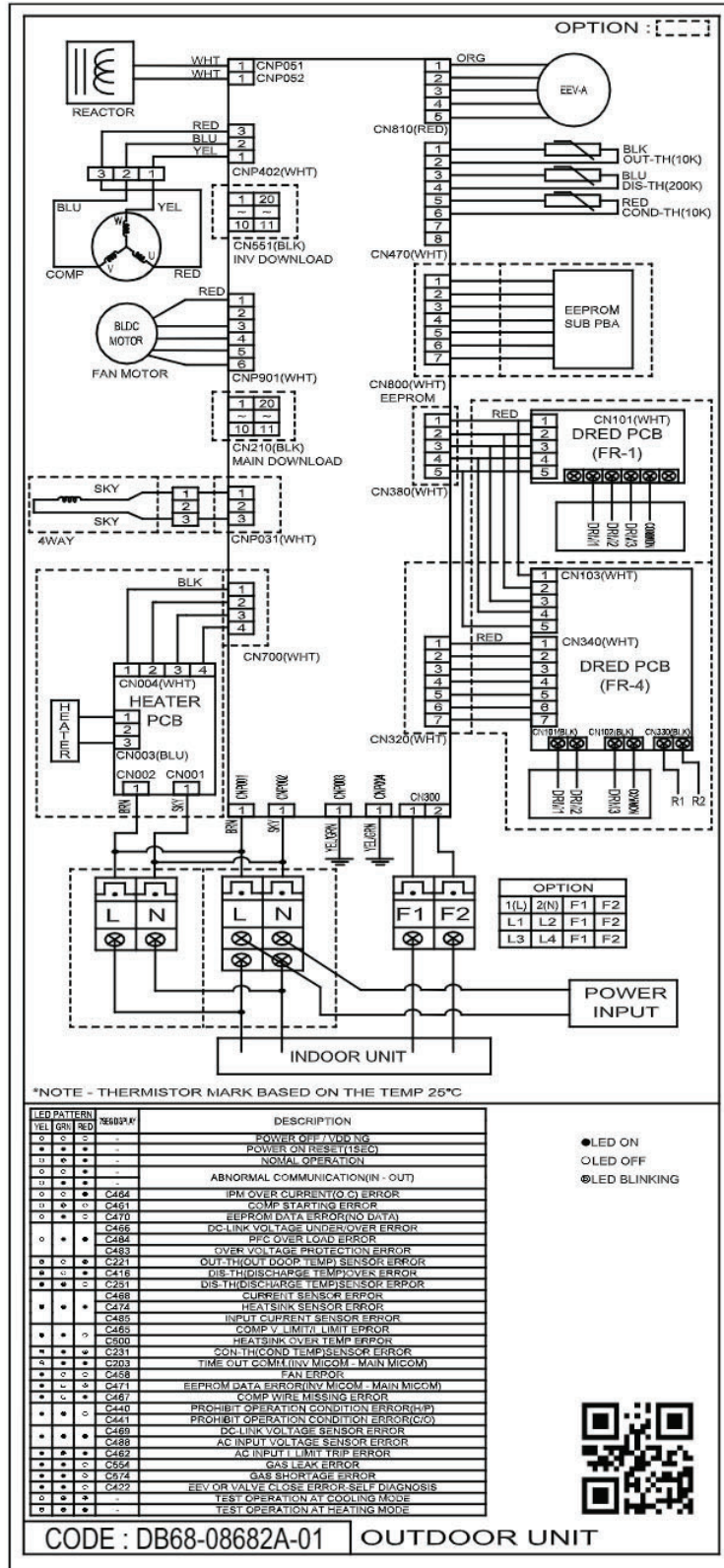

7. PCB Diagram

7-1 Indoor Main PCB CODE DB92-04839A

AR09BSFCMWKNCV
 AR12BSFCMWKNCV
 AR18BSFCMWKNCV
 AR24BSFCMWKNCV

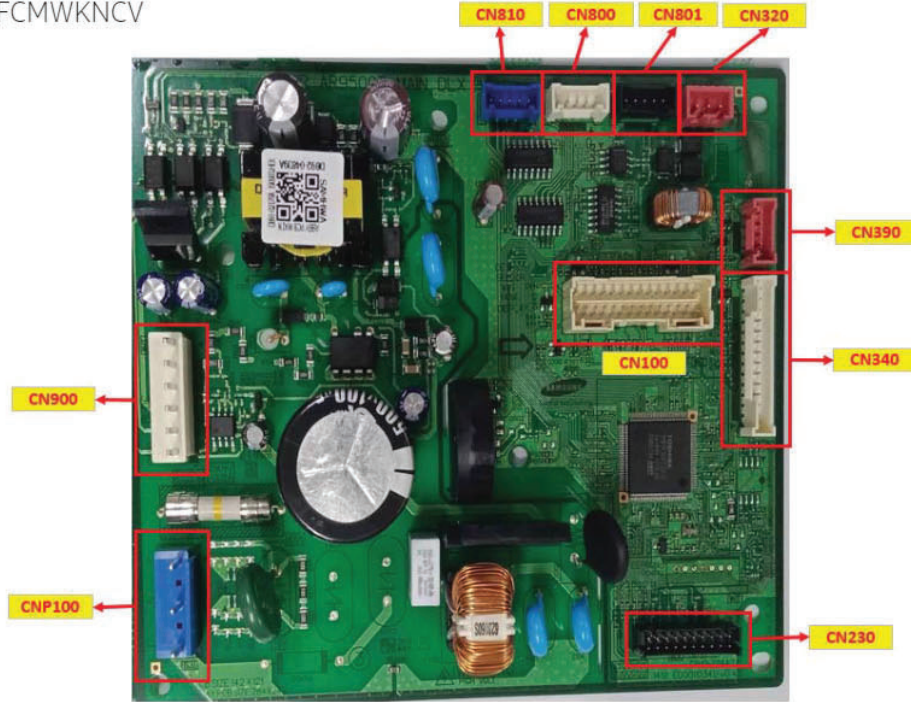

CN810 : STEP MOTOR(V-Blade)	CN800 : STEP MOTOR(H-BLADE1)	CN801 : STEP MOTOR(H-BLADE3)	
#1: 12V	#1: 12V	#1: 12V	
#2: SIGNAL1	#2: SIGNAL1	#2: SIGNAL1	
#3: SIGNAL2	#3: SIGNAL2	#3: SIGNAL2	
#4: SIGNAL3	#4: SIGNAL3	#4: SIGNAL3	
#5: SIGNAL4	#5: SIGNAL4	#5: SIGNAL4	
CN230 : DOWNLOAD	CN430 : FJM SUB	CN100 : DISPLAY&Thermistor&Wifi	
#1: COM1_RXD	#1: COM2_RXD	#1: LED_DIO	#2: 5VDC
#2: COM1_TXD	#2: COM2_TXD	#3: LED_CLK(DIS)	#4: GND
#3: nTRST	#3: COM2_INVERSE	#5: LED_RST(DIS)	#6: H_ROOM_TEMP
#4: TDO	#4: COM2_ENABLE	#7: POWER_SW	#8: HUM_SENSOR
#5: TCK	#5: EXT_CTRL	#9:GND	#10: ROOM_TEMP
#6: TDI	#6: COMP_CHK	#11:5VDC	#12: GND
#7: TMS	#7: ERROR_CHK	#13: REMOCON_INT(DIS)	#14: EVA_IN_TEMP
#8: TraceCLK	#8: COM2_VCC_PS_OUT	#15: ADDRESS_SW(DIS)	#16: GND
#9: GND	#9: GND	#17: MAIN_RX(DIS_WIFI)	#18: EVA_OUT_TEMP
#10: 5VDC	#10: 12VDC	#19: MAIN_TX(DIS_WIFI)	#20: GND
#11: 5VDC	#11: COM2_PCTRL_MICOM	#21: WIFI_CONTROL(DIS_WIFI)	#22: NULL
#12: BOOT	#12:COM2_VCHECK_A	#23: 12VDC	#24: NULL
#13: RESET	#13:COM2_VCHECK_B	#25: MDS_2(DIS_DETECT)	#26: NULL
#14: Trace3	#14:COM2_MICOM_AD	#27: MDS_1(DIS_DETECT)	#28: 5VDC_1
#15: NULL	CNP100 : AC POWER	CN900 : BLDC MOTOR	
#16: NULL	#1 : L	#1: 310VDC	
#17: GND	#2 : NULL	#2: NULL	
#18: Trace2	#3 : N	#3: AGND	
#19: Trace1	#4 : NULL	#4: 15VDC	
#20: Trace0	#5 : GND	#5: MOTOR SIGNAL	
CN390 : WIFI	CN320 : 485COMM	#6: FEEDBACK SIGNAL	
#1: MAIN_RX	#1: RX		
#2: MAIN_TX	#2: TX		
#3: CONTROL			
#4: GND			
#5: 12V			

7-2 Outdoor Main PCB CODE DB92-04837D

AR09BSFCMWKXCV
AR12BSFCMWKXCV
AR18BSFCMWKXCV

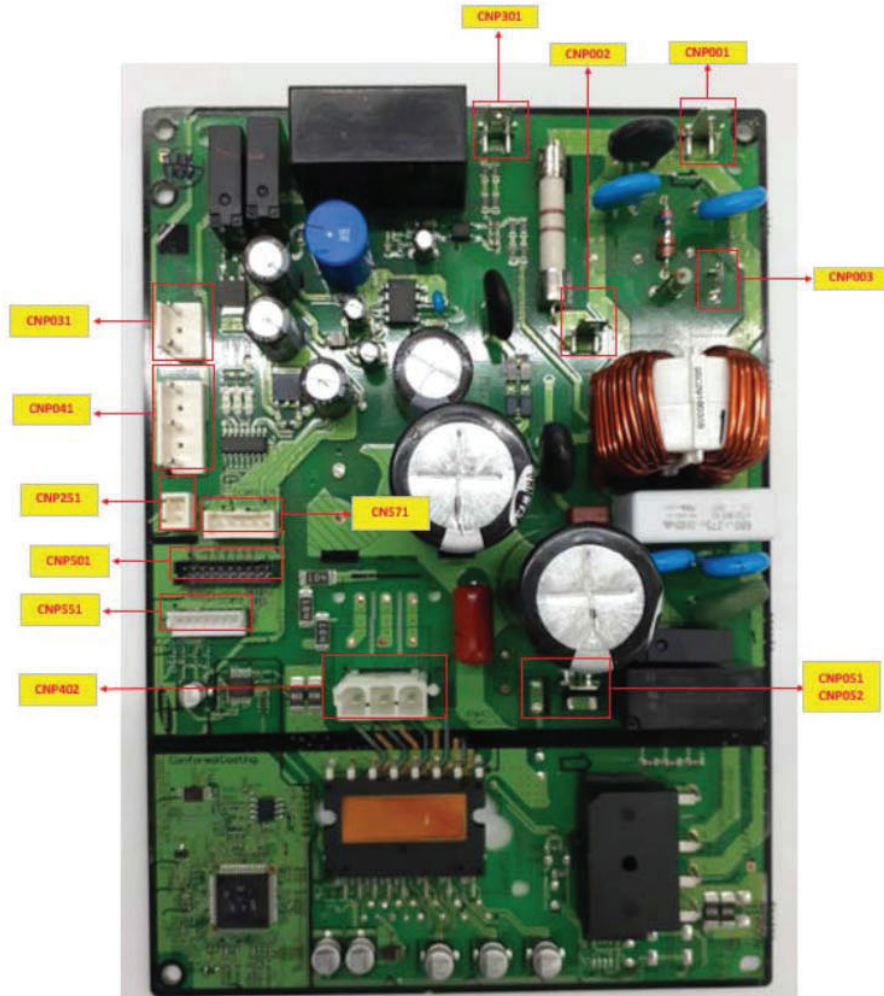

CNP001 : POWER(N)		CNP002 : POWER(L)	
#1 : POWER(N)		#1 : POWER(L)	
CNP003 : EARTH		CNP301 : COMM (C)	
#1 :EARTH		#1 : COMM (C)	
CNP051,CNP052 : REACTOR		CNP401 : COMP	
#1 :REACTOR SIGNAL		#1:COMP SIGNAL(W)	
#2 :REACTOR SIGNAL		#2:COMP SIGNAL(V)	
		#3:COMP SIGNAL(U)	
CNP551 : EEPROM		CNP501 : DOWNLOAD	
#1:GND	#5:EEP_SO_MICOM_RX	#1 :RXD	#9,17:GND
#2:NULL	#6:EEP_SI_MICOM_TX	#2:TXD	#10,11:5VDC
#3:5VDC	#7:EEP_CLK	#3:BOOT	#12,13,15,16:NULL
#4:EEP_CS		#4:TDO	#14:TRACE3
		#5:TCK	#18:TRACE2
		#6:TDI	#19:TRACE1
		#7:TMS	#20:TRACE0
		#8:TRACECLK	
CN251 : OLP SENSOR		CNP571 : ECO-DOWNLOAD	
#1: OLP SENSOR		#1:5VDC	#4:GND
#2: GND		#2:RXD_INV	#5:NULL
		#3:TXD_INV	
CNP041 : AC FAN MOTOR		CNP031 : 4WAY	
#1 :AC	#4:NULL	#1:AC SIGNAL	
#2:NULL	#5:AC	#2:NULL	
#3:MOTOR SIGNAL		#3:AC SIGNAL	

7-3 Outdoor PCB Inverter CODE DB92-04838A

AR24AVFAAWKXPR

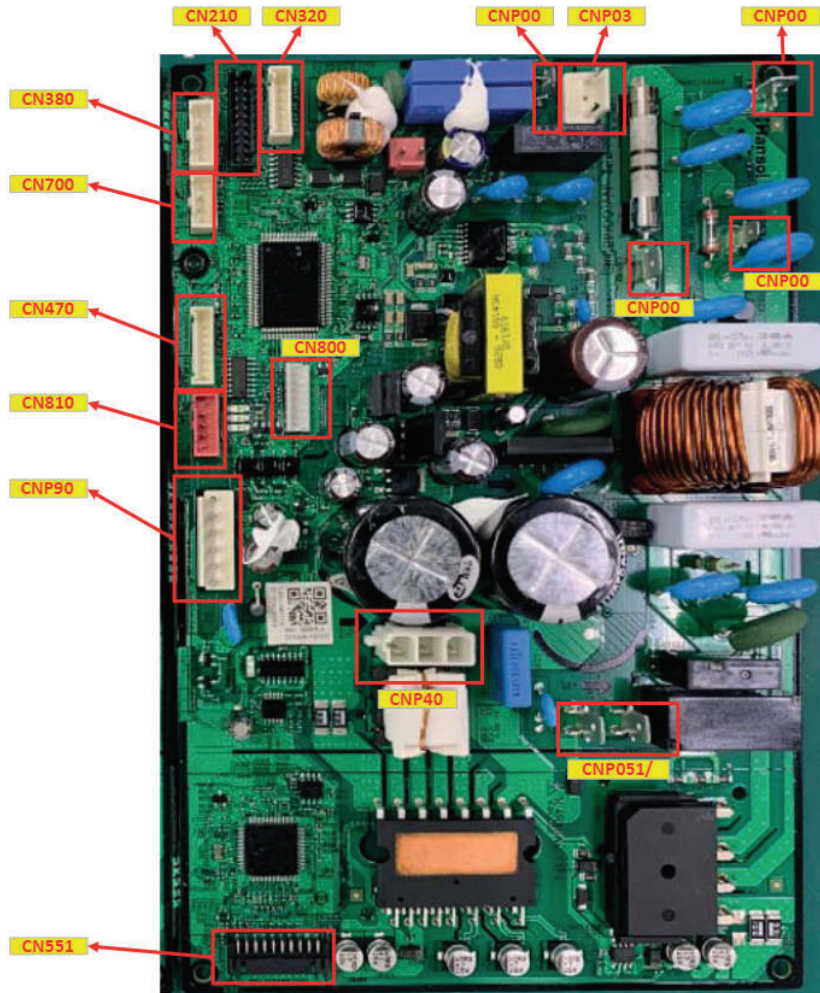

CNP001 : POWER_L	CN551 : INV_DOWNLOAD	CN320 : SUB COMM
#1: L	#1: RXD_INV	#1: 5VDC
CNP002 : POWER_N	#2: TXD_INV	#2: ENABLE
#1: N	#3: BOOT	#3: INVERSE
CNP003 : POWER_GND	#4: TDO_INV	#4: TXD
#1: GND	#5: TCK_INV	#5: RXD
CNP004 : COMM_GND	#6: TDI_INV	#6: GND
#1: GND	#7: TMS_INV	#7: 12VDC
CNP051/052 : REACTOR	#8: nTRST_INV	CN210 : MAIN_DOWNLOAD
#1: REACTOR#1	#9: GND	#1: RXD_MAIN
#1: REACTOR#2	#10: 5VDC	#2: TXD_MAIN
CNP402 : COMP	#11: 5VDC	#3: BOOT
#1: COMP_W	#12: NULL	#4: TDO_MAIN
#2: COMP_V	#13: NULL	#5: TCK_MAIN
#3: COMP_U	#14: NULL	#6: TDI_MAIN
CNP901 : BLDC MOTOR	#15: NULL	#7: TMS_MAIN
#1: 310VDC	#16: NULL	#8: TRACECLK_MAIN
#2: NULL	#17: GND	#9: GND
#3: AGND	#18: DA_CLK	#10: 5VDC
#4: 15VDC	#19: DA_CS	#11: 5VDC
#5: MOTOR SIGNAL	#20: DA_DATA	#12: NULL
#6: FEEDBACK SIGNAL	CN810 : EEV	#13: NULL
CN470 : THERMISTOR	#1: SIGNAL1	#14: TRACE3_MAIN
#1: OUT_TH	#2: SIGNAL2	#15: NULL
#2: GND	#3: SIGNAL3	#16: NULL
#3: DIS_TH	#4: SIGNAL4	#17: GND
#4: GND	#5: 12VDC	#18: TRACE2_MAIN
#5: COND_TH	CN700 : HEATER	#19: TRACE1_MAIN
#6: GND	#1: 12VDC	#20: TRACE0_MAIN
#7: OLP_TH	#2: GND	CN380 : DRED
#8: GND	#3: HEATER_N	#1: DRED1
CN800 : EEPROM	#4: HEATER_L	#2: DRED2
#1: GND	CNP031 : 4WAY	#3: DRED3
#2: NULL	#1: AC	#4: GND
#3: 5VDC	#2: NULL	#5: 5VDC
#4: EEP_CS	#3: AC	
#5: EEP_SO		
#6: EEP_SI		
#7: EEP_CLK		

7-4 DISPLAY PCB

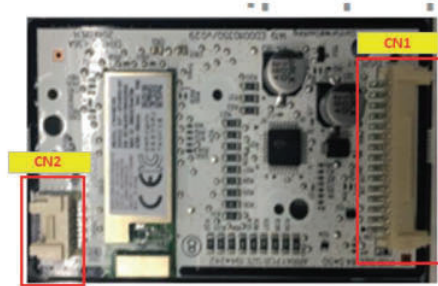

CN1 : DISPLAY	CN2: DETECT
#1: LED_DIO	#1:5V_1
#2: LED_CLK(DIS)	#2GND
#3: LED_RST(DIS)	#3:MDS_1
#4: POWER_SW	#4:MDS_2
#5:GND	
#6:5VDC	
#7: REMOCON_INT(DIS)	
#8: ADDRESS_SW(DIS)	
#9: MAIN_RX(DIS_WIFI)	
#10: MAIN_TX(DIS_WIFI)	
#11: WIFI_CONTROL(DIS_WIFI)	
#12: 12VDC	
#13: MDS_2(DIS_DETECT)	
#14: MDS_1(DIS_DETECT)	
#15: 5V_1	

7-5 Wire connecting the indoor unit terminal blocks

1. Terminal press of Ring terminal shall be set facing up before connecting wire.



Is inverted



Terminal has been cut.

2. There shall be no empty space between Ring terminal and Screw after Clamp.

If not, there exists a possibility of fire which can be caused by electric heat in the connecting part.



①



②



③



④



⑤



⑥

①, ② : Good

③ Bad : Ring terminal is connected reversely

④ Bad : Not clamped Screw

⑤ Bad : In the gap between Ring terminal & Screw

⑥ Bad : Unused Ring Terminal

8. Operating Instructions

8-1 Name of Each Part

8-1-1 Indoor Unit

The design and shape are subject to change according to the model.

◆ Main Parts

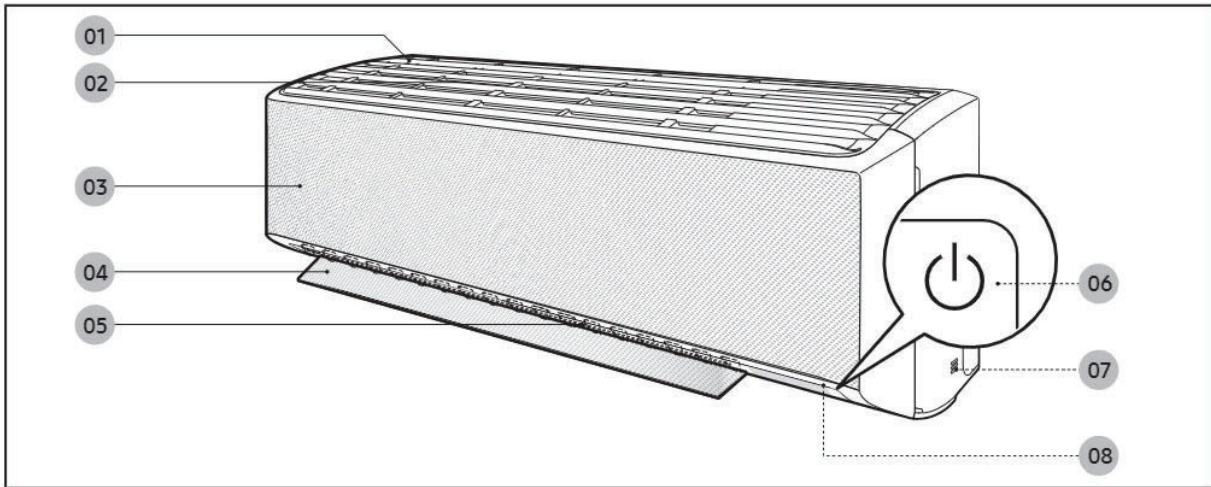

01 Air intake

02 Air filter

03 WindFree panel

04 Airflow blade (up and down)

05 Airflow blade (left and right)

06 Power button/Remote control receiver

07 Room temperature sensor

08 Display

◆ Display

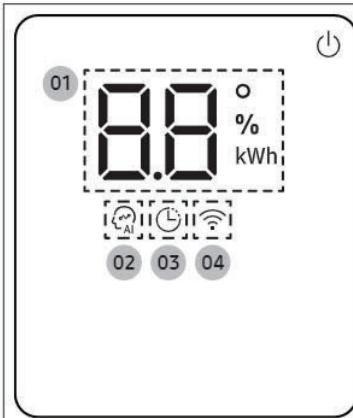

01 Temperature indicator (numeric)
Filter reset indicator (EF)
Electricity consumption indicator (numeric)
Auto clean indicator (C)
Defrost indicator (dF)

02 AI Auto indicator

03 Timer indicator
good'sleep indicator

04 Wi-Fi indicator

NOTE

- When the Wi-Fi is turned on, the indicator blinks three times and then turn on.

8-2 Wireless Remote control-Buttons and Display

DB96-24901B

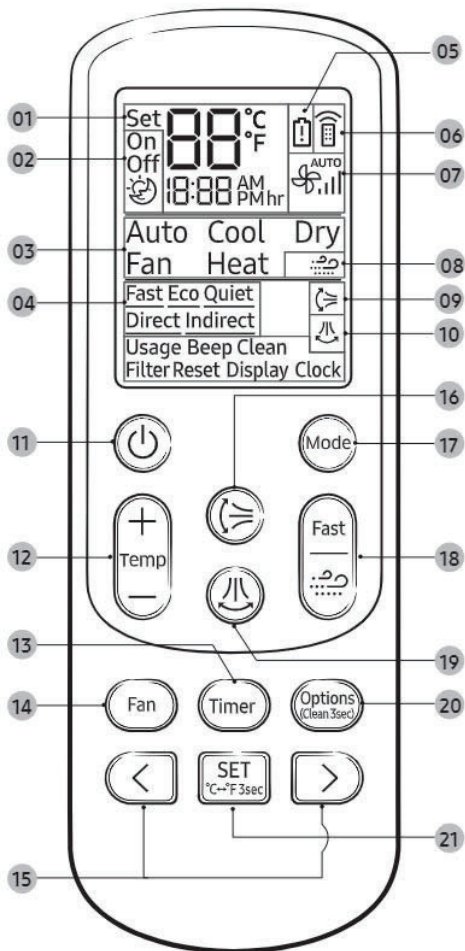

- 01 Set temperature indicator
- 02 Timer option indicator
- 03 Operation mode indicator
- 04 Options indicator
- 05 Low battery indicator
- 06 Transmit indicator
- 07 Fan speed indicator
- 08 WindFree indicator
- 09 Vertical air swing indicator
- 10 Horizontal air swing indicator
- 11 Power button
- 12 Temperature button
- 13 Timer button
- 14 Fan speed button
- 15 Direction button/Selection button
- 16 Vertical air swing button
- 17 Mode button
- 18 Fast/WindFree button
- 19 Horizontal air swing button
- 20 Options/Clean button
- 21 SET button/Temperature type button(°C↔°F)

9. Troubleshooting

9-1 Items to be checked first

- 1 The input voltage should be rating voltage $\pm 10\%$ range. The air conditioner may not operate properly if the voltage is out of this range.
- 2 Is the line cable linking the indoor unit and the outdoor unit linked properly? The indoor unit and the outdoor unit shall be linked by 5 cables. Check the terminals if the indoor unit and outdoor unit are properly linked by the same number of cables. Otherwise the air conditioner may not operate properly.
- 3 When a problem occurs due to the contents illustrated in the table below it is a symptom not related to the malfunction of the air conditioner.

NO.	Operation of air conditioner	Explanation
1	The OPERATION indication LED(BLUE) blinks when a power plug of the indoor unit is plugged in for first time.	It indicates power is on. The LED stops blinking if the operation ON/OFF button on the remote control unit is pushed.
2	In a COOL operation mode, the compressor does not operate at a room temperature higher than the setting temperature that the INDOOR FAN should operate. [In case of heat pump model] In a HEAT operation mode, the compressor does not operate at a room temperature lower than the setting temperature that indoor fan should operate.	In happens after a delay of 3 minutes when the compressor is reoperated. The same phenomenon occurs when a power is on. As a phenomenon that the compressor is reoperated after a delay of 3 minutes, the indoor fan is adjusted automatically with reference to a temperature of the air blew.
3	Fan speed setting is not allowed in DRY mode.	The speed of the indoor fan is set to LL in DRY mode. Fan speed is selected automatically in AUTO mode.
4	Compressor stops operation intermittently in Dry mode.	Compressor operation is controlled automatically in DRY mode depending on the room temperature and humidity.
5	Timer LED(ORANGE) of the indoor unit lights up and the air conditioner does not operate.	Timer is being activated and the unit is in ready mode. The unit operates normally if the timer operation is cancelled.
6	The compressor stops intermittently in a COOL mode or DRY mode, and fan speed of the indoor unit decreases.	The compressor stops intermittently or the fan speed of the indoor unit decreases to prevent inside/outside air frozen depending on the inside/outside air temperature.
7	[In case of heat pump model] Compressor of the outdoor unit is operating although it is turned off in a HEAT mode.	When the unit is turned off while de-ice is activated, the compressor continues operation for up to 9 minutes(maximum) until the deice is completed.
8	[In case of heat pump model] The compressor and indoor fan stop intermittently in HEAT mode.	The compressor and indoor fan stop intermittently if room temperature exceeds a setting temperature in order to protect the compressor from overheated air in a HEAT mode.
9	[In case of heat pump model] Indoor fan and outdoor fan stop operation intermittently in a HEAT mode.	The compressor operates in a reverse cycle to remove exterior ice in a HEAT mode, and indoor fan and outdoor fan do not operate intermittently for within 20% of the total heater operation.

9-2 Communication Error

9-2-1 Communication Error

Indoor display

7-SEG DISPLAY	DESCRIPTION
C101/C102	Communication error(Indoor<->outdoor)

Outdoor display

●	●	●	1min. Time out Comm.
○	○	●	Abnormal Communication
○	●	●	

● LED ON ◐ LED BLINKING ○ LED OFF

1. Checklist :

- 1) Is the cable between the indoor unit and outdoor unit connected correctly?
- 2) Isn't the power cable and communication cable cross?

2. Troubleshooting procedure

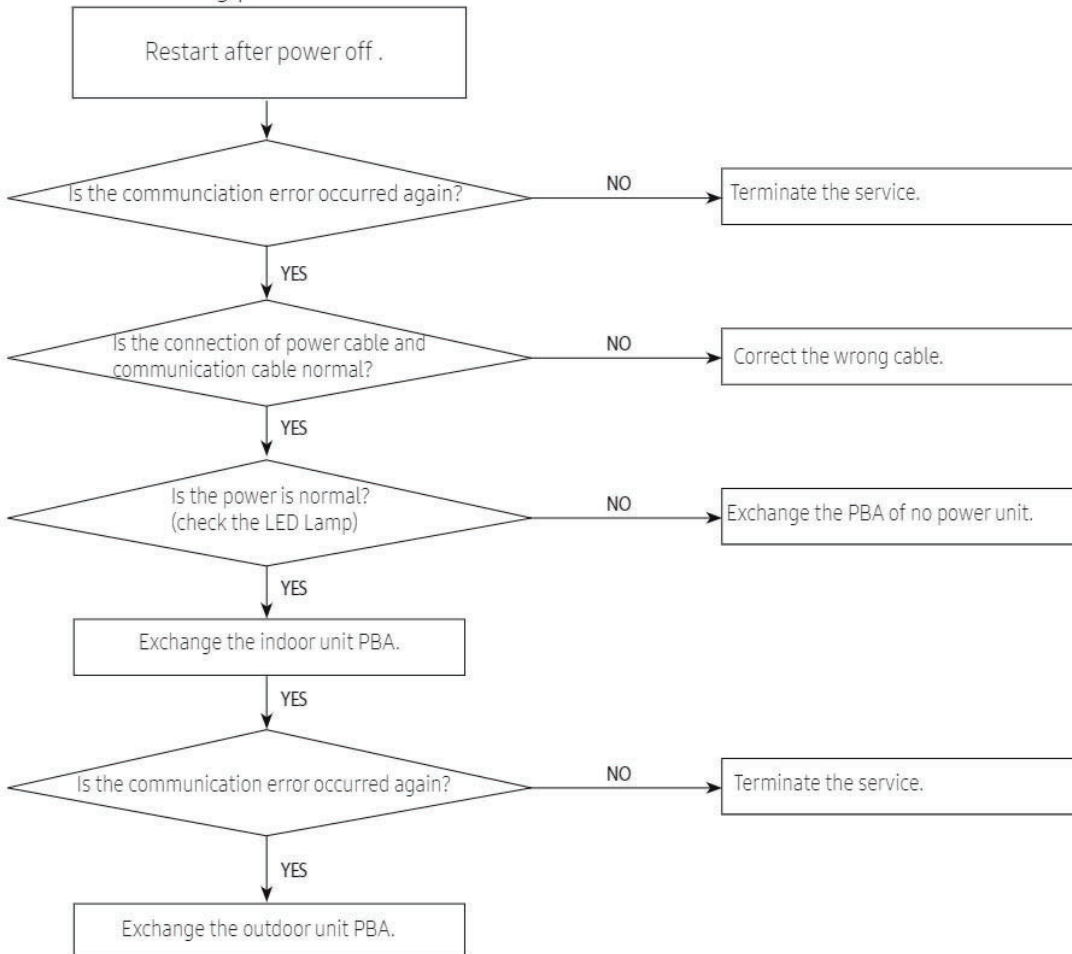

9-2-2 Indoor temperature sensor Error

Indoor display

7-SEG DISPLAY	DESCRIPTION
C121	Indoor room temp sensor error

● LED ON ◐ LED BLINKING ○ LED OFF

1. Checklist :

- 1) Is the indoor units temperature sensor connected correctly?
- 2) Is the sensor placed correctly?
- 3) Does the both terminal of sensor satisfy the resistance value in accordance with temperature?

2. Troubleshooting procedure

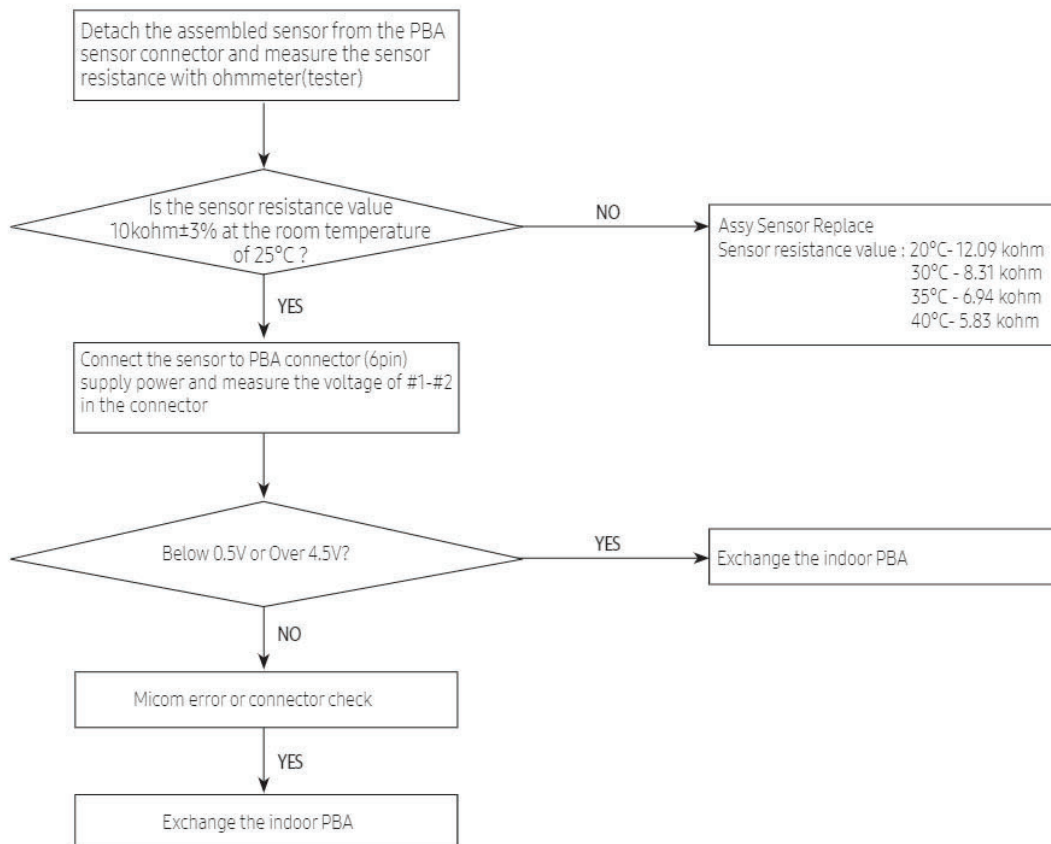

9-2-3 Indoor fan motor speed detecting error (BLDC fan)

Indoor display

7-SEG DISPLAY	DESCRIPTION
C154	Indoor fan error

● LED ON ◐ LED BLINKING ○ LED OFF

1. Checklist :

- 1) Is the indoor units fan motor properly connected with the connector(CN72)?
- 2) Is the AC voltage correct?

2. Troubleshooting procedure

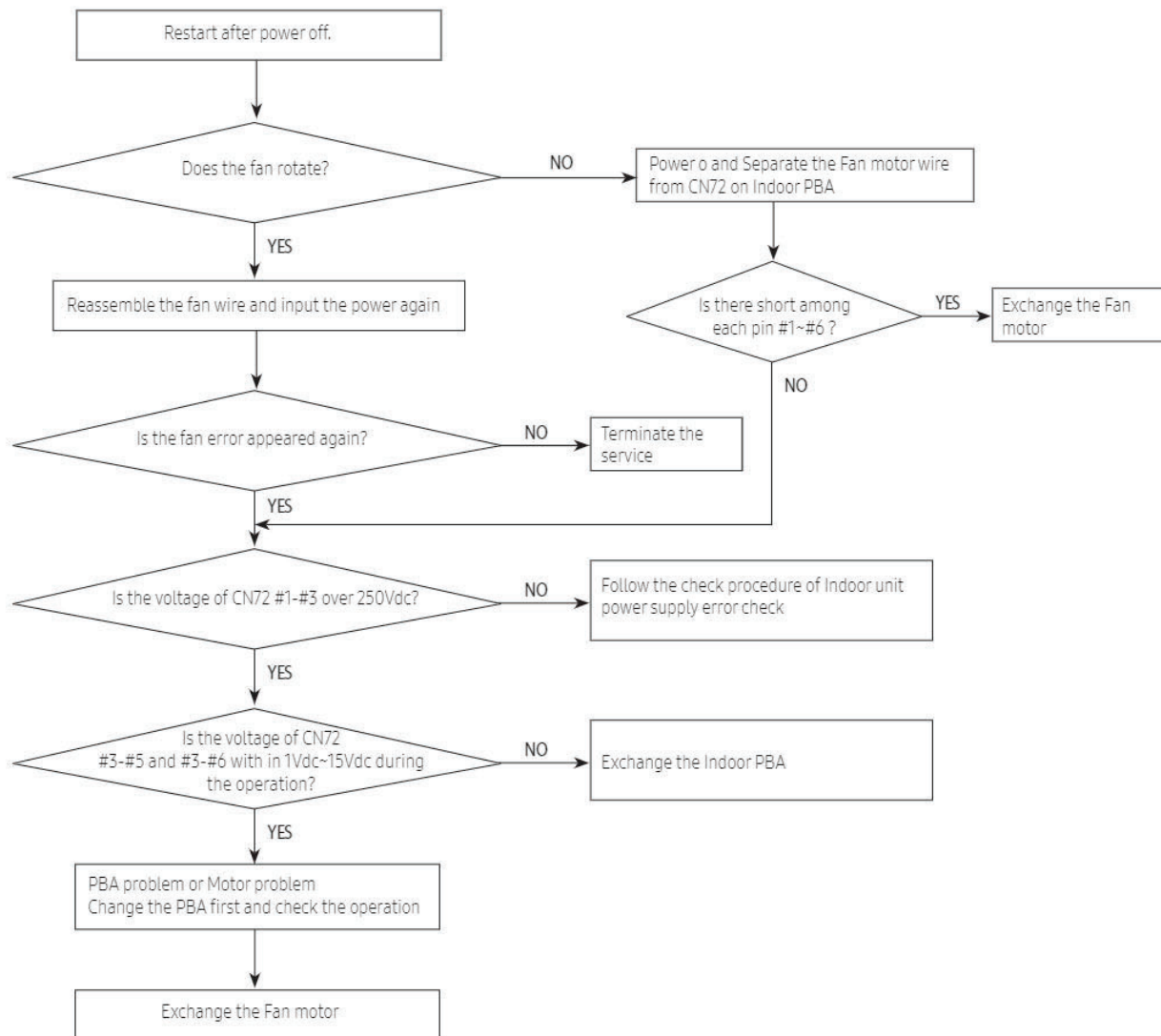

9-2-4 Outdoor temperature sensor error

Indoor display

7-SEG DISPLAY	DESCRIPTION
C221	Outdoor temperature sensor error

Outdoor display

●	◐	◑	Outdoor temperature sensor error
---	---	---	----------------------------------

● LED ON ◐ LED BLINKING ◑ LED OFF

1. Checklist :

- 1) Is the sensor connected correctly?
- 2) Is the sensor placed correctly?
- 3) Does the both terminal of sensor satisfy the resistance value in accordance with temperature?
- 4) Is the resistance value of sensor connection pull-up correct?

2. Troubleshooting procedure

Model	"A"	"B"
ALL	CN251	CN251 #1-#2

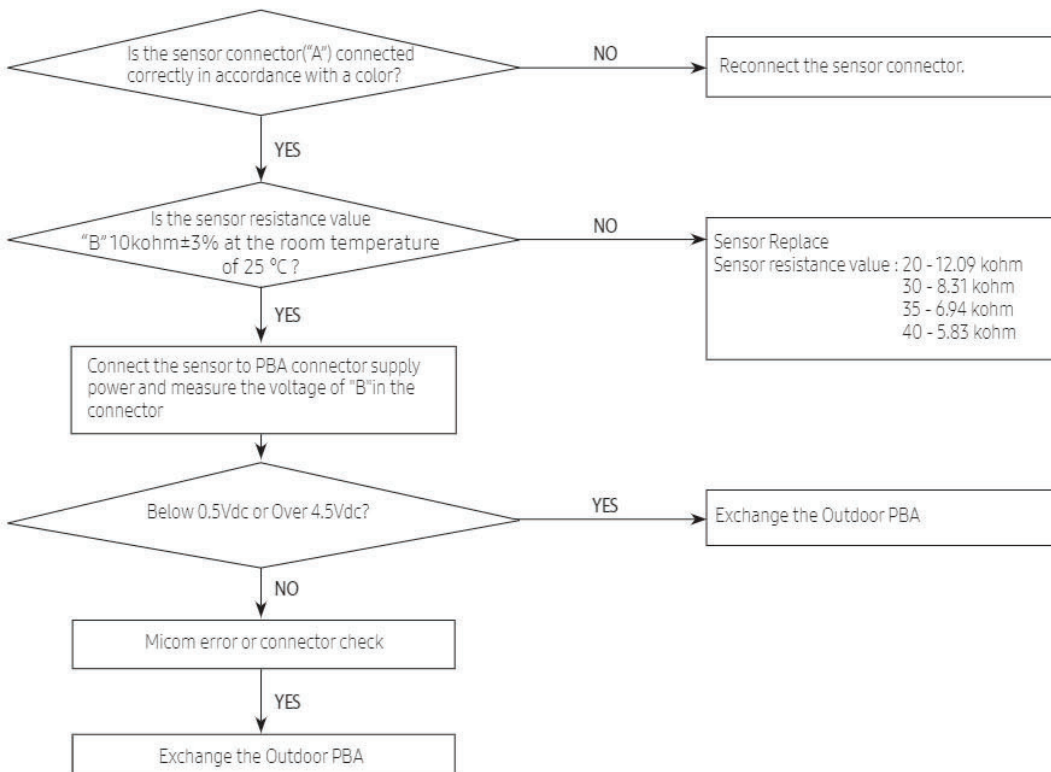

9-2-5 Outdoor Cond temperature sensor error

Indoor display

7-SEG DISPLAY	DESCRIPTION
C231	Outdoor Cond temperature sensor error

Outdoor display

●	●	●	Outdoor Cond temperature sensor error
---	---	---	---------------------------------------

● LED ON ● LED BLINKING ○ LED OFF

1. Checklist :

- 1) Is the sensor connected correctly?
- 2) Is the sensor placed correctly?
- 3) Does the both terminal of sensor satisfy the resistance value in accordance with temperature?
- 4) Is the resistance value of sensor connection pull-up correct?

2. Troubleshooting procedure

Model	"A"	"B"
ALL	CN251	CN251 #5-#6

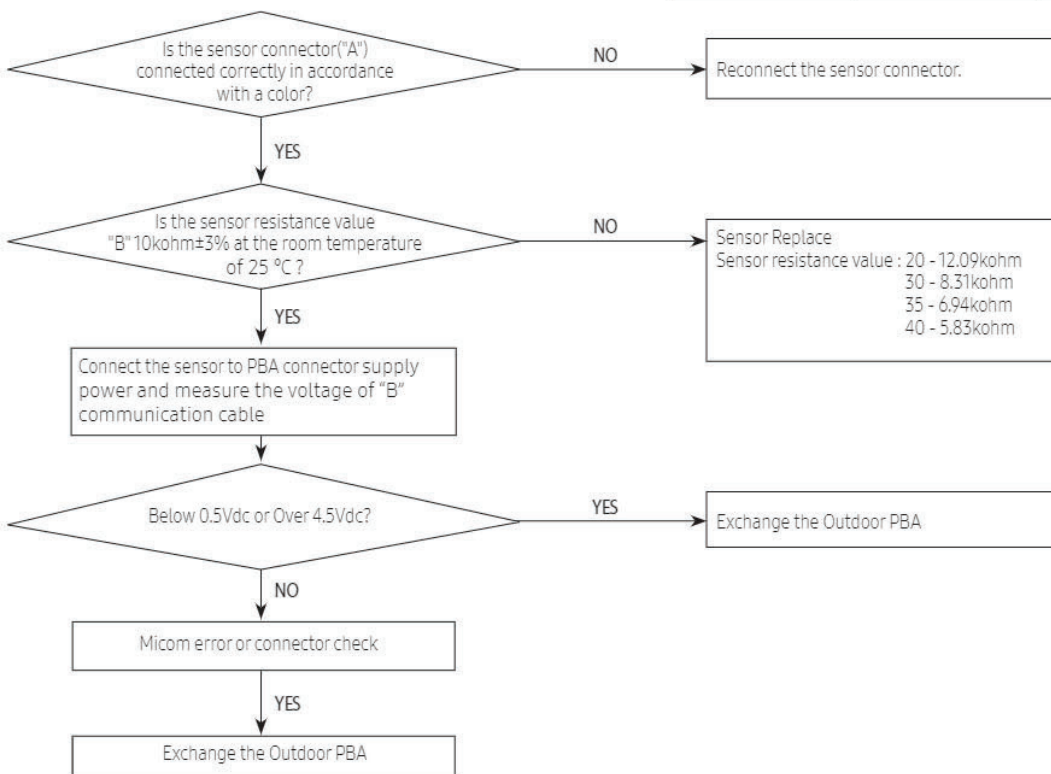

9-2-6 Outdoor Discharge temperature sensor error

Indoor display

7-SEG DISPLAY	DESCRIPTION
C251	Outdoor Discharge temperature sensor error

Outdoor display

●	◐	○	Outdoor Discharge temperature sensor error
---	---	---	--

● LED ON ◐ LED BLINKING ○ LED OFF

1. Checklist :

- 1) Is the sensor connected correctly?
- 2) Is the sensor placed correctly?
- 3) Does the both terminal of sensor satisfy the resistance value in accordance with temperature?
- 4) Is the resistance value of sensor connection pull-up correct?

2. Troubleshooting procedure

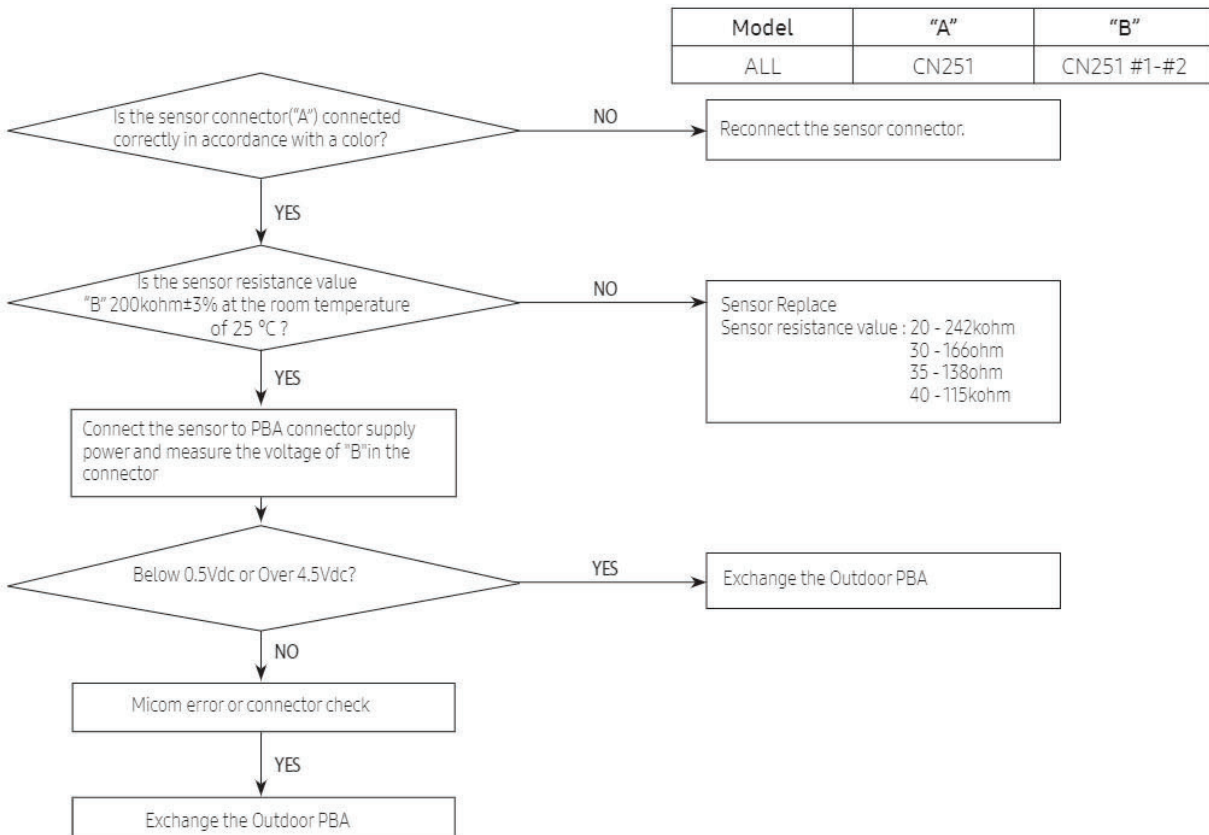

9-2-7 Operation condition secession error

Indoor display

7-SEG DISPLAY	DESCRIPTION
C440	Prohibit Operation Condition Error (Heating)
C441	Prohibit Operation Condition Error (Cooling)

Outdoor display

●	◐	○	Operation condition secession
---	---	---	-------------------------------

● LED ON ◐ LED BLINKING ○ LED OFF

1. Checklist :

- 1) Check the temperature around the outdoor unit.

2. Troubleshooting procedure

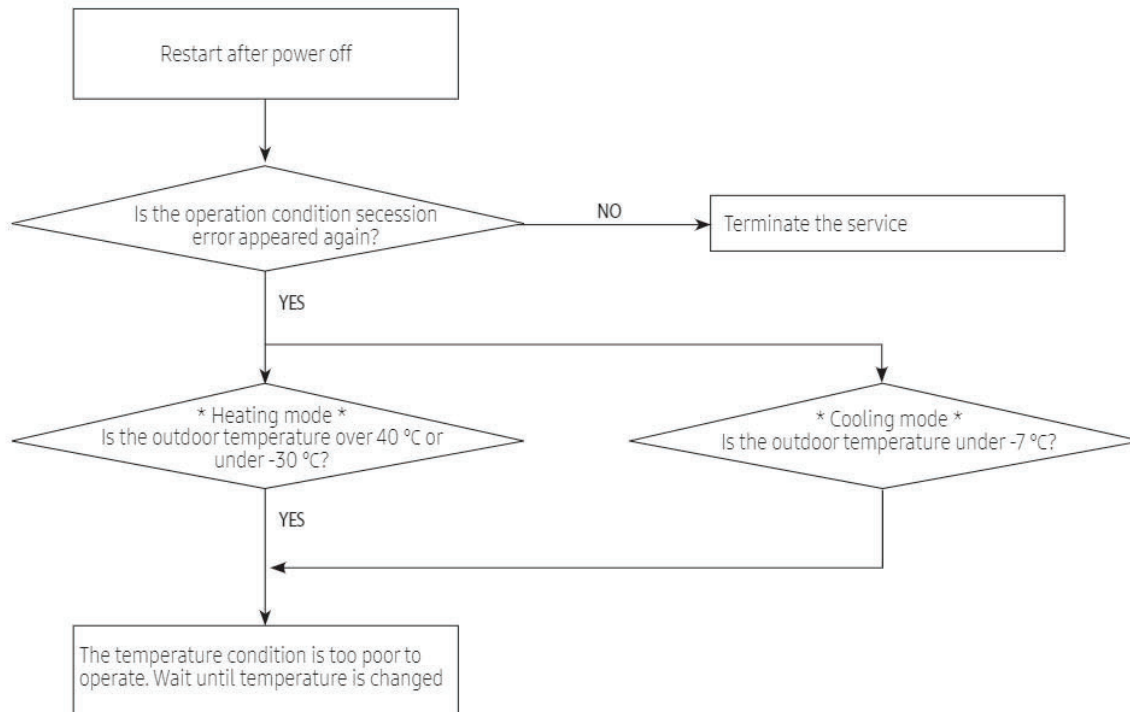

9-2-8 EEPROM error / OTP error

Indoor display

7-SEG DISPLAY	DESCRIPTION
C470	EEPROM Data Error (no data)
C471	OTP error EEPROM Data Error (Main Micom Inv Micom)

Outdoor display

○	●	○	EEPROM Data Error (no data)
●	○	◎	OTP error EEPROM Data Error (Main Micom Inv Micom)

● LED ON ◐ LED BLINKING ○ LED OFF

1. Checklist :

- 1) Is there a short around micom?
- 2) Is there a short around "A"?
- 3) Did you download or insert EEPROM IC, after changing outdoor PBA?

2. Troubleshooting procedure

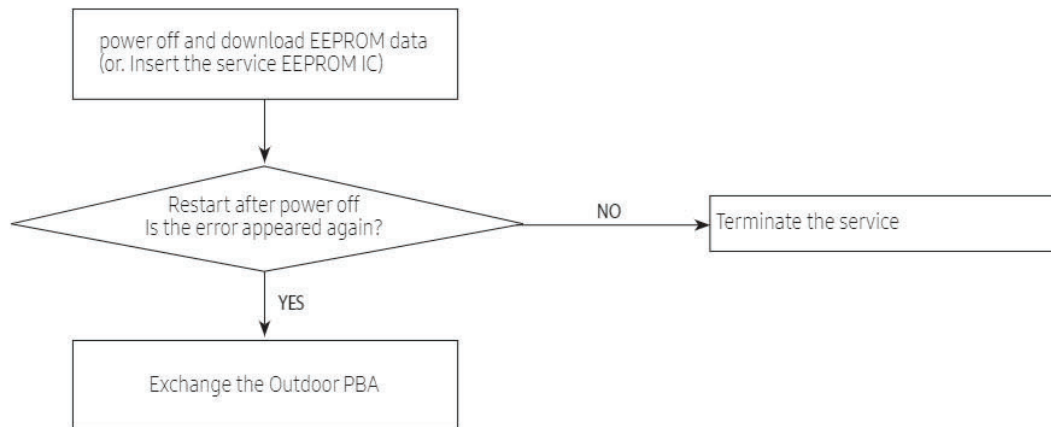

9-2-9 Outdoor Fan motor error

Indoor display

7-SEG DISPLAY	DESCRIPTION
C458	Outdoor fan error

Outdoor display

●	◐	○	Outdoor fan error
---	---	---	-------------------

● LED ON ◐ LED BLINKING ○ LED OFF

1. Checklist :

- 1) Are the input power voltage and the power connection correct?
- 2) Is the motor wire connected to the outdoor PBA correctly?
- 3) Is there no assembly error or non-assembly in the terminal of motor wire connector?
- 4) Is there no obstacle at the surrounding of motor and propeller?

2. Troubleshooting procedure

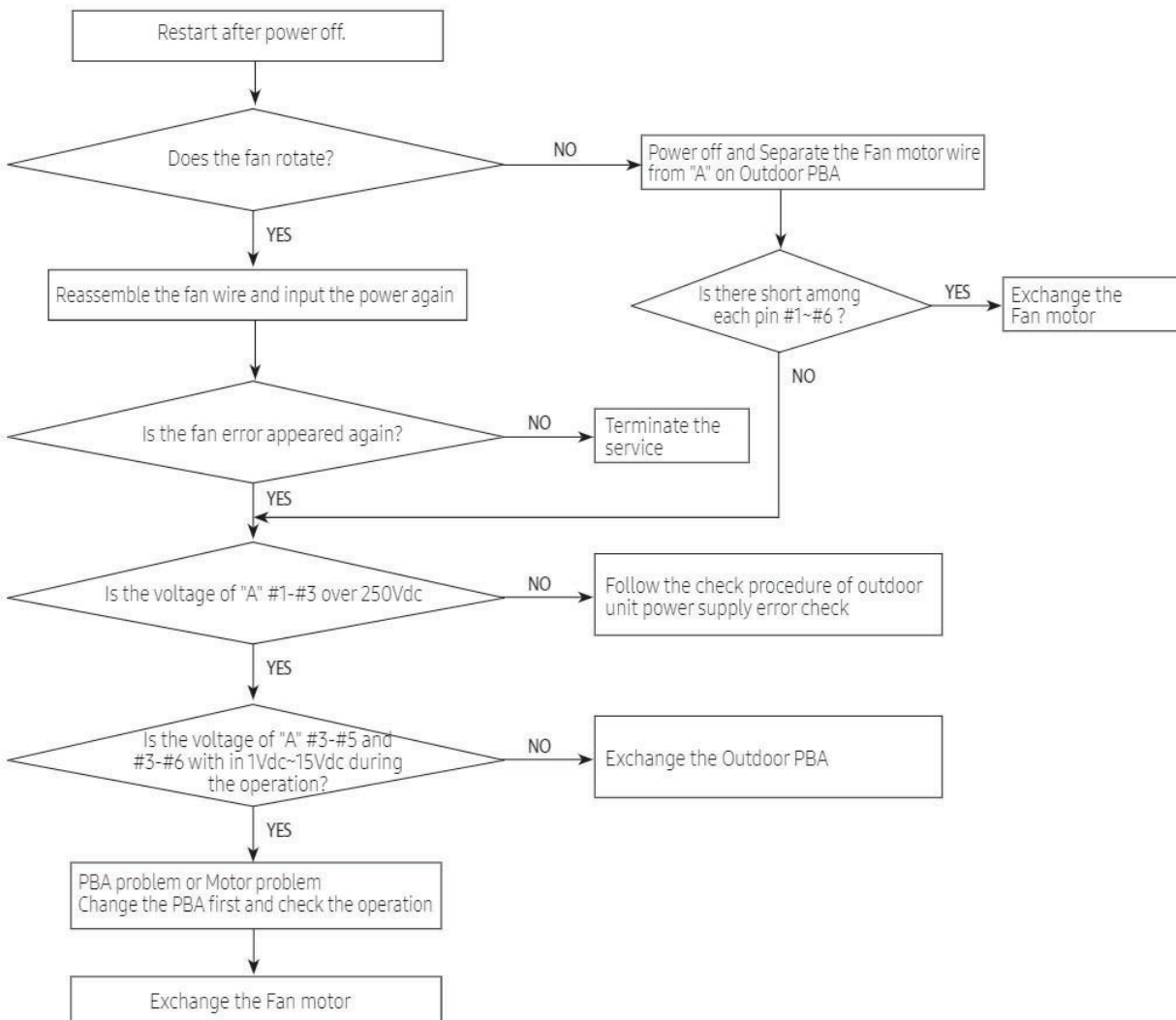

9-2-10 Compressor starting error

Indoor display

7-SEG DISPLAY	DESCRIPTION
C461	Comp starting error

Outdoor display

○	◐	○	Comp starting error
---	---	---	---------------------

● LED ON ◐ LED BLINKING ○ LED OFF

1. Checklist :

- 1) Is the connection of cable for the compressor?
- 2) Is the compressor wire is connected clockwise? U(RED)-V(BLU)-W(YEL)
- 3) Is the interphase resistance of compressor normal?

2. Troubleshooting procedure

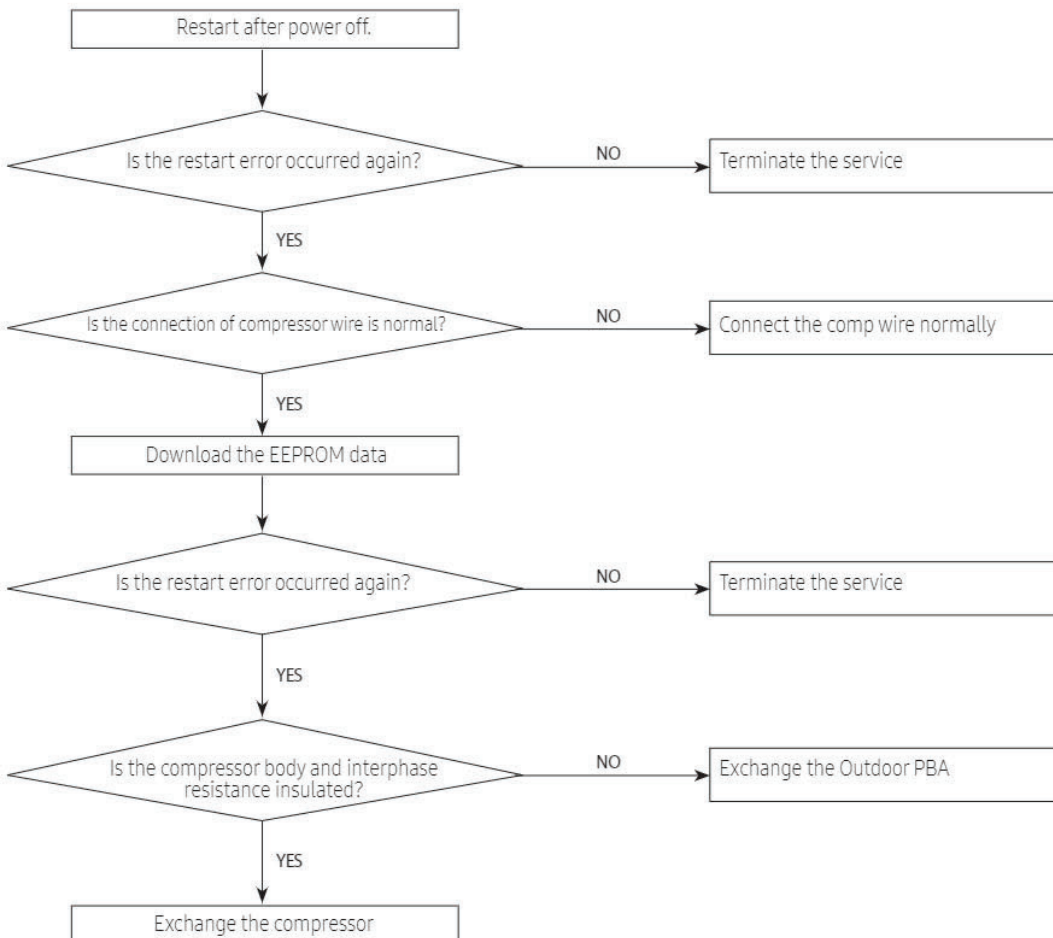

9-2-11 Compressor wire missing error/rotation error

Indoor display

7-SEG DISPLAY	DESCRIPTION
C467	Compressor wire missing error/rotation error

Outdoor display

●	○	●	Compressor wire missing error/rotation error
---	---	---	--

● LED ON ◐ LED BLINKING ○ LED OFF

1. Checklist :

- 1) Is the connection of cable for the compressor?
- 2) Is the compressor wire is connected clockwise? U(RED)-V(BLU)-W(YEL)
- 3) Is the interphase resistance of compressor normal?

2. Troubleshooting procedure

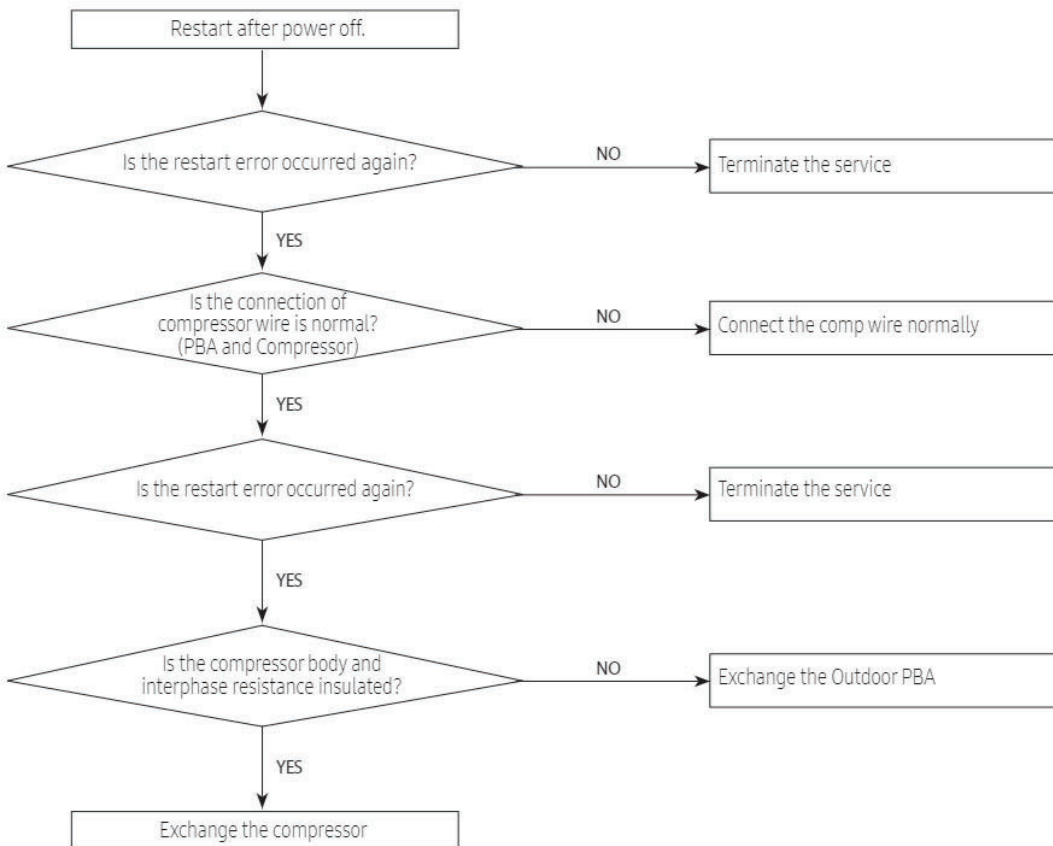

9-2-12 Current sensor error/Input current sensor error

Indoor display

7-SEG DISPLAY	DESCRIPTION
C462	AC Input I_Limit Trip Error

Outdoor display

●	◎	●	Current sensor error
			Input current sensor error

● LED ON ◎ LED BLINKING ○ LED OFF

1. Checklist :

- 1) Is the PFC Shunt("A") resistance value correct? Check the resistor is opened
- 2) Is the IPM Shunt("B") resistance value correct? Check the resistor is opened
- 3) Is there no short or open around "C"?

2. Troubleshooting procedure

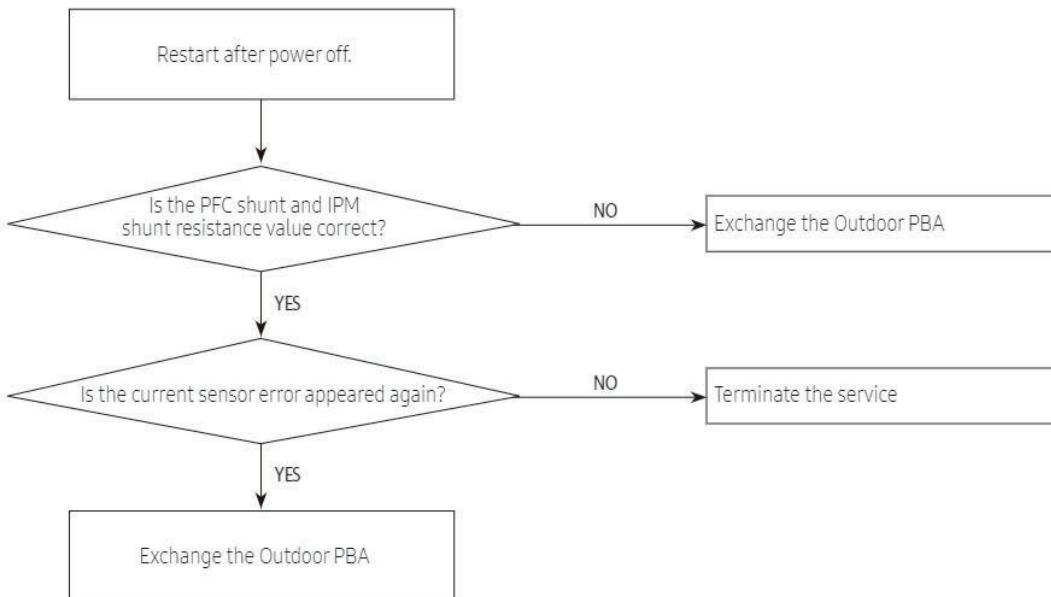

9-2-13 O.C(Over Current) error

Indoor display

7-SEG DISPLAY	DESCRIPTION
C464	IPM Over Current(O.C) Error

Outdoor display

○	○	◎	Current sensor error
---	---	---	----------------------

● LED ON ◐ LED BLINKING ○ LED OFF

1. Checklist :

- 1) Is the IPM Shunt resistance value correct? Check the resistor is opened
- 2) Is the condition of surrounding temperature abnormal overload?
- 3) Is there any problem as like the temperature sensor separation or measurement value error?
- 4) Is the interphase resistance of compressor normal?

2. Troubleshooting procedure

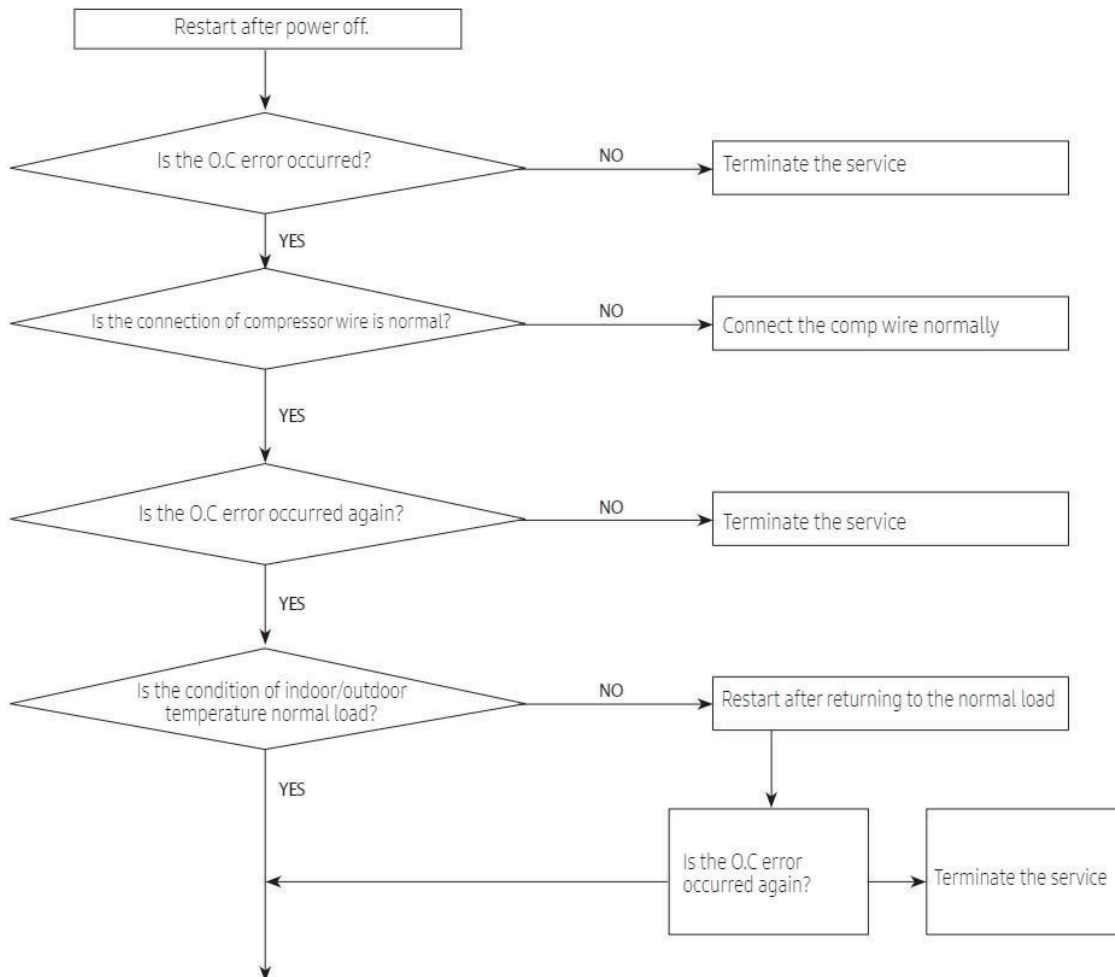

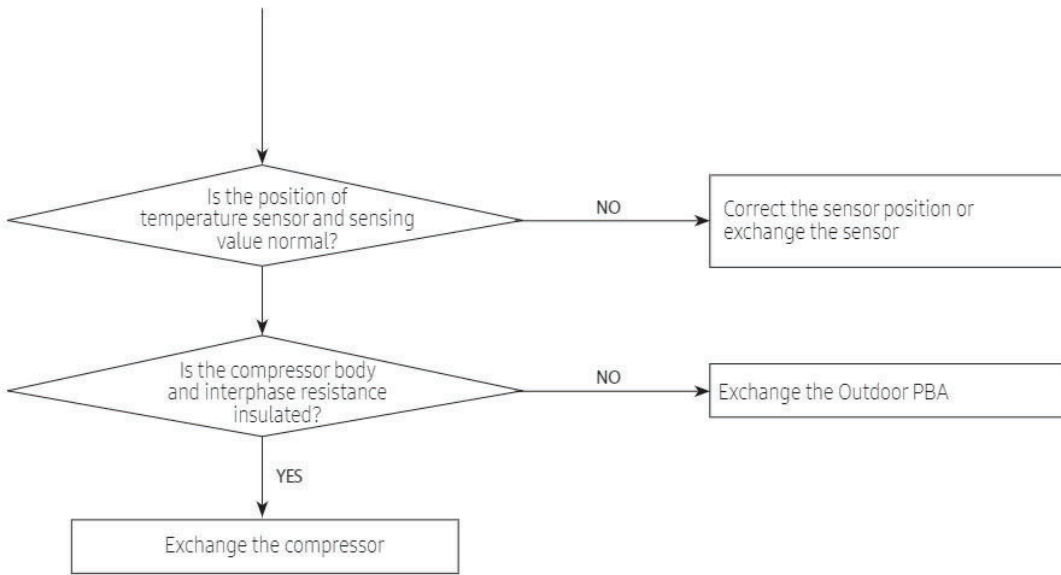

9-2-14 No power outdoor (Initial Diagnosis) (Not displayed)

1. Checklist :

- 1) Is input power normal?
- 2) Is AC power linked correctly? (L,N,E)
- 3) Is mis-wiring between communication wire and Power wire?
- 4) Is mis-wiring between Main PBA and SMPS PBA wire?
- 5) Is input voltage of SMPS AC in Main PBA (CN150) normal?
- 6) Is the voltage of SMPS DC in Main PBA (CN151,CN152) normal?

2. Troubleshooting procedure

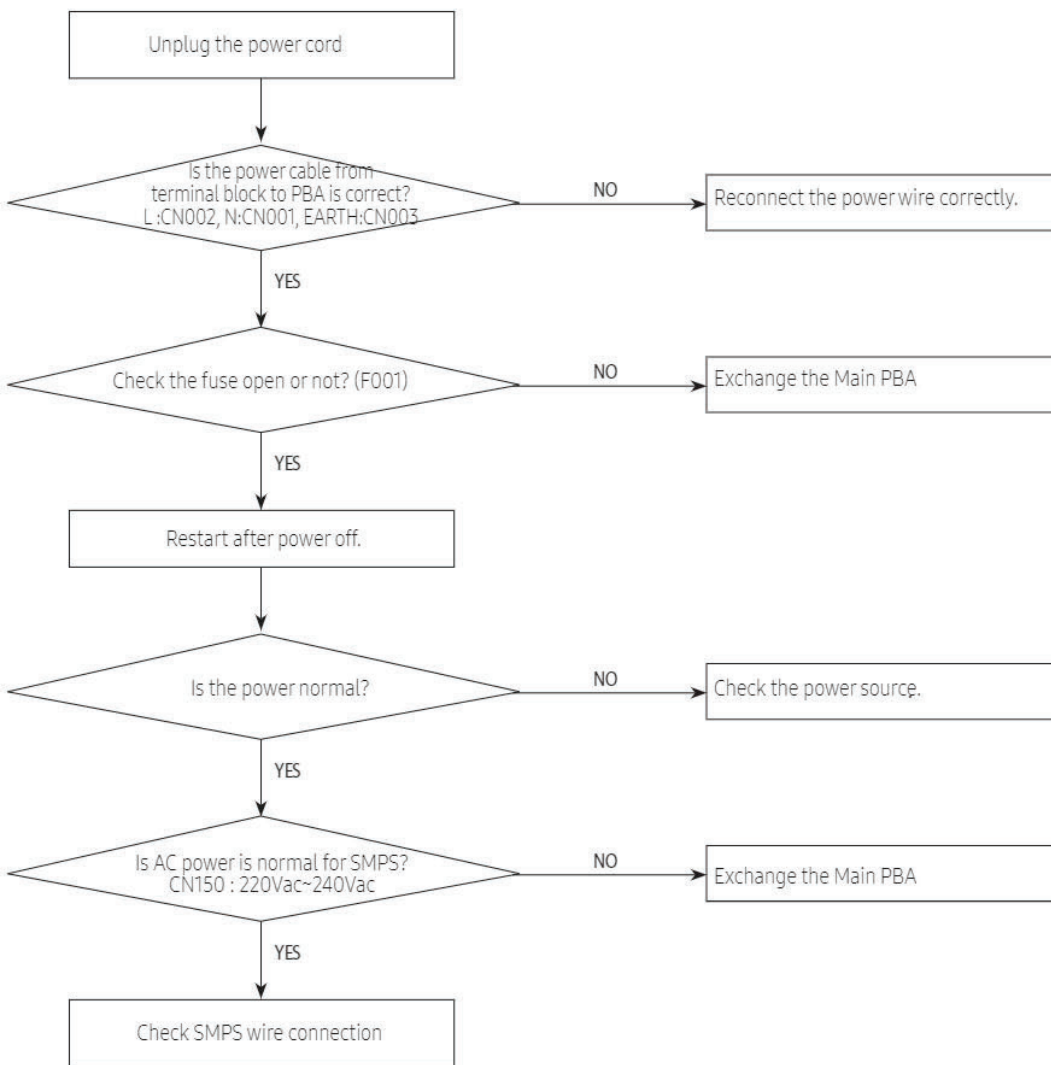

9-2-15 When the Up/Down, Left/Right, Grill louver motor does not operate (Initial Diagnosis) (Not displayed)

1. Checklist :

- 1) Is the input power voltage normal?
- 2) Is the Up/Down louver motor properly connected with the connector? (CN61, CN62, CN63)

2. Troubleshooting procedure

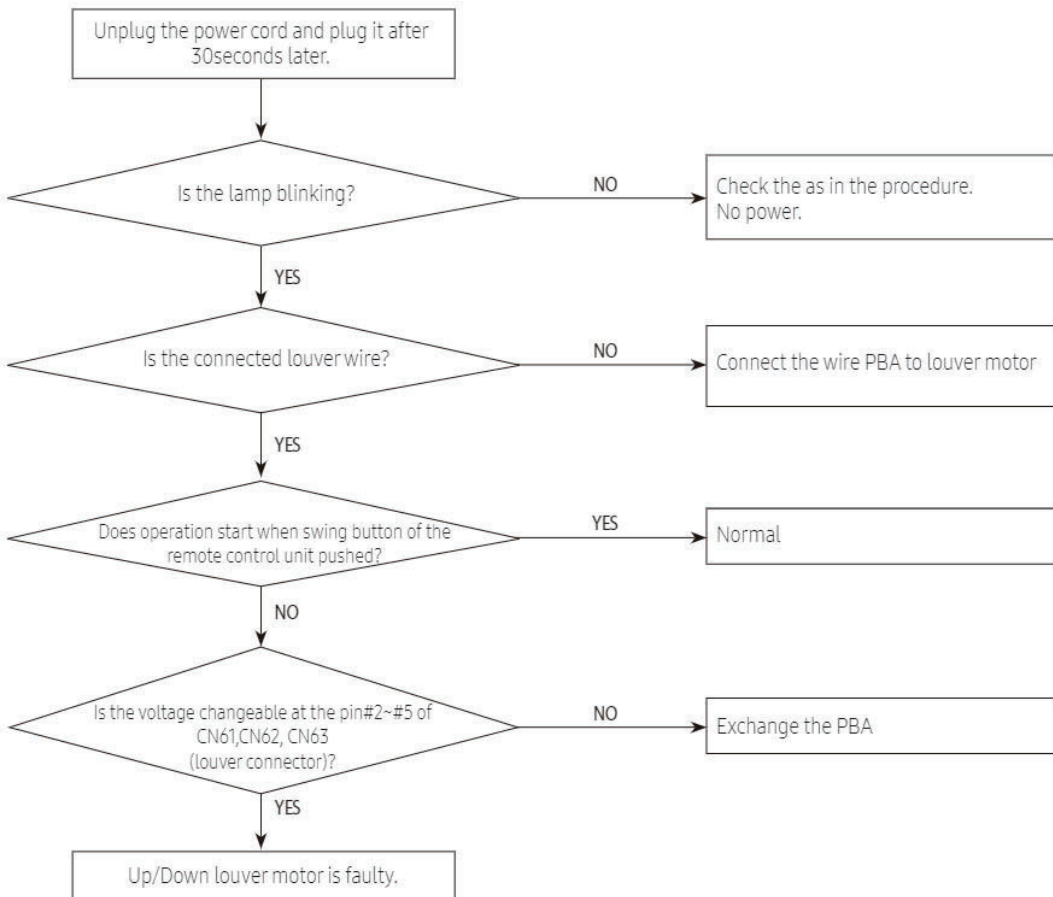

9-2-16 When the remote control is not receiving

1. Checklist :

- 1) Check if the connector was normally assembled.
- 2) Check the battery in remote control
- 3) All the lights out and check again : Change electronic typed to a rescent light
- 4) Put the set in operation and check the voltage of display PBA
- 5) Replace the display PBA

2. Troubleshooting procedure

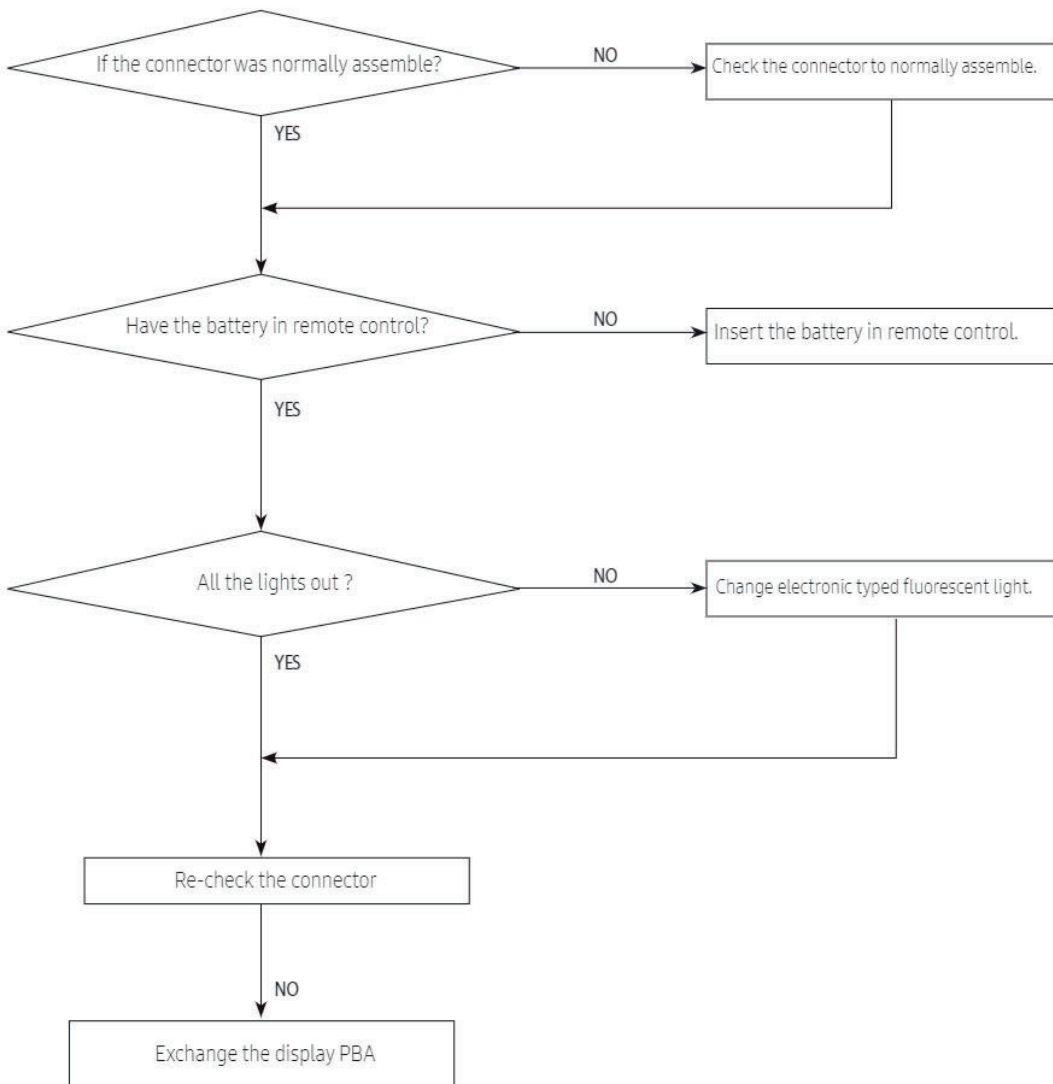

9-2-17 Smart Install error

1. Checklist :

- 1) Check the leakage region.(Use leakage detection liquid or soapy water)
- 2) When leakage region is found from service valve and piping connection re nut part : After the related measures to check the refrigerant supplements and operation.
- 3) If the leakage region is pipe welding part : Weld leakage region after refrigerant gas release.(Brass parts should only apply)
- 4) If the leakage region is surface area (Heat exchanger or pipe welding region is not) : Replace parts.
- 5) Check the PBA Relay
 - Display of indoor unit : Ensure that the operating pilot lamp has been lighted.
 - Ensure that the Relay input voltage of indoor unit PBA is normally.(If the PBA is defective, replace)

2. When the air conditioner is in standby status, use the remote controller to start the Smart Install mode.

- 1) Press the [SET], [Mode], [Power] button simultaneously for 4 seconds.
 - Smart Install mode can be operated only with the supplied remote controller.
 - During the Smart install mode procedure, remote controller cannot be operated.

3. Troubleshooting procedure

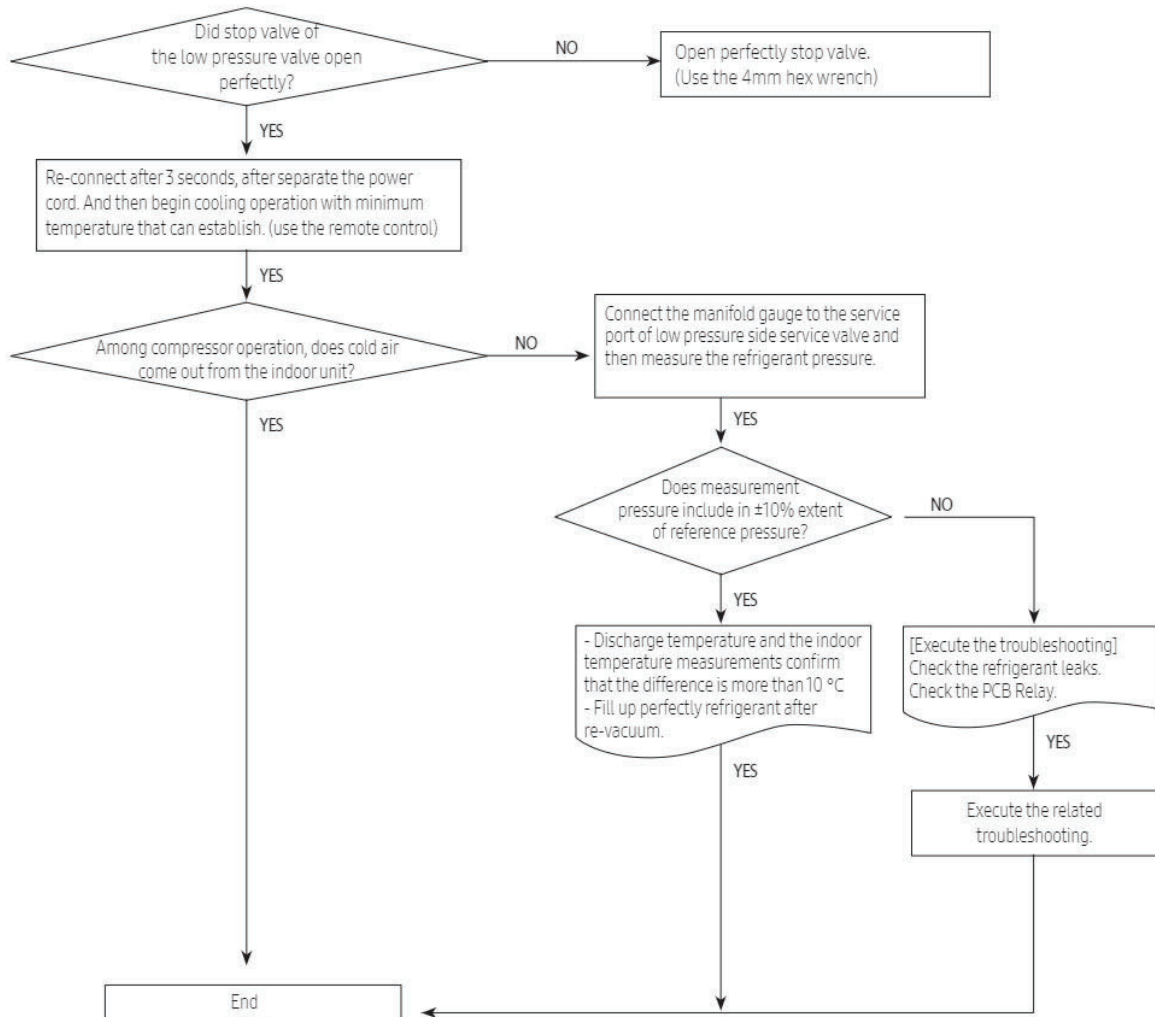

9-2-18 Outdoor OLP over temperature error (One way Inverter Only)

Indoor display

DESCRIPTION
No display about the outdoor condition

Outdoor display

◎	○	●	C463	IPM Over Current(O.C) Error
---	---	---	------	-----------------------------

● LED ON ◐ LED BLINKING ○ LED OFF

1. Checklist :

- 1) Is the sensor placed correctly?
- 2) Check the service valve is closed
- 3) Check the compressor locking or gas leak

2. Troubleshooting procedure

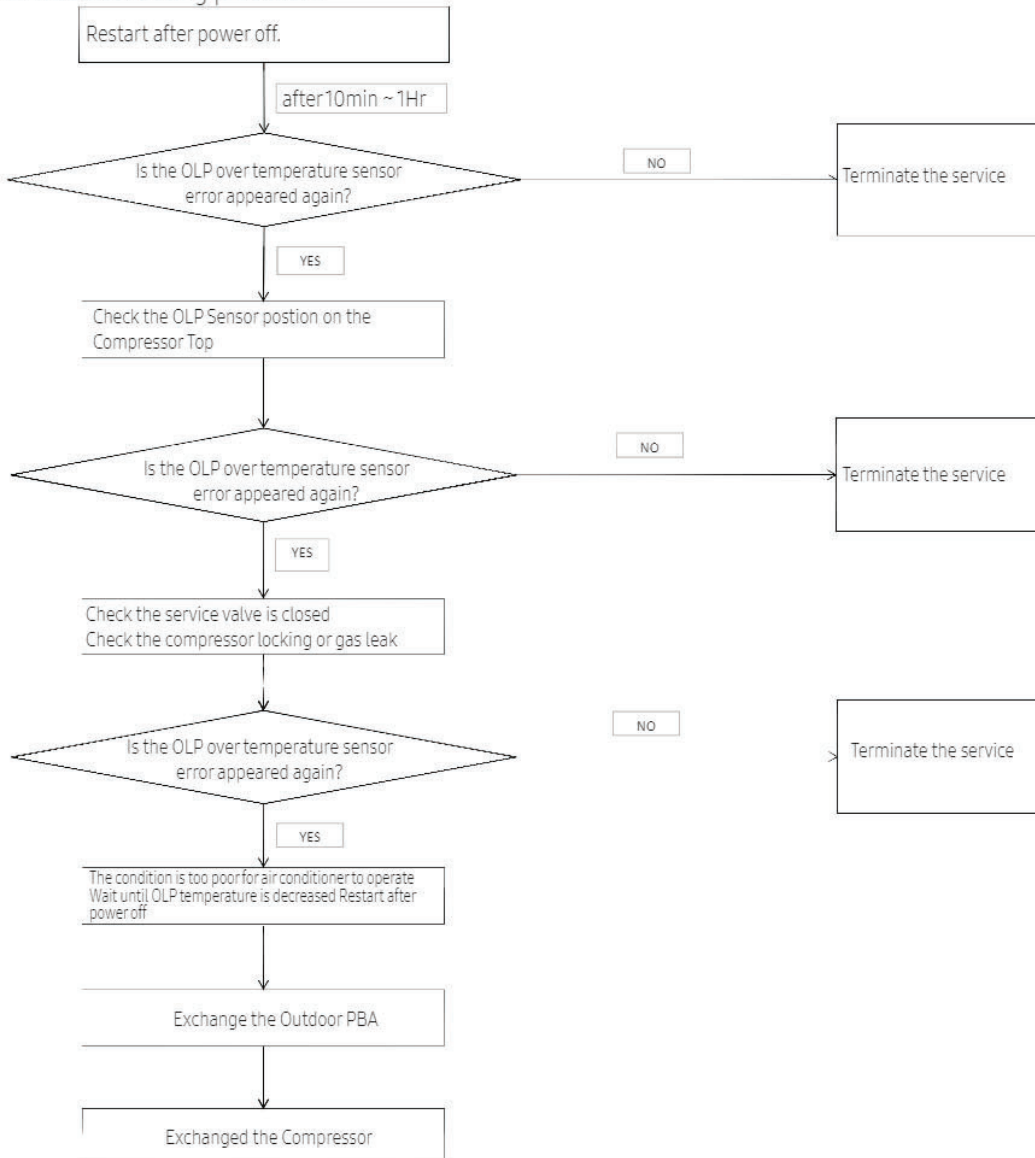

9-2-19 EEV or VALVE CLOSE error (C422)

1. failure cause

- 1) Check for leakage using leakage detection liquid or soapy water.
- 2) If a leak is found in the service valve or piping connection flare nut part, take the relevant action and recheck the refrigerant and operation.
- 3) If the leakage part is a PIPE welding part, rewelding is performed after release of refrigerant gas to block the leakage part.
- 4) If the leakage part is found on the surface other than the heat exchanger or PIPE welding part, replace the part
- 5) PBA Check
 - Check if an error has occurred in the indoor Display.
 - Check if the input voltage of the indoor PBA is normal and replace the PBA if there is any abnormality.

2. Troubleshooting procedure

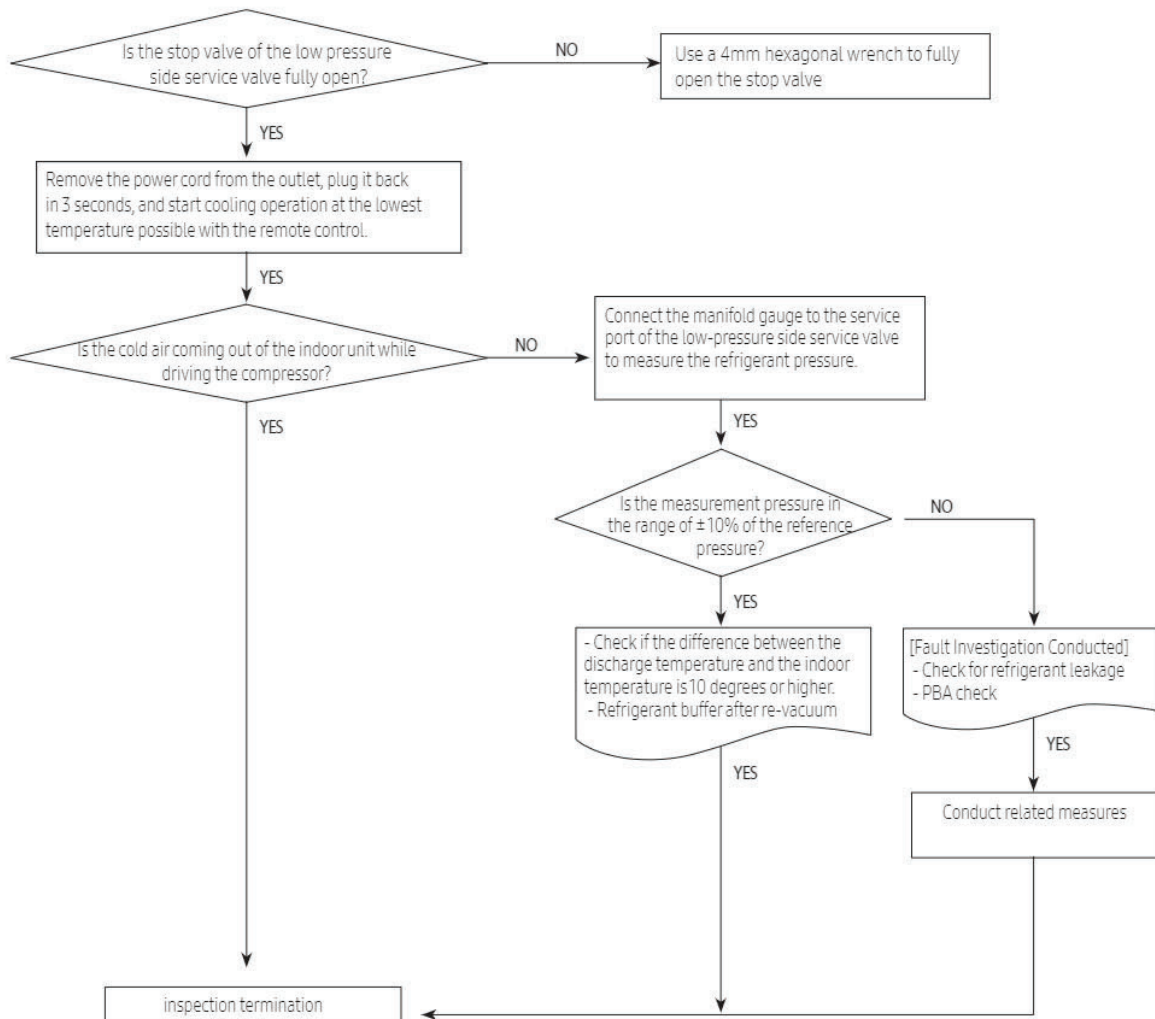

10. Block Diagram

10-1 Indoor unit

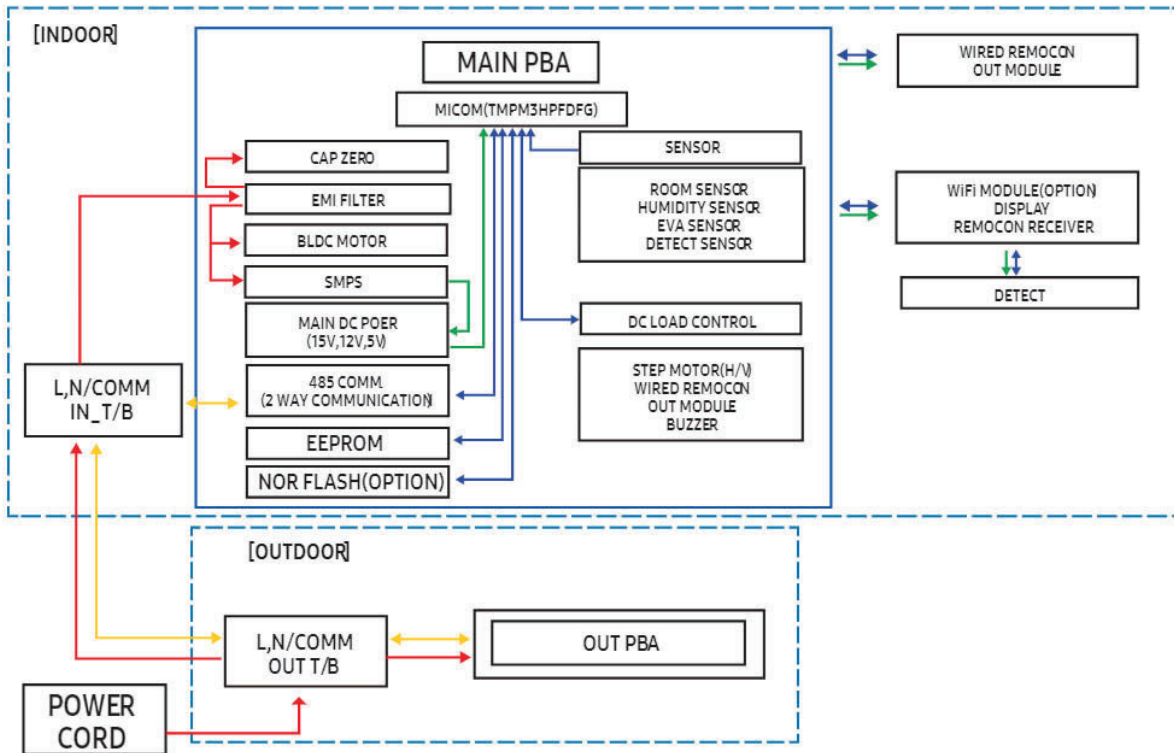

10-2 Outdoor unit

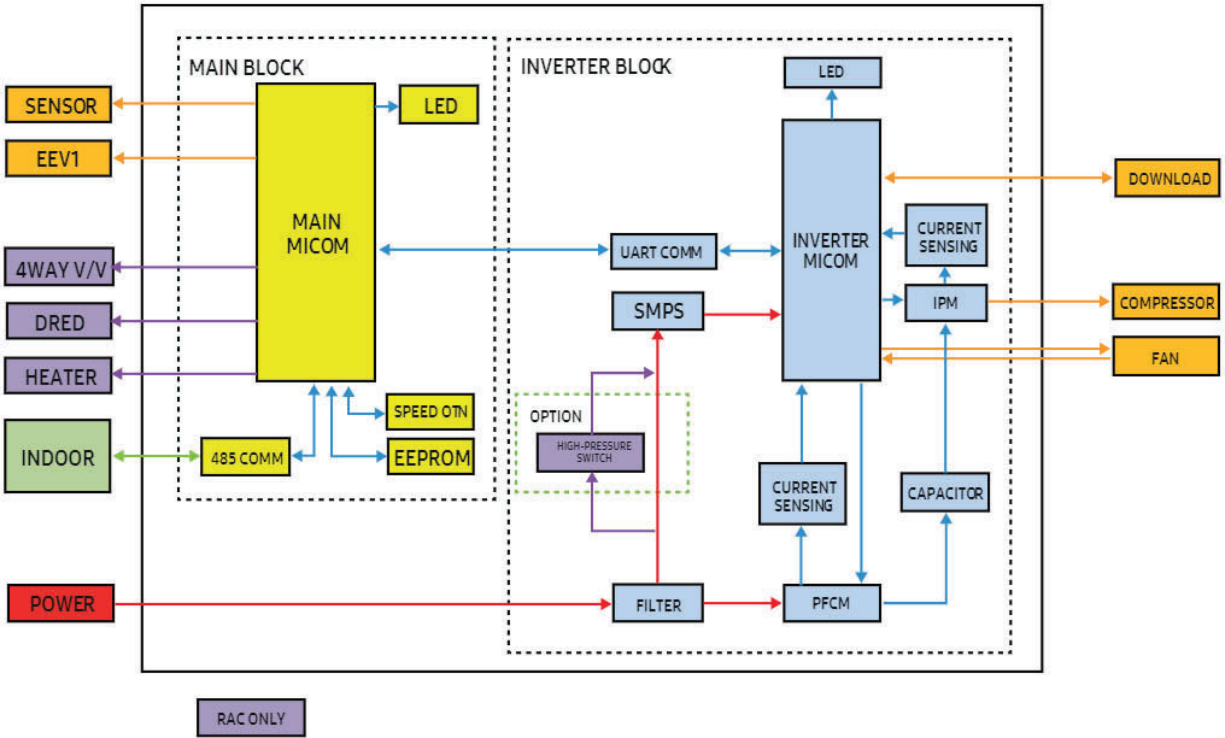

10-2-1 Pre-inspection Notices

- 1 Check if you pulled out the AC power plug when you eliminate the PCB or front panel.
- 2 Don't hold the PCB side not impose excessive force on it to eliminate the PCB.
- 3 Don't pull the lead wire but hold the whole housing to connect or disconnect a connector to the PCB.
- 4 In case of outdoor PCB disassembly, check first the complete discharge of condenser after 1 minute power off.

10-2-2 Inspection procedure

- 1 Check connector connection and peeling of PCB or bronze coating pattern when you think the PCB is broken.
- 2 The PCB is composed of 3 parts.
 - Indoor Main part : MICOM and surrounding circuit, relay, fan motor sensing and driving circuit, temperature sensing circuit power circuit of SMPS, buzzer circuit. Communication circuit.
 - Display part : LED lamp, Switch, Remote-control module.
 - Outdoor Main part : MICOM and surround circuit, fan motor sensing and driving circuit, compressor driving circuit power circuit of SMPS, PFC control circuit, 4way circuit, communication circuit, OPTION (EEV control circuit, temperature sensing circuit).

10-2-3 Indoor detailed inspection procedure

No.	Procedure	Inspection Method	Cause
1	Plug out and pull the PCB out of the control box Check the PCB fuse	1) Is 1st fuse disconnected? 2) Is 2nd fuse disconnected?	<ul style="list-style-type: none"> • Over current • Indoor Fan motor short • AC part and pattern short of Indoor PBA
2	Supply power If the operating lamp twinkles at this time , the above 1)~3) have no relation	Check the power voltage	
		1) Is the BD71 input voltage 200Vac~240Vac?	<ul style="list-style-type: none"> • Power cord is fault, Fuse open, Wrong Power cable Wiring, AC part is faulty
		2) Is the voltage between both terminal of IC02 pin #1-#2 12Vdc?	<ul style="list-style-type: none"> • Switching Trans of Power circuit is faulty
3	Press the ON/OFF button 1. Fan speed(high) 2. Continuous Operation	3) Is the voltage between both terminal of IC02 pin #2-#3 5Vdc?	<ul style="list-style-type: none"> • Power circuit is faulty, Load short
		1) Is the voltage over AC 180V being imposed on terminal #3-#5 of fan motor connector (CN72)?	<ul style="list-style-type: none"> • Fan motor of the indoor is faulty
		2) The fan motor of the indoor unit doesn't run	<ul style="list-style-type: none"> • Fan motor connector(CN72) is faulty
		3) The power voltage between terminal #3-#5 of the connector(CN72) is 0V	<ul style="list-style-type: none"> • PBA is faulty

10-2-4 Outdoor detailed inspection procedure

No.	Procedure	Inspection Method	Cause
1	Plug out and pull the PCB out of the control box. Check the PCB fuse (Wait 3 minutes after power off)	1) Is 1st fuse disconnected?	<ul style="list-style-type: none"> Over current AC part and pattern short of Outdoor PBA
2	Check the Wiring	1) Is the Compressor wire connected clockwise? 2) Is the Reactor wire connected normal? 3) Is the Fan wire connected normal? 4) Is the 4way wire connected normal? 5) Is the sensor wire connected normal? 6) Is the EEV wire connected normal?	<ul style="list-style-type: none"> Wrong assembly Installation(service) condition is bad
3	"Supply power and operate the set (Use Remote-control, button in indoor set)"	Check the power voltage	
		1) Is the voltage between Terminal block L-N 200Vac~240Vac?	<ul style="list-style-type: none"> Power cord is faulty, Wrong Power cable Wiring
		2) Is the C006 voltage 200Vac~240Vac?	<ul style="list-style-type: none"> Fuse open .L,N,F1,F2 wire wrong wiring (Terminal Block-PBA)
		3) Is the CN150 voltage 200Vac~240Vac?	<ul style="list-style-type: none"> Power circuit is faulty Load short
		4) Is the PFC050(#26-#27) voltage 200Vac~240Vac after 3 minutes later?	<ul style="list-style-type: none"> Fuse open L,N,F1,F2 wire wrong wiring (Terminal Block-PBA) .PTC020 open .RY021, RY022 is faulty Outdoor Micom(IC201) error
		5) Is the CE101 voltage 280Vdc~320dc after 3 minutes later?	<ul style="list-style-type: none"> PFC050 is faulty Reactor wire is wrong connection Power circuit is faulty, Load short BLDC Fan motor error
		6) Is the voltage CN151 #1-#2 voltage 15Vdc?	<ul style="list-style-type: none"> Switching Trans of Power circuit is faulty Load short
		7) Is the voltage CN152 #1-#2 voltage 12Vdc?	<ul style="list-style-type: none"> Switching Trans of Power circuit is faulty Load short
		8) Is the voltage CN151 #3-#2 voltage 5Vdc?	<ul style="list-style-type: none"> Switching Trans of Power circuit is faulty Load short
4	Check the LED lamp display	1) Normal : RED on, GRN blink, YEL off 2) Abnormal - All o check no power - abnormal display : check error mode	<ul style="list-style-type: none"> F1,F2 wire wrong wiring Outdoor PBA is faulty

11. Reference Sheet

11-1 Low Refrigerant Pressure Distribution

Note : Please measure the refrigerant pressure after the air conditioner operates on testing cooling mode during more than 10 minutes.

- Indoor Temp. Variation : 20°C ~ 32°C
- Outdoor Temp. Variation : -5°C ~ 45°C

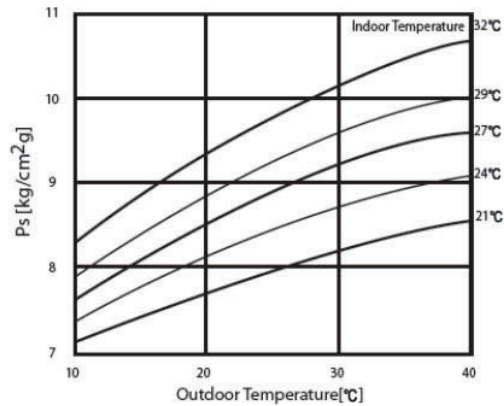

11-2 Pressure & Capacity mark

■ Power/Heat

W	cal/s	kcal/h	Btu/h	HP	kg.m/s	lb.m/s
1	0.23885	0.85985	3.4121	0.001341	0.10197	0.73756
4.1868	1	3.6	14.286	0.0056146	0.42693	3.088
1.163	0.27778	1	3.9683	0.0015596	0.11859	0.85778
0.29307	0.06999	0.252	1	3.9302x10 ⁻⁴	0.029885	0.21616
745.7	178.11	641.19	2,544.4	1	76.04	550
9.8067	2.3423	8.4322	33.462	0.013151	1	7.233
1.3558	0.32383	1.0658	4.6262	0.0018182	0.13826	1

11-3 Q & A for Non-trouble

Classification	Class	Description
Cooling	Q	The cooling is weak.
	A	When it is hot outside, its cooling capacity decreases due to the increase of the ambient temperature. When the dust filter gets blocked or warm outside air gets in, the cooling capacity will decrease. So, make sure to clean the dust filter frequently, prevent heat loss by closing the doors and insulate the cooling area by using curtains, blinds, shades or window tinting.
	Q	The cooling is good generally. But, it gets weak when it is considerably hot.
	A	It occurs when the outdoor unit is exposed to direct sun light and heat-up air is not ventilated well. So, set up a sunblind over the outdoor unit and keep it away from the unit to increase the ventilation. When the cooling capacity decreases during a heat wave, clean the heat exchanger of the outdoor unit or spray some cold water to the heat exchanger to increase the cooling capability.
	Q	The cooling is weak. Does it need refrigerant charging?
	A	It is not correct charging refrigerant regularly. Except that you have moved in several times or the connection pipes are broken, the refrigerant does not run low. So, when refrigerant is additionally charged, it could be costly and cause a product's failure. When the refrigerant leaks, all of it will escape in a short time resulting in cooling failure and no water coming out of the drain hose. So, if water comes out from the drain hose, it indicates the normal operation of the product and it does not need refrigerant charging.
	Q	It fails to do cooling.
A	When the air conditioner is set to ventilation or the desired temperature is set higher than the current temperature, it fails to do cooling. In this case, select cooling or set the desired temperature lower.	
Leakage	Q	It floods the floor.
	A	Place the drain hose properly. When it is not placed properly, the drain water would flow back flooding the floor. So, straighten out the drain hose for the water to be drained well.
	Q	Water drips at the drain connection (service valve) of the outdoor unit.
	A	When a glass bottle is taken out of the refrigerator, moisture gets condensed on its surface due to the temperature differences. The same principle applies to the air conditioner. When cold refrigerant goes through the copper tube, moisture gets condensed on the surface of the tube and the connection areas. To prevent the water condensation, the pipes are insulated. But, the connection areas of the outdoor unit are not insulated for the purpose of maintenance or repair, and water gets condensed due to the temperature differences and drips down. Generally, it evaporates right away. But, when it drips much during muggy days, put a water pan on the floor.
	Q	It leaks even though a drain pump is used.
A	It occurs when the drain pump is plugged out or it is out of order. Check the power of the drain pump and the position of the drain hose, and when the pump is faulty, contact the drain pump manufacturer. Samsung Electronics do not manufacture drain pumps. So, we are not able to correct the drain pump problems.	
Smells	Q	Whenever the air conditioner is turned on, it irritates my eyes and gives me a headache.
	A	There are no components in the air conditioner irritating the eyes and sending out chemical smells. But, when the air conditioner is turned on, other smell sources are sucked into the air conditioner and get out of it. So find and root out the smell sources. Generally, it occurs at a interior renovated place, a pharmacy, a gasoline handling place, a tire shop, a second-hand book shop or an electronic component handling place, when its chemical or musty smells are sucked in and sent out, it can be misled that the air conditioner generates them.

Classification	Class	Description
Smells	Q	Whenever the air conditioner is turned on, it stinks.
	A	When are no components in the air conditioner sending out chemical smells. But, when the air conditioner is turned on, other smell sources are sucked into the air conditioner and get out of it. So, find and root out the smell sources. Generally, when the drain hose is taken out to the washing room or there are sources of smells such as a diaper bin, a shoe shelf or a socks bin, bad smells generate. Also, it occurs where glass cleaners or air fresheners are used; when they are sucked in interacting with dusts and moistures inside, bad smells generate. these kinds of organic materials noxious to human bodies. So, we recommend against the use of them.
	Q	Whenever the air conditioner is turned on, it smells sour.
	A	When the room is papered recently, its paste smells would be sucked inside. Also, when the air conditioner is installed in the study room of young boys loving sweat-generating activities such as the basketball, excessive sweats evaporate and get sucked into the air conditioner resulting in bad smells. So, find and root out problem or refresh the room frequently.
	Q	Whenever the air conditioner is turned on, it smells musty.
	A	It is due to the improper keeping of the product after its use. When keeping the product, dry up the inside with the operation of ventilation to prevent must. When the product is kept without drying up the inside with ventilation, mold would grow inside resulting in must. So, open the windows and switch on the ventilation function to get rid of the saturated smell inside.
	Q	Whenever the air conditioner is turned on, it sends out bad smells such as stale smells.
	A	It occurs generally when there are pet animals in the house. Their smells stay at the same place. But, when the air conditioner is turned on, the air gets circulated resulting in the circulation of the smells. So, find and root out the problem or refresh the room frequently.
	Q	It sends out bad smells.
A	When the air filter is filthy, it could send out bad smells. So, clean the filter and ventilate the room with the windows open while operating the ventilation function.	
Operation	Q	It won't start.
	A	There is a power failure or it is plugged out. Also, check if the power distribution panel is switched o.
	Q	It goes off during operation.
	A	When the hot air does not escape properly, it goes o during operation. it occurs when it does not ventilate properly because the outdoor unit is covered, the back of the outdoor unit is blocked by a cardboard or a plywood panel, and the front of the outdoor unit is blocked by the closed window or other obstacles. Clear the above obstacles from the outdoor unit.
	Q	It generally works properly. But, when it's considerably hot, it goes off during operation.
	A	It occurs when the outdoor unit is exposed to direct sunlight and the hot air does not escape properly. Set up a sun blind over the outdoor unit and clear the neighboring obstacles from the outdoor unit to provide good ventilation. When it goes o frequently during a heat wave, it would prevent the turno and increase the cooling capacity cleaning the outdoor unit or spraying some water to the heat exchanger.
	Q	The remote controller won't operate.
	A	When the batteries run out or the transmitter or receiver of the remote controller is blocked by obstacles, change the batteries or keep the obstacles away from the controlling area. Also, the remote controller may mot work under intensive light from a 3-wave length lamp or a neon sign due to the EMI. In this case, take the remote controller closer to the receiver.

Classification	Class	Description
	Q	Who installs the air conditioner? (Relocation/Re-installation)
	A	When relocating or re-installing the air conditioner, make sure to contact Samsung Electronics Service Center or Authorized Service Agent and have them to do the job. (If not, it could cause personal injury or product damage.) The cost for the relocation/re-installation of the air conditioner is subject to the customer's expense. There is a cost table. But, our service engineer needs to visit to total up the cost correctly. When you move in, make sure to contact Samsung Electronics Service Center or Authorized Service Agent in advance to streamline the process.
	Q	Is it possible to install the outdoor unit outside?
	A	It is possible to install it at a designated place in the apartment or on the rooftop nearby. But, it's illegal hanging an angle iron case with the outdoor unit in it outside the apartment. Also, it is illegal obstructing passers-by with the outdoor unit installed outside.
	Q	What can be done to install the outdoor unit facing the road because it is a commercial building?
	A	The following is an excerpt from building code going into effect from JUNE 1 st 2005. "The exhaust pipe of a cooling or ventilation facility installed in a building adjacent to the streets of commercial or residential areas shall be installed higher than 2 m to prevent the exhaust air from blowing directly to passersby and the current facilities shall be corrected by MAY 31 st 2005." So, please install it higher than 2 m or not to blow the hot exhausting air directly to passers-by.
	Q	What about installing a windscreen during installation not to blow hot air directly to passers-by?
	A	When the hot air from the front of the outdoor unit is blocked, the product's performance will be affected and it will fail to operate properly. So, keep it at least 300mm away from its surrounding walls and give it good ventilation.

11-4 Cleaning /Filter Change

Auto clean function

Use the Auto clean function if the indoor unit produces odors.

Activating Auto clean

To activate Auto clean, press the  (Options) button for at least 3 seconds.

The indoor unit display shows:



If the air conditioner is off, Auto clean starts immediately. If the air conditioner is running, Auto clean starts as soon as the air conditioner turns off.

NOTE

- You can also activate Auto clean from the Options menu:

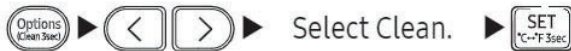

- Once Auto clean is selected, it is always activated whenever the air conditioner turns off.
- Auto clean runs for 10 to up to 30 minutes depending on internal dry conditions. The indoor unit display shows the cleaning progress from 1% to 99%.
- If you start another function while Auto clean is progressing, Auto clean pauses and will resume when the other function stops.
- When Auto clean completes, the air conditioner turns off.

Canceling Auto clean

To cancel Auto clean while it is running, follow the procedure below:



or



NOTE

- Canceling Auto clean does not deactivate it.

Deactivating Auto clean

To deactivate Auto clean, follow the procedure below while the air conditioner is in operation or turned off:



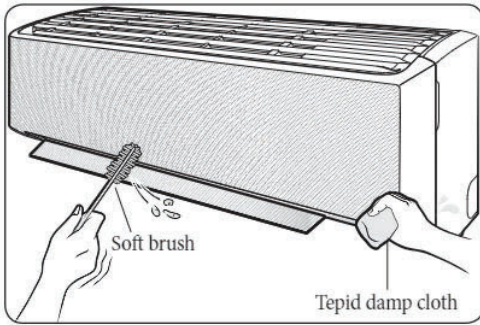

Cleaning the outside of the indoor unit

- 1 Turn off the air conditioner and wait until the fan stops.
- 2 Disconnect the power supply.
- 3 Use a soft brush or tepid damp cloth to clean the exterior.

⚠ WARNING

- Do not clean the appliance by spraying water directly onto it. Water entering the unit may result in electric shock or fire that could cause death, serious injury, or property damage:

⚠ CAUTION

- Do not use an alkaline detergent to clean the indoor unit display.
- Do not use sulphuric acid, hydrochloric acid, or organic solvents such as paint thinner, kerosene, acetone, benzene, or alcohol to clean the unit surfaces.

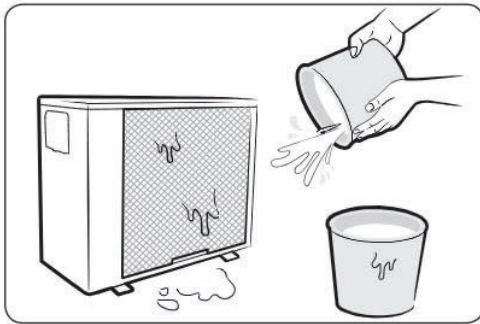

Cleaning the heat exchanger on the outdoor unit

- 1 Turn off the air conditioner and wait until the fan stops.
- 2 Disconnect the power supply.
- 3 Spray water on the heat exchanger to remove dust and other debris.

⚠ CAUTION

- Do not use sulphuric acid, hydrochloric acid, or organic solvents such as paint thinner, kerosene, acetone, benzene, or alcohol to clean the unit surfaces.
- If you need to inspect or clean the inside of the heat exchanger on the outdoor unit, contact a local service centre for help.

Cleaning the filter

Clean the air filter every two weeks or when the **CF** (filter-cleaning reminder) appears on the indoor unit display. The time between cleanings may vary, depending on the usage and environmental conditions.

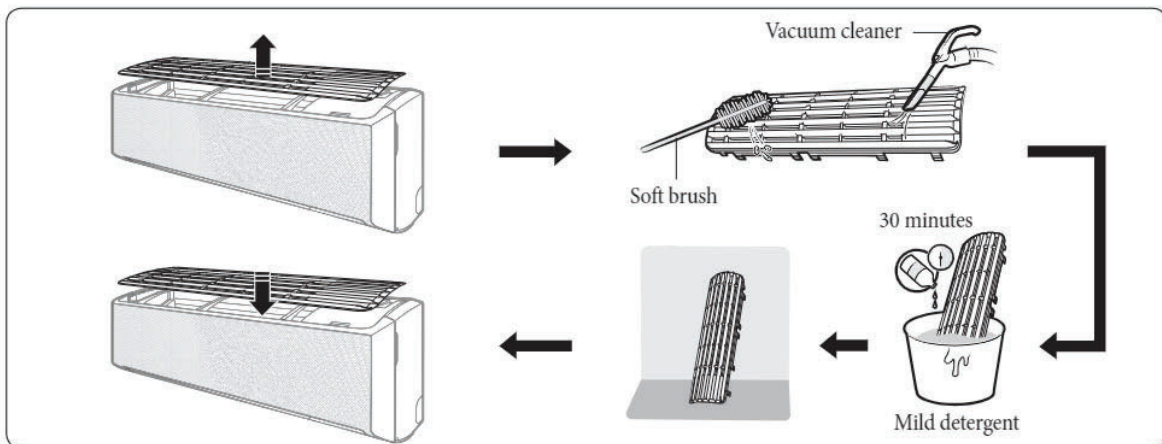

-
- 1 Slide the filter off of the unit.
 - 2 Use a soft brush or vacuum cleaner to remove any dust or debris on the filter.
 - 3 Soak the filter in a solution of water and mild detergent for 30 minutes.
 - 4 Rinse the filter and let it air dry in a well-ventilated area that is out of direct sunlight.
 - 5 Reinstall the filter.
 - 6 Reset the filter-cleaning reminder:

In operation ►  ►   ► Select Filter Reset. ► 

 **CAUTION**

- Take care not to damage the filter during cleaning.
- Do not scrub the air filter with a hard-bristle brush or another cleaning utensil.
- Do not expose the air filter to direct sunlight when drying it.

11-5 Installation

11-5-1 Before Installation

Keep the air conditioner outlet and inlet free from its surroundings. In case of installation, keep the symmetry and fix it to prevent vibration. The pipe length shall meet the standard as far as possible.

11-5-2 Installation Procedure

■ Location

Install the product in an area to guarantee the best cooling effect, convenience of piping and electric work, and inexistence of vibration or wind.

■ Wall Drilling

Drill the wall downward in a diameter of 60 to 65mm.

■ Fixing Indoor Unit & Outdoor Unit

Fix the air conditioner indoor unit securely to the wall. Secure the outdoor unit in a suitable position.

■ Pipe Spooling & Connecting

You shall cut the pipe with a pipe cutter and grind all the burrs of the cut surface. pipe expansion may continue until the pipe surface becomes uneven or torn apart. Be sure to use a torque wrench to tighten pipes or are nuts.

<Torque & Depth>

Outer Diameter (D)	Torque(kgf-cm)	Depth(A)
ø6.35 mm(1/4")	140~170	1.3 mm
ø9.52 mm(3/8")	250~280	1.8 mm
ø12.70 mm(1/2")	380~420	2.0 mm
ø15.88 mm(5/8")	440~480	2.2 mm
ø19.05 mm(4/4")	9900~1,210	2.2 mm

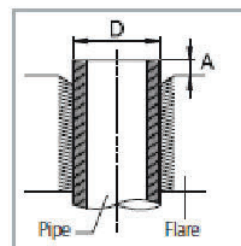

■ Leak Test

Put an inset gas like nitrogen in the outdoor unit pipe and put soap bubbles or other test liquids on the pipe surface for the leak test.

■ Drain Hose Connecting

Install the drain hose downward to drain water naturally. Be sure to pour water into the hose to check if it drains well.

■ Electric & Earth Work

Electric and earth work shall meet the "Electric Facility Technology Standard" and the "Internal Wire Regulation" of the Electric Business Laws.

■ Inspection & Trial Run

Upon completion of the tests, you shall make a trial run while you explain the main functions of the air conditioner to finish the installation.

11-6 Installation Diagram of Indoor Unit and Outdoor Unit

11-6-1 Air-Purge Procedure

1) Connect each assembly pipe to the appropriate valve on the outdoor unit and tighten the flare nut.



2) Connect the charging hose of low pressure side of manifold gauge to the packed valve having a service port (3/8" Packed valve) as shown at the figure.



3) Open the valve of the low pressure side of manifold gauge counter-clockwise.



4) Purge the air from the system using vacuum pump for about 30 minutes.
- After that, please recheck that pressure is stabilized.
- Close the valve of the low pressure side of manifold gauge clockwise.
- Remove the hose of the low pressure side of manifold gauge.



5) Set valve cork of both liquid side and gas side of packed valve to the open position.



6) Mount the valve stem nuts to the 2 way and 3 way valve. And mount the service port cap to 3 way valve.



7) Check for gas leakage.
- At this time, especially check for gas leakage from the 3 way valve's stem nuts, and from the service port cap.

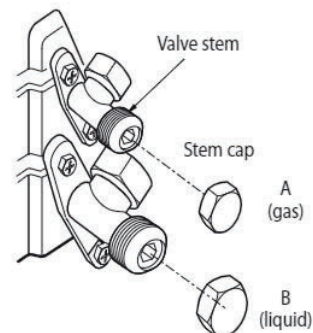
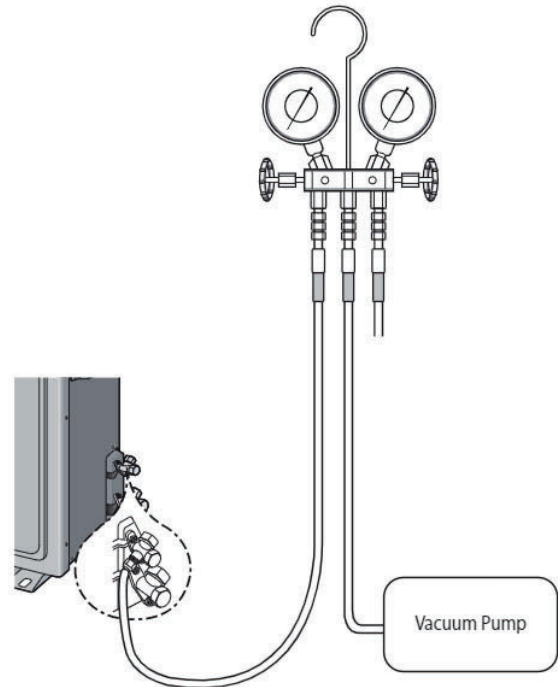
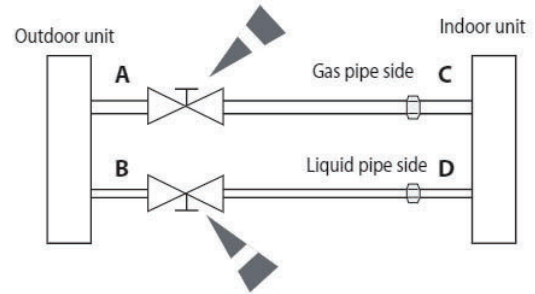

11-6-2 "Pump down" Procedure

Pump down will be carried out when an evaporator is replaced or when the unit is relocated in another area.

1) Remove the caps from the 3 way valve and the 3 way valve.



2) Turn the 3 way valve clockwise to close and connect a pressure gauge (low pressure side) to the service valve, and open the 3 way valve again.



3) Set the unit to cool operation mode.
(Check if the compressor is operating)



4) Turn the 3 way valve clockwise to close.



5) When the pressure gauge indicates "0" turn the 3 way valve clockwise to close.



6) Stop operation of the air conditioner.



7) Close the cap of each valve.

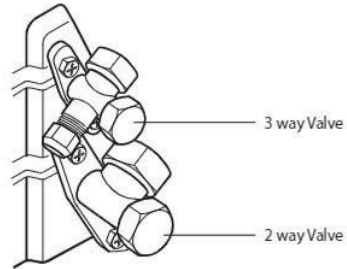

Remarks

Relocation of the air conditioner

- Refer to this procedure when the unit is relocated.
- Carry out the pump down procedure (refer to the details of 'pump down').
- Remove the power cord.
- Disconnect the assembly cable from the indoor and outdoor units.
- Remove the flare nut connecting the indoor unit and the pipe.
- At this time, cover the pipe of the indoor unit and the other pipe using a cap or vinyl plug to avoid foreign material entering.
- Disconnect the pipe connected to the outdoor unit.
At this time, cover the valve of the outdoor unit and the other pipe using a cap or vinyl plug to avoid foreign material entering.
- Make sure you do not bend the connection pipes in the middle and store together with the cables.
- Move the indoor and outdoor units to a new location.
- Remove the mounting plate for the indoor unit and move it to a new location.

11-7. Reference Sheet

Index for Model Name

1st	2nd	3rd	4th	5th	6th	7th	8th	9th	10th	11th	12th	13th	14th
Project		Capacity		Sell	Feature		Series		Color		Unit	Export	
A	R	1	2	B	S	F	C	M	W	K	N/X	C	V

Item	1st	2nd
RAC	A	R

Item	Reference	3rd	4th
1	Export	1	0
2	Export	1	3
3	Export	1	8
4	Export	2	4

Item	5th	Item	6th
19 Year	R	INVERTER HPR32	X
20 Year	T	INVERTER CO R32	Y
21 Year	A	INVERTER HPR-410A	S
22 Year	B	INVERTER CO R-410A	V

Item	7th
Motion detect + PM1.0 Filter + PM1.0 Sensor + Wifi	A
Motion detect + PM1.0 Filter + Wifi	B
Motion detect + Wifi + Tri-care filter	C
Motion detect + Wifi	D
Wifi + Tri-care filter	E
Wifi	F
Tri-care filter	G
none	H
Good1 ,swing	J

Item	8th
WindFree GEO	A
WindFree AIRISE	C
Wind GEO	Y
Wind AIRISE	Z

Item	9th
1ST MODEL	A
2nd MODEL	B
...	
18 th Model	R

Division	Series	Project	Color Name	Division component	Sinkeolreo code (10th,11th)	Remark
QMD	A	GEO (WindFree)	DA White	Grille	WK	
	C	AIRISE (WindFree)	DA White	Grille	WK	
	Y	GEO (Wind)	DA White	Grille	WK	
	Z	AIRISE (Wind)	DA White	Grille	WK	

Item	12th
SET	/
IN	N
OUT	X

The existing code	The sales area	CIS Description	The integrated code (13th,14th)
CV	AMERICA	KCV	CV

SAMSUNG

ELECTRONICS

GSPN (GLOBAL SERVICE PARTNER NETWORK)

Area	Web Site
North America	http://gspn3.samsungcsportal.com
Latin America	http://gspn3.samsungcsportal.com
CIS	http://gspn1.samsungcsportal.com
Europe	http://gspn1.samsungcsportal.com
China	http://china.samsungportal.com
Asia	http://gspn2.samsungcsportal.com
Middleeast & Africa	http://gspn1.samsungcsportal.com

This Service Manual is a property of Samsung Electronics Co., Ltd.
Any unauthorized use of Manual can be punished under
applicable International and/or domestic law.

© Samsung Electronics Co., Ltd.
September 2021

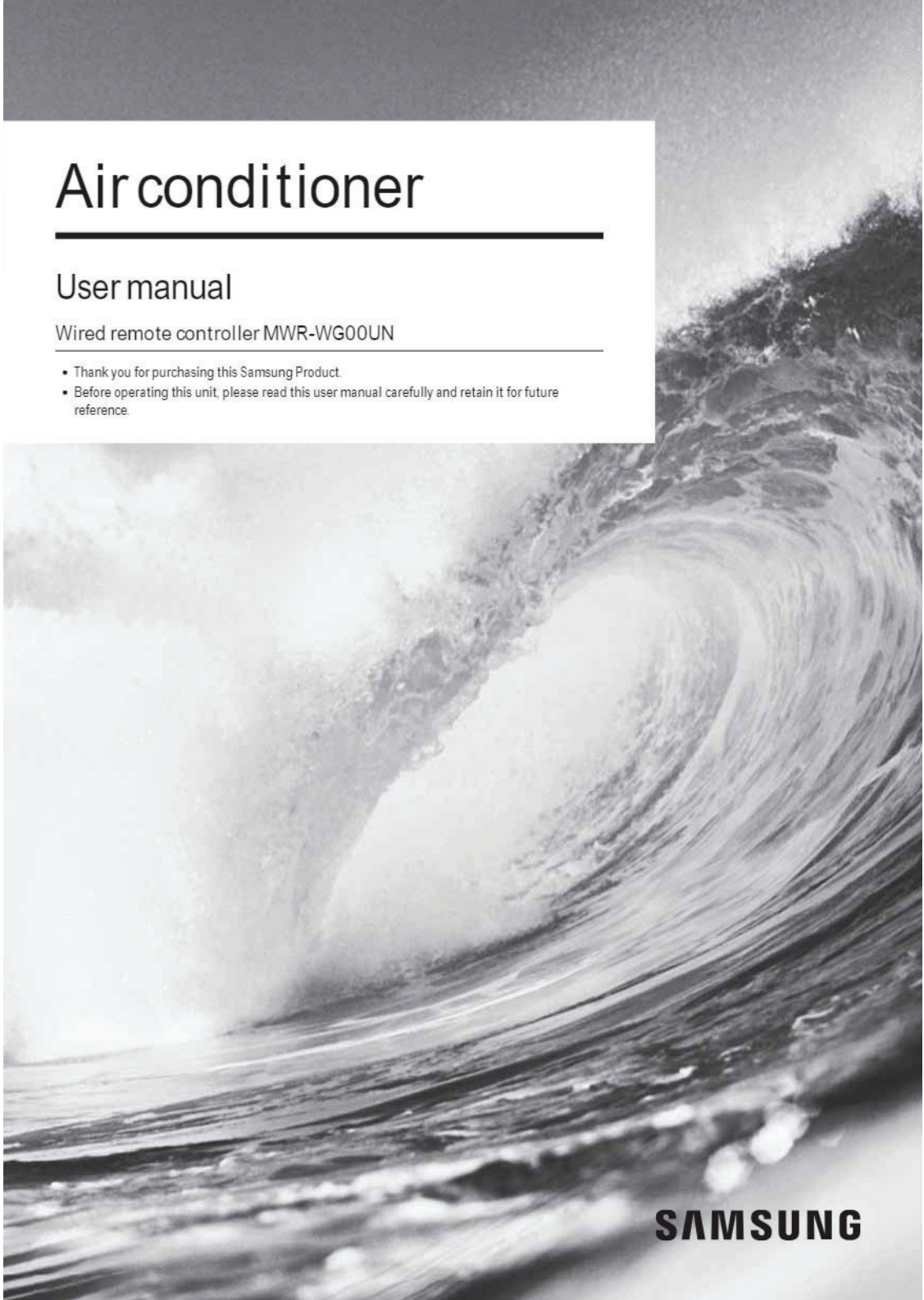

Air conditioner

User manual

Wired remote controller MWR-WG00UN

- Thank you for purchasing this Samsung Product.
- Before operating this unit, please read this user manual carefully and retain it for future reference.

SAMSUNG

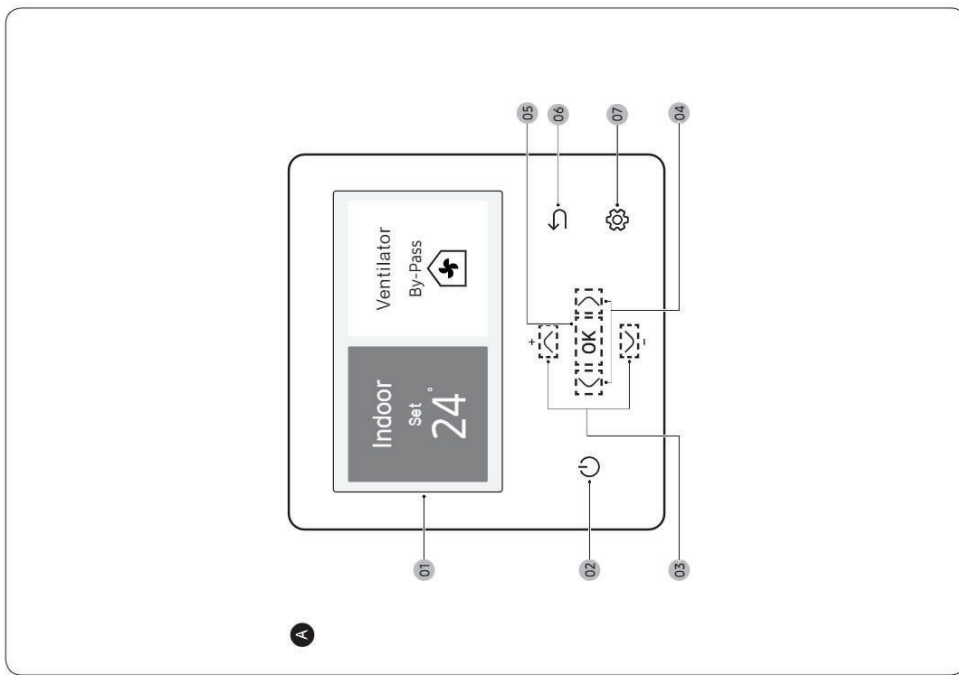

EN

A Remote Controller Overview

- 01 Operation status display
 - Displays the operation/function settings and statuses.
- 02 Operation On/Off button (LED display)
 - Turns the air conditioner/ventilator power On/Off
- 03 Up/Down button
 - Moves between items vertically or changes the set temperature.
- 04 Left/Right button
 - Moves between items horizontally or changes the item value.
- 05 OK button
 - Saves your new settings.
- 06 Save & Return button
 - Saves your new settings and returns to the previous step.

07 Option button

- Selects the detailed setting function.
- NOTE**
- The operation mode display on the remote controller changes depending on the selected language.
 - Some functions may not be available, depending on the indoor unit specifications.
 - You can see the operation status on the LED display.
 - ON: Operating.
 - Blinking: An error occurred.
 - OFF: Turns off.

ES

A Descripción general del control remoto

- 01 Pantalla de estado de funcionamiento
 - Muestra los ajustes y estados de funcionamiento o función.
- 02 Botón de funcionamiento On/Off (pantalla LED)
 - Apaga o enciende la alimentación del aire acondicionado/ventilador
- 03 Botón Arriba/Abajo
 - Se mueve verticalmente entre los elementos o cambia la temperatura.
- 04 Botón Izquierda/Derecha
 - Se mueve horizontalmente entre los elementos o cambia el valor del elemento.
- 05 Botón OK
 - Guarda sus ajustes nuevos.
- 06 Botón Guardar y Volver
 - Guarda sus nuevos ajustes y vuelve al paso anterior.

07 Botón Opción

- Selecciona la función de ajuste detallado.
- NOTA**
- La pantalla de modo de funcionamiento de control remoto cambia según el idioma seleccionado.
 - Es posible que algunas funciones no estén disponibles, según las especificaciones de la unidad interna.
 - Puede ver el estado de funcionamiento en la pantalla LED.
 - ENCENDIDO: Funcionando.
 - Parpadeo: Se ha producido un error.
 - OFF: Apaga.

FR

A Aperçu de la télécommande

- 01 Affichage de l'état de fonctionnement
 - Affiche les réglages et les états du fonctionnement de la fonction.
- 02 Bouton de mise en marche/arrêt (affichage LED)
 - Met le climatiseur/ventilateur en marche/arrêt.
- 03 Bouton haut/bas
 - Parcourt les éléments verticalement ou modifie la température configurée.
- 04 Bouton gauche/droite
 - Parcourt les éléments horizontalement ou modifie la valeur de l'élément.
- 05 Bouton OK
 - Enregistre vos nouveaux réglages.
- 06 Bouton d'enregistrement de votre
 - Enregistre vos nouveaux réglages et retourne à l'étape précédente.

07 Bouton Option

- Sélectionne la fonction de réglage avancé.
- REMARQUE**
- L'affichage du mode de fonctionnement sur le télécommande change en fonction de la langue sélectionnée.
 - La disponibilité de certaines fonctions dépend des spécifications de l'unité interne.
 - Vous pouvez voir l'état de fonctionnement sur l'affichage LED.
 - ON: En fonctionnement.
 - Clignotant: Une erreur s'est produite.
 - OFF: S'éteint.

PT

A Descrição geral do controlo remoto

- 01 Ver o estado de funcionamento
 - Exibe as definições e os estados de funcionamento/função.
- 02 Botão Ligar/Desligar (funcionamento/visão LED)
 - Liga/Desliga o aparelho de ar condicionado/ventilador
- 03 Botão Para cima/Para baixo
 - Navega verticalmente entre itens ou altera a temperatura definida.
- 04 Botão Esquerda/Direita
 - Navega horizontalmente entre itens ou altera o valor de um item.
- 05 Botão OK
 - Guarda as suas novas definições.
- 06 Botão Guardar & Voltar
 - Guarda as suas novas definições e volta ao passo anterior.

07 Botão Opção

- Selecciona a função de definições detalhadas.
- NOTA**
- O ecrã do modo de funcionamento/controlo remoto altera de acordo com o idioma selecionado.
 - Algumas funções podem não estar disponíveis, dependendo das especificações da unidade interior.
 - Pode ver o estado de funcionamento no visor LED.
 - LIGADO: em funcionamento.
 - Intermitente: ocorreu um erro.
 - OFF: desliga-se.

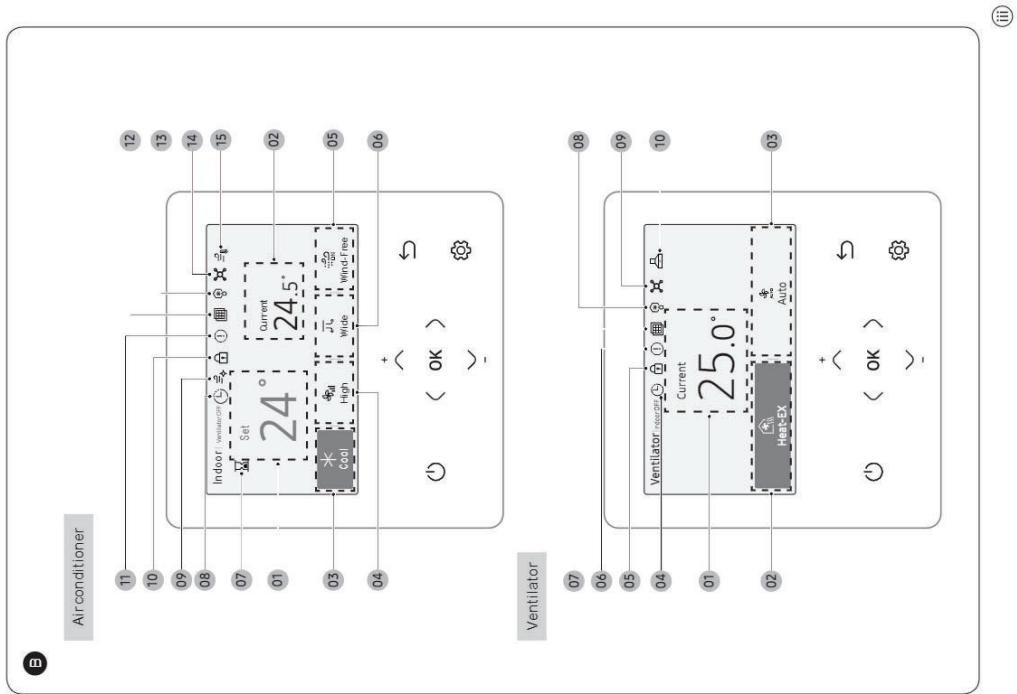
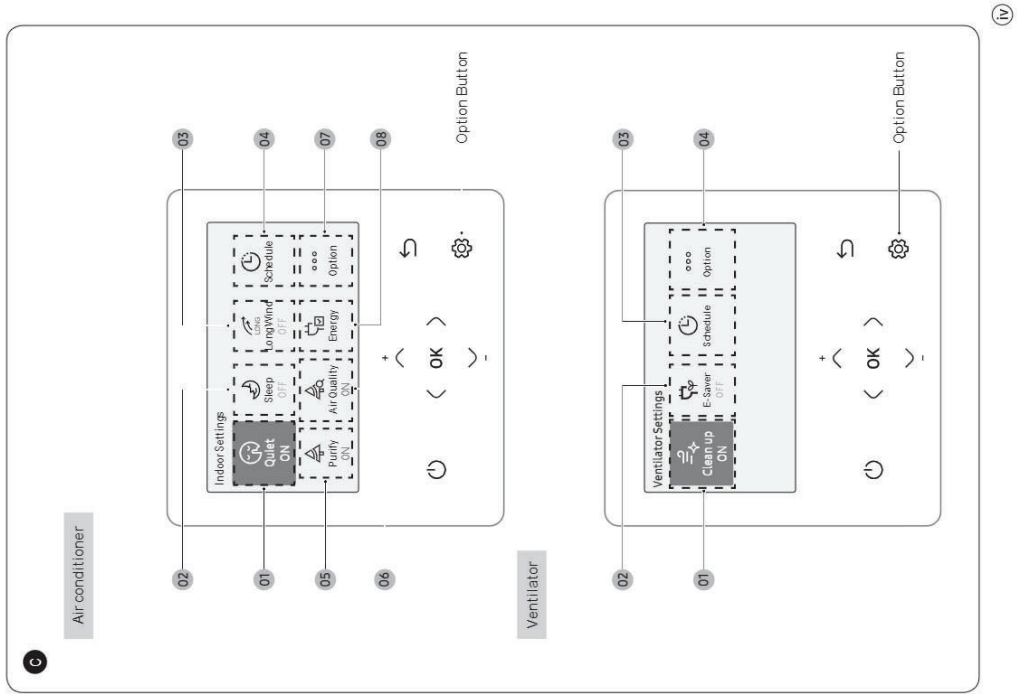

B Home Screen Overview

EN

Air conditioner

- | | |
|--|---|
| <ul style="list-style-type: none"> 01 Set temperature display 02 Current temperature display 03 Operation mode display <ul style="list-style-type: none"> - Displays any of Auto, Cool, Dry, Fan, and Heat. 04 Fan speed display <ul style="list-style-type: none"> - Displays any of Auto, Turbo, High, Medium, and Low. 05 Wind-Free display 06 Air flow direction display <ul style="list-style-type: none"> - Displays any of Fix, Spot, Mid, Wide, Swing, and Individual. 07 Activation Time Setting display <ul style="list-style-type: none"> - When Energy Saving Timer is activated. - When Override time is activated. | <ul style="list-style-type: none"> 08 Schedule indicator <ul style="list-style-type: none"> - When a General Schedule is set. - When a Setback Schedule is set. 09 Clean indicator 10 Lock indicator 11 Check indicator 12 Filter reset indicator 13 Defrost indicator 14 Central Control indicator 15 Discharge temperature indicator |
|--|---|

Ventilator

- | | |
|--|---|
| <ul style="list-style-type: none"> 01 Current temperature display 02 Operation mode display <ul style="list-style-type: none"> - Displays any of Heat-EX, Auto, By-Pass, Quiet, and Away. 03 Fan speed display <ul style="list-style-type: none"> - Displays any of Auto, Turbo, High, and Low. 04 Schedule indicator <ul style="list-style-type: none"> - When a General Schedule is set. - When a Setback Schedule is set. 05 Lock indicator 06 Check indicator | <ul style="list-style-type: none"> 07 Filter reset indicator 08 Defrost indicator 09 Central Control indicator 10 Range hood (Exhaust hood) indicator <p>NOTE</p> <ul style="list-style-type: none"> • Unavailable functions are marked inactive and they cannot be set. • The locations of icons may differ depending on the function. • When you do not press any button for 7 seconds, the function of the position is automatically selected. |
|--|---|

C Settings Screen Overview

Press the  button to enter the Settings screen and then select the desired function or option.

Air conditioner

- | | |
|--|--|
| <ul style="list-style-type: none"> 01 Quiet display <ul style="list-style-type: none"> - Displays the Quiet function. 02 Sleep display <ul style="list-style-type: none"> - Displays the Sleep function. 03 Long Wind display <ul style="list-style-type: none"> - Displays the Long Wind function. 04 Schedule display <ul style="list-style-type: none"> - Displays any of Timer, Weekly schedule, Yearly schedule, and Holiday. | <ul style="list-style-type: none"> 05 Purify display <ul style="list-style-type: none"> - Displays the Purify function. 06 Air Quality display <ul style="list-style-type: none"> - Displays the Air Quality. 07 Option display <ul style="list-style-type: none"> - Displays the Option. 08 Energy display <ul style="list-style-type: none"> - Displays any of Energy Usage, Energy Saving, and Energy Settings. |
|--|--|

Ventilator

- | | |
|--|---|
| <ul style="list-style-type: none"> 01 Clean up display <ul style="list-style-type: none"> - Displays the Clean up function. 02 E-Saver display <ul style="list-style-type: none"> - Displays the E-Saver function. 03 Schedule display <ul style="list-style-type: none"> - Displays any of Timer, Weekly schedule, Yearly schedule, and Holiday. | <ul style="list-style-type: none"> 04 Option display <ul style="list-style-type: none"> - Displays the Option. <p>NOTE</p> <ul style="list-style-type: none"> • Unavailable functions are marked inactive and they cannot be set. • In the menu with the > in the Option menu, you can select a menu with the > button. • When you do not press any button for 180 seconds with the option active, the settings are not saved and the Home screen appears. |
|--|---|

V

B Descripción general de la pantalla de inicio

ES

Aire acondicionado

- | | |
|--|---|
| 01 Pantalla temperatura establecida | 08 Indicador de Programa |
| 02 Pantalla temperatura actual | - Cuando se establece una Horario. |
| 03 Pantalla modo de funcionamiento | - Cuando se establece una Retrasar Horario. |
| - Muestra cualquiera de los valores Auto, Frío, Seco, Vent o Calor. | 09 Indicador de Limpiar |
| 04 Pantalla de velocidad del ventilador | 10 Indicador de Bloqu. |
| - Muestra cualquiera de los valores Auto, Turbo, Alto, Medio o Bajo. | 11 Indicador de comprobación |
| 05 Pantalla de Wind-Free | 12 Indicador de Reinicio de filtro |
| 06 Pantalla de dirección del flujo de aire | 13 Indicador de Desescarche |
| - Muestra cualquiera de los valore Fijo, Concentrado, Medio, Amplio, Swing o Individual. | 14 Indicador de Control central |
| 07 Visualización de Ajustes de Activación | 15 Indicador de Tª de descarga |
| - Cuando se activa Temporizador de Ahorro Energético. | |
| - Cuando se activa el tiempo de Anular. | |

Ventilación

- | | |
|--|--|
| 01 Pantalla temperatura actual | 07 Indicador de Reinicio de filtro |
| 02 Pantalla modo de funcionamiento | 08 Indicador de Desescarche |
| - Muestra cualquiera de los valores Recup., Auto, By-Pass, Silencioso o Ausente. | 09 Indicador de Control central |
| 03 Pantalla de velocidad del ventilador | 10 Indicador de Extractor (Campana extractora) |
| - Muestra cualquiera de los valores Auto, Turbo, Alto o Bajo. | |
| 04 Indicador de Programa | |
| - Cuando se establece una Horario. | |
| - Cuando se establece una Retrasar Horario. | |
| 05 Indicador de Bloqu. | |
| 06 Indicador de comprobación | |

NOTA

- Las funciones no disponibles se marcan como inactivas y no se pueden establecer.
- La ubicación de los iconos puede diferir según cada función.
- Si no presiona ningún botón durante siete segundos, la función de la posición se selecciona automáticamente.

C Descripción general de la pantalla de ajustes

Pulse el botón  para entrar en la pantalla de ajustes y, a continuación, seleccione la función u opción deseada.

Aire acondicionado

- | | |
|--|---|
| 01 Pantalla Silen. | 05 Pantalla Lmp. |
| - Muestra la función Silen. | - Muestra la función Lmp. |
| 02 Pantalla Sleep | 06 Pantalla Calidad Aire |
| - Muestra la función Sleep. | - Muestra la Calidad Aire. |
| 03 Pantalla Long Wind | 07 Pantalla Opción |
| - Muestra la función Long Wind. | - Muestra la Opción. |
| 04 Pantalla Programa | 08 Pantalla Energía |
| - Muestra cualquiera de los siguientes valores: Temporizador, Programa semanal, Programa anual o Vacaciones. | - Muestra cualquiera de los siguientes valores: Consumo de energía, Eco o Ajustes de energía. |

Ventilación

- | | |
|--|--|
| 01 Pantalla Lmp. | |
| - Muestra la función Lmp. | |
| 02 Pantalla Eco | |
| - Muestra la función Eco. | |
| 03 Pantalla Programa | |
| - Muestra cualquiera de los siguientes valores: Temporizador, Programa semanal, Programa anual o Vacaciones. | |
| 04 Pantalla Opción | |
| - Muestra la Opción. | |

NOTA

- Las funciones no disponibles se marcan como inactivas y no se pueden establecer.
- En el menú con el signo > dentro del menú Opción, podrá seleccionar un menú con el botón >.
- Si no pulsa ningún botón durante 180 segundos con la opción activa, los ajustes no se guardan y aparece la pantalla de inicio.

vi

B Aperçu de l'écran d'accueil

FR

Climatiseur

- | | |
|---|--|
| <ul style="list-style-type: none"> 01 Affichage de la température configurée 02 Affichage de la température actuelle 03 Affichage du mode de fonctionnement <ul style="list-style-type: none"> - Affiche n'importe laquelle de ces options : Auto, Froid, Sec, Ventil, et chaud. 04 Affichage de la vitesse du ventilateur <ul style="list-style-type: none"> - Affiche n'importe laquelle de ces options : Auto, Turbo, Grande, Moyenne, et Petite. 05 Affichage Wind-Free™ 06 Affichage de la direction du flux d'air <ul style="list-style-type: none"> - Affiche n'importe laquelle de ces options : Fixe, Fixe, Moyen, Large, Balayage, et Individuelle. 07 Affichage de Réglage Heure <ul style="list-style-type: none"> - Lorsque Timer mode économie d'énergie est activé. - Lorsque l'heure de Passer est activée. | <ul style="list-style-type: none"> 08 Indicateur de Prog. <ul style="list-style-type: none"> - Lorsqu'un Programmation est configuré. - Lorsqu'un Retour programmation est configuré. 09 Voyant de Nettoyage 10 Voyant de Verrouillage 11 Voyant de vérification 12 Voyant de Réinitialisation du filtre 13 Voyant de Dégivrage 14 Voyant de Commande centrale 15 Voyant de Température de sortie |
|---|--|

Ventilateur

- | | |
|--|---|
| <ul style="list-style-type: none"> 01 Affichage de la température actuelle 02 Affichage du mode de fonctionnement <ul style="list-style-type: none"> - Affiche n'importe laquelle de ces options : Récup, Auto, Dériv, Silence, et Absence. 03 Affichage de la vitesse du ventilateur <ul style="list-style-type: none"> - Affiche n'importe laquelle de ces options : Auto, Turbo, Grande, et Petite. 04 Indicateur de Prog. <ul style="list-style-type: none"> - Lorsqu'un Programmation est configuré. - Lorsqu'un Retour programmation est configuré. 05 Voyant de Verrouillage 06 Voyant de vérification | <ul style="list-style-type: none"> 07 Voyant de Réinitialisation du filtre 08 Voyant de Dégivrage 09 Voyant de Commande centrale 10 Voyant de Hotte (hotte d'évacuation) <p>REMARQUE</p> <ul style="list-style-type: none"> • Les fonctions indisponibles apparaissent inactives et ne peuvent être configurées. • L'emplacement des icônes peut différer selon la fonction. • Lorsque vous n'appuyez sur aucun bouton pendant 7 secondes, la fonction de la position est sélectionnée automatiquement. |
|--|---|

C Aperçu de l'écran de configuration

Appuyez sur le bouton  pour accéder à l'écran de configuration puis sélectionnez la fonction ou l'option souhaitée.

Air-conditionner

- | | |
|---|---|
| <ul style="list-style-type: none"> 01 Affichage Silence <ul style="list-style-type: none"> - Affiche la fonction Silence. 02 Affichage Nuit <ul style="list-style-type: none"> - Affiche la fonction Nuit. 03 Affichage Lg portée <ul style="list-style-type: none"> - Affiche la fonction Lg portée. 04 Affichage Prog. <ul style="list-style-type: none"> - Affiche n'importe laquelle de ces options : Minuteur, Programmation hebdo, Programmation annuelle, et Programmation Vacances. | <ul style="list-style-type: none"> 05 Affichage Nettoyage <ul style="list-style-type: none"> - Affiche la fonction Nettoyage. 06 Affichage Qualité air <ul style="list-style-type: none"> - Affiche la Qualité air. 07 Affichage Option <ul style="list-style-type: none"> - Affiche l'Option. 08 Affichage Énergie <ul style="list-style-type: none"> - Affiche n'importe laquelle de ces options : Conso. énergétique, Économie d'énergies, et Réglages énergétiques. |
|---|---|

Ventilateur

- | | |
|---|--|
| <ul style="list-style-type: none"> 01 Affichage Nettoyage <ul style="list-style-type: none"> - Affiche la fonction Nettoyage. 02 Affichage Éco énergie <ul style="list-style-type: none"> - Affiche la fonction Éco énergie. 03 Affichage Prog. <ul style="list-style-type: none"> - Affiche n'importe laquelle de ces options : Minuteur, Programmation hebdo, Programmation annuelle, et Programmation Vacances. 04 Affichage Option <ul style="list-style-type: none"> - Affiche l'Option. | <p>REMARQUE</p> <ul style="list-style-type: none"> • Les fonctions indisponibles apparaissent inactives et ne peuvent être configurées. • Dans le menu avec > dans le menu Option, vous pouvez sélectionner un menu au moyen du bouton >. • Lorsque vous n'appuyez sur aucun bouton pendant 180 secondes avec l'option active, les réglages ne sont pas enregistrés et l'écran d'accueil apparaît. |
|---|--|

vii

B Descrição geral do ecrã inicial

PT

Aparelho de ar condicionado

- | | | | |
|----|--|----|--|
| 01 | Visor da temperatura definida | 08 | Indicador Programação |
| 02 | Visor da temperatura atual | - | - Quando um Horário geral é definido. |
| 03 | Visor do modo de funcionamento | - | - Quando um Horário de vazio é definido. |
| - | - Exibe Auto, Arref., Desum., Vent e Aquec. | 09 | Indicador Limpar |
| 04 | Visor da velocidade da ventoinha | 10 | Indicador Bloquear |
| - | - Exibe Auto, Turbo, Alto, Médio e Baixo. | 11 | Indicador de verificação |
| 05 | Visor Wind-Free | 12 | Indicador Reiniciar filtro |
| 06 | Visor da direção do fluxo de ar | 13 | Indicador Descongelção |
| - | - Exibe Corrigir, Localizado, Médio, Disperso, Oscilação e Individual. | 14 | Indicador Controlo central |
| 07 | Visor Configuração da hora de início | 15 | Indicador Temperatura de insuflação |
| - | - Quando Temporizador de economia de energia é ativado. | | |
| - | - Quando o tempo Sobreposição é ativado. | | |

Ventilador

- | | | | |
|----|--|----|----------------------------|
| 01 | Visor da temperatura atual | 07 | Indicador Reiniciar filtro |
| 02 | Visor do modo de funcionamento | 08 | Indicador Descongelção |
| - | - Exibe Recup., Auto, By-Pass, Silencioso e Ausente. | 09 | Indicador Controlo central |
| 03 | Visor da velocidade da ventoinha | 10 | Indicador Exaustor |
| - | - Exibe Auto, Turbo, Alto e Baixo. | | |
| 04 | Indicador Programação | | |
| - | - Quando um Horário geral é definido. | | |
| - | - Quando um Horário de vazio é definido. | | |
| 05 | Indicador Bloquear | | |
| 06 | Indicador de verificação | | |
- NOTA**
- As funções indisponíveis estão marcadas como inativas e não podem ser definidas.
 - A localização dos ícones pode diferir consoante a função.
 - Se não premir qualquer botão durante 7 segundos, a função da posição é selecionada automaticamente.

C Descrição geral do ecrã de definições

Prima o botão  para entrar no ecrã de definições e, em seguida, selecione a função ou opção pretendida.

Aparelho de ar condicionado

- | | | | |
|----|---|----|---|
| 01 | Visor Silencioso | 05 | Visor Limpeza |
| - | - Exibe a função Silencioso. | - | - Exibe a função Limpeza. |
| 02 | Visor Noturno | 06 | Visor Qualidade ar |
| - | - Exibe a função Noturno. | - | - Exibe a Qualidade ar. |
| 03 | Visor Long Wind | 07 | Visor Opção |
| - | - Exibe a função Long Wind. | - | - Exibe a Opção. |
| 04 | Visor Program. | 08 | Visor Energia |
| - | - Exibe Temporizador, Programação semanal, Progr. anual e Def. Modo Férias. | - | - Exibe Utiliz. energia, Poupança energia e Definições energia. |

Ventilador

- | | | | |
|----|---|--|--|
| 01 | Visor Limpeza | | |
| - | - Exibe a função Limpeza. | | |
| 02 | Visor P. energia | | |
| - | - Exibe a função P. energia. | | |
| 03 | Visor Program. | | |
| - | - Exibe Temporizador, Programação semanal, Progr. anual e Def. Modo Férias. | | |
| 04 | Visor Opção | | |
| - | - Exibe a Opção. | | |
- NOTA**
- As funções indisponíveis estão marcadas como inativas e não podem ser definidas.
 - No menu com o > no menu Opção, pode selecionar um menu com o botão >.
 - Se não premir qualquer botão durante 180 segundos com a opção ativa, as definições não são guardadas e aparece o ecrã inicial.

viii

Contents

Safety Information	3
Safety Information	3
Power Smart Features	5
Remote Controller Operation	5
Operation modes • Controlling temperature • Controlling fan speed	5
Controlling air flow direction	6
Cooling Operation	7
Cool mode • Wind-Free function	7
Dehumidifying Operation	8
Dry mode	8
Air Purifying Operation	8
Purify function	8
Heating Operation	9
Heat mode	9
Quick Smart Features	9
Auto mode • Fan mode	9
Quiet function • Sleep function • Long Wind function	10
Ventilation (ERV) Operation	11
Ventilation (ERV) Operation	11
Operation modes • Controlling fan speed	11
E-Saver function • Clean up function	12
Energy-Saving Operation	13
Energy-Saving Operation	13
Schedule	13
Energy	14
Setting Options	15
Setting Options	15
How to set the Options	15
Current Time Setting (Example)	17

Safety Information

California Proposition 65 Warning (US)

 **WARNING:** Cancer and Reproductive Harm - www.P65Warnings.ca.gov.





This content is intended to protect the user's safety and prevent property damage. Please read it carefully for correct use of the product.

 **WARNING**

Hazards or unsafe practices that may result in severe personal injury or death.



 **CAUTION**

Hazards or unsafe practices that may result in minor personal injury or property damage.

- | | |
|--|---|
|  Follow directions. |  Do NOT attempt. |
|  Make sure the machine is grounded to prevent electric shock. | |
|  Unplug the appliance. |  Do NOT disassemble. |

FOR INSTALLATION

 **WARNING**

-  The installation of this appliance must be performed by a qualified technician or service company.
 - Failing to do so may result in electric shock, fire, explosion, problems with the product, or injury.
 You must connect the product with rated power upon installation.
 - Failing to do so may result in problems with the product, electric shock, or fire.
-  Do not install this appliance near a heater, inflammable material. Do not install this appliance in a humid, oily or dusty location, in a location exposed to direct sunlight and water (rain drops). Do not install this appliance in a location where gas may leak.
 - Failing to do so may result in electric shock or fire.

 **CAUTION**

-  Install the product on a hard and even place that can support its weight.
 - If the place cannot support its weight, the product may fall down and it may cause product damage.

FOR POWER SUPPLY

 **WARNING**

-  Do not bend or pull the power cord excessively. Do not twist or tie up the power cord.
 - Failing to do so may result in electric shock or fire.

Safety Information

FOR OPERATION

WARNING

 If the appliance generates a strange noise, a burning smell or smoke, unplug the product immediately and contact your nearest service centre.

- Failing to do so may result in electric shock or fire.

To reinstall the air conditioner, please contact your nearest service centre.

- Failing to do so may result in problems with the product, water leakage, electric shock, or fire.
- A delivery service for the product is not provided. If you reinstall the product in another location, additional construction expenses and an installation fee will be charged.

If the malfunction diagnosis indicator appears or malfunctions, then stop operation immediately.

- If you detect any burning smells from the product or it malfunctions, then immediately turn off the air conditioner/Ventilator(ERV) and power, and then contact the service centre. Continuing to use the device in this state can cause electrical shock, fire, or damage to the product.
- If the E836 indicator appears, then it means that it is time to contact the service centre for periodic inspection. Neglecting these periodic inspections can result in malfunctions (only applicable to GHP model).

 Do not attempt to repair, disassemble, or modify the product yourself.

- Failing to do so may result in electric shock, fire, product malfunction, or injury.

CAUTION

 Do not allow water to enter the product.

- Failing to do so may result in fire or explosion.

 Do not operate the product with wet hands.

- Failing to do so may result in electric shock.

Do not spray volatile material such as insecticide onto the surface of the product.

- As well as being harmful to humans, it may also result in electric shock, fire, or product malfunction.

Do not give a strong impact to the product and do not disassemble the product.

Do not use this product for other purposes.

- This product is designed to be used only for a system air conditioner.

Do not press the buttons with any sharp objects.

- Failing to do so may result in electric shock or part damage.

FOR CLEANING

WARNING

 Do not clean the product by spraying water directly onto it. Do not use benzene, thinner, alcohol or acetone to clean the product.

- Failing to do so may result in discoloration, deformation, damage, electric shock, or fire.

Remote Controller Operation

You can use the air conditioner easily by selecting a mode and then by controlling the temperature, fan speed, and air flow direction.

Use the \langle and \rangle buttons to select the desired menu, press the **OK** button, use the \wedge , \vee buttons to select the desired item, and then press the **OK** button.

Operation modes

You can change the current mode to Auto, Cool, Dry, Fan, and Heat.

Controlling temperature

You can control the temperature in each mode as follows:











Mode	Temperature control
Auto/Cool/Dry	Adjust by 1 °C (1 °F) between 18 °C (65 °F) and 30 °C (86 °F).
Fan	You cannot control the temperature.
Heat	Adjust by 1 °C (1 °F) between 16 °C (61 °F) and 30 °C (86 °F).

 **NOTE**

- The set temperature range available on the remote controller may change depending on the set temperature range that indoor unit supports.

Controlling fan speed

You can select the following fan speeds in each mode:

Mode	Available fan speeds
Auto/Dry	 AUTO Auto
Cool/Heat	 AUTO Auto,  Turbo,  High,  Medium,  Low
Fan	 Turbo,  High,  Medium,  Low

 **NOTE**

-  Turbo appears active only on the indoor unit that supports the Turbo fan speed.

PowerSmart Features

Power Smart Features

Remote Controller Operation

Controlling air flow direction

You can control air flow direction.

General models	☰ Fix, ⇨ Swing, ⇩ Swing, ⇩⇨ Swing, ⇩⇨ Individual
360 cassette model	⇩⇩ Spot, ⇩⇨ Mid, ⇩⇨ Wide, ⇩⇨ Swing 360, ⇩⇨ Individual

- For 360-cassette indoor unit

Mode	Wired remote controller display	Indoor unit indicator
Spot	⇩⇩ Spot	○
Mid	⇩⇨ Mid	○
Wide	⇩⇨ Wide	○
Swing	⇩⇨ Swing 360	○→○→○→○

- If 360-cassette indoor units and other indoor units are installed together, the air flow direction does not change on the indoor units other than 360-cassette when Spot, Mid, or Wide is started as the air flow direction.
- You can select individual air flow direction for each blade, when the individual indication appears active on the indoor unit that supports this mode.

NOTE

- The displayed flow direction icon may differ depending on the indoor model.
- The current air flow direction persists even if you change the current mode, or turn off and then turn on the remote controller.
- Blades that can be selected for Individual may differ depending on the product model.
- When Blade lock is set, the locked blade appears inactive.

Cooling Operation

The smart and powerful cooling functions of the Samsung air conditioner keep an enclosed space cool and comfortable.

Cool mode

Use the Cool mode to stay cool in hot weather.

 NOTE

- It is recommended to set the desired temperature between 24 °C (75 °F) and 26 °C (79 °F).
- To cool your room quickly, select a low temperature and a high fan speed.
- To save energy, select a high temperature and a low fan speed.
- As the indoor temperature approaches the set temperature, the compressor will operate at a low speed to save energy.

Wind-Free function

Use the Wind-Free function to enjoy mild cool breeze exuding from fine holes on the Wind-Free panel with the air flow blade closed, instead of getting cool wind directly. The automated control of the temperature and fan speed according to the indoor temperatures keeps your room cool and pleasant.

 NOTE

- If the Wind-Free function is cancelled, the air conditioner returns to the previous fan speed.
- You can adjust the set temperature during the Wind-Free function, and recommended set temperatures are 24 to 26 °C (75 to 79 °F). However, you cannot change the set temperature in the Fan mode.
- You can use the Wind-Free function when the Cool, Dry, or Fan mode is running.
- If the room temperature increases because of rise of external temperature, heat from cooking, or other reason, operate normal cooling first to lower the temperature, before operating Wind-Free to keep the desired temperature.
- If you select the Wind-Free function in the Fan mode, the compressor stops working so that cool air does not come out. However, mild breeze comes out and starts to clean the air in the room.
- During the Wind-Free operation, the cold air may be intermittently weakened depending on the temperature and humidity in the room. But the wind-free air currents are maintained and the weakened cold air is immediately recovered, consequently keeping the room comfortable. (During the Wind-Free operation, the air flow blades may open to control the indoor air condition smoothly, depending on the installation settings. In this case, as soon as the indoor temperature and humidity change, the air flow blades are closed and the Wind-Free operation restarts. For more information on the installation settings, see "Setting the indoor unit addresses and the installation options" in the installation manual of the indoor unit.)

Change of the air flow blade by temperature and humidity			
Indoor temperature and humidity	Low	High	
		Breeze is blown via the micro holes on the air flow blades	Breeze is blown via the micro holes on the air flow blades
Air flow blade	Closed	Closed (default)	Opened (according to setting)

- When the Wind-Free function runs while sleeping, you may feel cold air if the air conditioner is installed over the bed. In this case, set the desired temperature higher than the normal setting temperature.

Dehumidifying Operation

The dehumidifying function of the Samsung air conditioner keeps an enclosed space dry and comfortable.

Dry mode

Use the Dry mode in rainy or humid weather.

NOTE

- You cannot change fan speed in the Dry mode.
- The greater the difference between room temperature and set temperature, the longer the needed time to dehumidify the air is.

Air Purifying Operation

The air purification function of the Samsung air conditioner keeps the air in an enclosed space purified.

Purify function

Use the Purify function to remove harmful materials in the air to provide you a clean and healthy environment.

This function is available in the Auto, Cool, Dry, Fan, and Heat modes.

NOTE

- During the Air Purifying operation, dust is collected on the active filter panel.
- When the Purify function is additionally selected in the Fan mode, you cannot change the set temperature.
- When the Purify function is additionally selected while a specific mode is running, there is little difference in electricity consumption and operating noise.

Air purity level indications

- The indications are displayed only on the models that support the air purity level display function.
- The air purity levels for PM10, PM2.5, and PM1.0 appear as follows:

Purity level	PM10		PM2.5/PM1.0	
	Colour	Concentration (μm^3)	Colour	Concentration (μm^3)
Very Poor	Red	151 or more	Red	76 or more
Poor	Yellow	81-150	Yellow	36-75
Normal	Green	31-80	Green	16-35
Good	Blue	30 or less	Blue	15 or less

- When you set Air Quality to ON, the screen saver displays the current air purity level details.
 - You can set the screen saver launch time in Option > User mode.
- Air purity level can only be displayed on indoor units supporting this function.

Heating Operation

The heating functions of the Samsung air conditioner keep an enclosed space warm and comfortable.

Heat mode

Use the Heat mode to stay warm.

NOTE

- While the air conditioner warms up, the fan may not operate for a while at the beginning to prevent cold wind.
- If the outdoor temperature is low and the humidity is high while the Heat mode is running, the heating performance of the air conditioner may decrease due to frost or ice that forms on the outdoor heat exchanger. When this condition happens, the air conditioner runs the Defrost function for about 5 to 12 minutes to remove the frost and ice, both water and steam are released from the outdoor unit.
- While the Defrost function is running, the indoor unit provides no breeze to prevent cold wind.
- The operation time of the Defrost function varies depending on the amount of the frost and ice and the humidity.
- While the Defrost function is running, none of other functions will work, even if you select them on the remote controller.

Quick Smart Features

There is a variety of useful functionality provided by the Samsung air conditioner.

Auto mode

Use the Auto mode when you want the air conditioner to automatically control the mode (Heat or Cool). The air conditioner will provide the most comfortable atmosphere that it can.

NOTE

- You cannot change the fan speed.
- While the Cool mode is running, the air conditioner produces a strong cold air if there is a large difference between the set temperature and the current temperature. When the temperature difference becomes small, the air conditioner automatically changes the air flow direction and keeps the room at a comfortable temperature.

Fan mode

Use the Fan mode to run the air conditioner like a common fan. The air conditioner provides a natural breeze.

NOTE

- If the air conditioner will not be used for an extended period of time, dry the air conditioner by running it in the Fan mode between 3 and 4 hours.

Quick Smart Features

Quiet function

Quiet function decreases the operation sound in the Auto, Cool, Dry, or Heat mode.

 NOTE

- You can control the set temperature, fan speed, and air flow direction.
- When you select Quiet in Wind-Free or Long Wind function, the previous function is cancelled.

Sleep function

Sleep function automatically turns off the air conditioner after 6 hours without stopping the operation in the middle of the night.

 NOTE

- You can select this function only in the Cool and Heat modes.
- You can control the set temperature, fan speed, and air flow direction.
- When you select Sleep in Wind-Free or Long Wind function, the previous function is cancelled.

Long Wind function

Use the Long Wind function to quickly deliver a long reaching air flow.

 NOTE

- You can select this function only in the Cool, Dry, and Fan modes.
- You cannot control the fan speed and air flow direction.
- When you select Long Wind in the Wind-Free, Quiet, or Sleep function, the previous function is cancelled.

Ventilation (ERV) Operation

Operation modes

You can select the desired mode.

Mode	Description
Heat-EX	This mode minimizes energy loss by recovering energy from the exhaust air during indoor heating or cooling.
Auto	This mode automatically adjusts the ventilation functions depending on the degree of pollution in your indoor air.
By-Pass	This mode activates the intake of external air so that it comes indoors.
Quiet	This mode reduces the sound produced by the ventilator (ERV).
Away	This mode allows you to operate the ventilator (ERV) while you are away from home.

 NOTE

- Only when you select all the options of ventilator (ERV), you can use the above operation. (Only available when the wired remote controller is installed)
- If the operation status is changed by another controller, the operation mode is cancelled.

Controlling fan speed

You can select the following fan speeds in each mode:

Heat-EX/Auto/ By-Pass	 Auto,  Turbo,  High,  Medium
Quiet/Away	 Medium

 NOTE

-  Auto appears active only on the ventilator that supports the Auto fan speed.

Ventilation (ERV) Operation

E-Saver function

Reduce your power consumption and save money on your electric bill.

- When the ventilator (ERV) and the air conditioner is connected together
 - This function compares the outdoor and indoor temperatures, and then automatically selects Heat-EX or By-Pass operation.
- When the ventilator (ERV) is installed separately (depending on the option settings at installation), it operates as follows:

ON/OFF Alternation operation	<ul style="list-style-type: none"> • The ventilator (ERV) turns On and Off in Quiet (Medium) mode every 30 minutes.
Outdoor air cooling operation for different temp. setting	<ul style="list-style-type: none"> • Operates when the View Master is for ERV+. • With the temperature control button, the default temperature for E-Saver can be set. • Depending on the set temperature, it automatically selects Heat-EX or By-Pass operation.

NOTE

- When the air conditioner is connected individually, E-Saver function is not available.

Clean up function

Prevent odor and dust from entering by making the airflow input bigger than the airflow output.

Energy-Saving Operation

The Samsung air conditioner provides functions that allow you to reduce electricity consumption.

Schedule

Press the  button, press the   or  button to select Schedule, and then press the **OK** button.

You can set each of General Schedule, Setback Schedule, Override, Energy Saving Timer, Eco Setting, and Activation Time Setting.

Type	Description
General Schedule	Timer <ul style="list-style-type: none"> • Turns the device on or off after a set time. <ul style="list-style-type: none"> – You can set the timer by 5 minute increments.
	Weekly schedule <ul style="list-style-type: none"> • Schedules the operation of the device on a set day and at a set time. <ul style="list-style-type: none"> – You can schedule on the weekly basis. You can also set the values for day, time, operation on/off, scheduled device, and operation status (operation mode, set temperature, fan speed).
	Yearly schedule <ul style="list-style-type: none"> • Creates groups for the desired months for scheduling <ul style="list-style-type: none"> – You can schedule up to 8 groups on the yearly basis.
	Holiday <ul style="list-style-type: none"> • Allows you not to make use of the schedule on holidays.
Setback Schedule	<ul style="list-style-type: none"> • Controls the indoor unit with 4 different operation patterns. <ul style="list-style-type: none"> – Each pattern sets the values for time, operation (OFF, Cool, Heat, Auto), and the set temperature.
Override	Allows you to run at a specific time the operation you set using Energy Saving Timer.
Energy Saving Timer	<ul style="list-style-type: none"> • When set to "Turn off" <ul style="list-style-type: none"> – If the indoor unit is turned on, the indoor unit turns off after the set time elapses. • When set to "Eco Setting" <ul style="list-style-type: none"> – If the current temperature continues to differ from the reference cooling or heating temperature set in Eco Setting, the indoor unit returns to the temperature set in Eco Setting after the set time elapses. • When set to "Setback Schedule" <ul style="list-style-type: none"> – If the most recently operated Setback Schedule status differs from the indoor unit status, the indoor unit returns to that Setback Schedule status after the set time elapses. <p>※ When "Timer Reset" is set to "Enable", the set time is re-counted if the indoor unit status changes.</p> <p>※ When a period of time is set in Activation Time Setting, the indoor unit only operates for that period of time.</p>





Energy-Saving Operation

Type	Description
Eco Setting	Allows you to set the reference cooling and heating temperatures when "Energy Saving Timer" is set to "Eco Setting".
Activation Time Setting	Allows you to make the Energy Saving Timer function operate only for the period of time you set.

NOTE

- Weekly schedule and Yearly schedule can cover settings up to 49.

Energy





Press the  button, press the   or  button to select Energy, and then press the **OK** button. You can see and set any of Energy Usage and Energy Setting.

Classification	Type	Description
Energy Usage	-	Displays the Instantaneous Power, Weekly Energy Usage, Monthly Energy Usage, Yearly Energy Usage, Energy Usage over Last Year, and Operation Time in graph format. NOTE <ul style="list-style-type: none"> For accuracy of operation time, use the DMS time synchronization. The weekly display follows the ISO 8601 standards.
Energy Setting	Set Outdoor Capacity	Controls the outdoor unit's operation capacity.
	Target Energy Consumption	Sets the target energy consumption.
	Target Operation Time	Sets the target operation time.
	Alarm Popup	Sets whether or not to generate an alarm when the target energy consumption is reached.
	Usage Data Initialization	Initialises the entire energy function.

Energy-Saving Operation

Setting Options

How to set the Options

- 1 Press the  button.
- 2 Press the   or  button to select Option, and then press the **OK** button.
- 3 See the following pages to select the desired menu.

Major	Step1	Step2	Step3	Step4	Step5	Description	Default		
General	Button lock					ON/OFF	-		
	Filter reset	Indoor					-		
		Ventilator					-		
	Error list						-		
Indoor unit information						-			
Indoor	Blade selection					4-way cassette: Swing ON/Swing OFF 360 cassette: Spot/Mid/Wide	-		
	Motion detect sensor	Set Motion detect sensor				ON/OFF	OFF		
		Motion detection type				Indirect Wind/Direct Wind	Indirect Wind		
Option	User mode	Language				Differs depending on the language	First value for the language pack		
		Daylight Savings Time	Daylight Savings Time				ON/OFF	ON	
			Unit				Day/Week	Week	
			Week	Start Month				January to December	Mar
				Start Week				1st to 4th, Final (final week)	2nd
				End Month				January to December	Nov
				End Week				1st to 4th, Final (final week)	1st
			Day	Start Month				January to December	Mar
				Start Day				1-31	22
		End Month					January to December	Sep	
		End Day					1-31	22	
		Air Purify Display	PM10				ON/OFF	ON	
			PM2.5				ON/OFF	ON	
PM1.0					ON/OFF	OFF			

Setting Options

Setting Options

Major	Step1	Step2	Step3	Step4	Step5	Description	Default		
Option	User mode	Lock	All lock			ON/OFF	OFF		
			Partial Lock Fuction	Operation Lock			ON/OFF	OFF	
				Operation mode Lock	All mode Lock			ON/OFF	OFF
					Auto mode Lock			ON/OFF	OFF
					Cool mode Lock			ON/OFF	OFF
					Dry mode Lock			ON/OFF	OFF
					Heat mode Lock			ON/OFF	OFF
				Fan mode Lock			ON/OFF	OFF	
				Temperature Lock			ON/OFF	OFF	
				Fan speed Lock			ON/OFF	OFF	
				Additional Mode Lock	Wind-Free Lock			ON/OFF	OFF
			Long Wind Lock				ON/OFF	OFF	
			Quiet Lock				ON/OFF	OFF	
			Schedule Lock			ON/OFF	OFF		
		Wired remote controller	LED			ON/OFF	ON		
			Button Mute			ON/OFF	OFF		
			Wireless remote controller			ON/OFF	OFF		
			Current time	Date			2000 to 2099/1 to 12/1 to 31	2018.01.01.	
				Time			12-Hour/24-hour 12-hour format : 1 to 12, 24-hour format: 0 to 23, minutes: 00 to 59	12:00 PM	
			Reset remote controller			-	-		
			Display setting	Brightness			10 to 100%	100%	
				Screen saver	Timer			10 to 60 seconds	30 sec
					Brightness			0, 10, 30, 50, 70%	30%
			Smart Reset					-	
			Reset All User modes					-	



















Setting Options

Major	Step1	Step2	Step3	Step4	Step5	Description	Default	
Option	User mode	Auto changeover	Use of wired remote controller DSP			ON/OFF	ON	
			Cooling Set temp./Heating Set temp.			18°C to 30°C (Set temp range for auto operation of the indoor unit)	Indoor unit status value	
			Primary			0.5°C to 2°C(or 1°F to 4°F)	Indoor unit status value	
			Secondary			0.5°C to 2°C(or 1°F to 4°F)	Indoor unit status value	
		Temperature limits	Lower Limit			Celsius: 8 to 30°C Fahrenheit: 47 to 86°F	8°C	
			Upper Limit			Celsius: 8 to 30°C Fahrenheit: 47 to 86°F	30°C	
		Easy tuning				-2 to +2	0	
		Indoor lighting				ON/OFF	Indoor unit status value	
		Clean				ON/OFF	Indoor unit status value	
		Delay time	Use of ERV delay time				ON/OFF	OFF
			ERV delay time				30 to 60 minutes	30

 NOTE

- When two wired remote controllers are connected, the brightness can be set within 10 to 50%.

Current Time Setting (Example)

- 1 Press the  button.
- 2 Press the   or  button to select Option, and then press the **OK** button.
- 3 Press the   or  button to select User mode, and then press the **OK** button.
- 4 Press the   or  button to select Wired remote controller, and then press the **OK** button.
- 5 Press the   or  button to select Current time, and then press the **OK** button.
- 6 Press the   or  button to select Time, and then press the **OK** button.
- 7 Press the   or  button to select Time format, Hour, Minute, and AM/PM, and then press the **OK** button.

Memo

Setting Options

18 English



Setting Options

SAMSUNG

Air conditioner

User manual

AR**BSFC***

- Thank you for purchasing this Samsung air conditioner.
- Before operating this unit, please read this user manual carefully and retain it for future reference.



SAMSUNG

Contents

Safety Information	4
Safety Information	4
At a Glance	11
Indoor Unit Overview	11
Display	12
Remote Control Overview	13
Replacing the remote control batteries	13
Remote Control Operation	14
Selecting an operation mode	14
To set the temperature • To adjust the fan speed • To adjust the airflow direction	15
Setting the Current time	16
Smart Features	17
Power Smart Features	17
WindFree Cooling function	17
AI Auto mode	18
Auto mode • Cool mode	19
Dry mode • Fan mode	20
Heat mode • Automatic defrost	21
Variety Smart Features	22
Fast function	22
Eco function	23
Quiet function • Electricity consumption check	24
Usage time check • Beep function	25
Auto clean function	26
Display lighting function • Wi-Fi function (SmartThings app)	28
Time scheduling	29
Timed on/ Timed off function	29
good'sleep function	30

Cleaning and Maintenance	31
Schedule	31
Cleaning	32
Appendix	35
Troubleshooting	35
SmartThings app	37

Safety Information

WARNING: Read This Manual

Read and follow all safety information and instructions before installation, use, or maintenance of this appliance. Incorrect installation, use, or maintenance of this appliance can result in death, serious injury, or property damage. Keep these instructions with this appliance. This manual is subject to change. For the latest version, www.samsunghvac.com.

Because the instructions in this manual cover various models, the characteristics of your air conditioner may differ slightly from those described. If you have any questions, please contact your service provider or visit www.samsunghvac.com.

This device complies with Industry Canada license exempt RSS standard(s). Operation is subject to the following two conditions: (1) this device may not cause harmful interference and (2) this device must accept any interference received, including interference that may cause undesired operation. This Class B digital apparatus complies with Canadian ICES-003.

ENERGY STAR qualified model only

- Proper sizing and installation of equipment is critical to achieve optimal performance. Split system air conditioners and heat pumps (excluding ductless systems) must be matched with appropriate coil components to meet ENERGY STAR criteria. Ask your contractor for details or visit www.energystar.gov.



Qualified model list (Indoor/Outdoor):

- AR09BSFCMWKN/AR09BSFCMWKX

Notices and notes

To make you aware of safety messages and highlighted information, we use the following notices and notes throughout this manual:

WARNING

Hazards or unsafe practices that may result in severe personal injury or death.

CAUTION

Hazards or unsafe practices that may result in minor personal injury or property damage.

IMPORTANT

Information of special interest

NOTE

Supplementary information that may be useful

FOR GENERAL

California Proposition 65 Warning (US)

 **WARNING:** Cancer and Reproductive Harm - www.P65Warnings.ca.gov.

FOR INSTALLATION

 **WARNING**

Use a power cord with this product's power specifications or higher and use the power cord for this appliance only. In addition, do not use an extension cord.

- Extending the power cord may result in electric shock or fire.
- Do not use an electric transformer. This may result in electric shock or fire.
- If the voltage/frequency/rated current condition is different, it may cause fire.

The installation of this appliance must be performed by a qualified technician or service company.

- Failing to do so may result in electric shock, fire, explosion, problems with the product, or injury and may also void warranty on the installed product.

Install an Isolation Switch next to the Air Conditioner (but not on the panels of the Air Conditioner) and circuit breaker dedicated to the air conditioner.

- Failing to do so may result in electric shock or fire.

Safety Information

Fix the outdoor unit firmly so that the electric part of the outdoor unit is not exposed.

- Failing to do so may result in electric shock, fire, explosion, or problems with the product.

Do not install this appliance near a heater, or inflammable material. Do not install this appliance in a humid, oily or dusty location, in a location exposed to direct sunlight and water (or rain). Do not install this appliance in a location where gas may leak.

- This may result in electric shock or fire.

Never install the outdoor unit in a location such as on a high external wall where it could fall.

- If the outdoor unit falls, it may result in injury, death or property damage.

This appliance must be properly grounded. Do not ground the appliance to a gas pipe, plastic, water pipe, or telephone line.

- Failing to do so may result in electric shock, fire, and explosion.
- Make sure to use a socket-outlet with ground.



CAUTION

Install your appliance on a level and hard floor that can support its weight.

- Failing to do so may result in abnormal vibrations, noise, or problems with the product.

Install the drain hose properly so that water drains correctly.

- Failing to do so may result in water overflowing and property damage. Avoid adding drain to waste pipes as odours may arise in the future.

When installing the outdoor unit, make sure to connect the drain hose so that draining is performed correctly.

- The water generated during heating by the outdoor unit may overflow and result in property damage.
In particular, in winter, if a block of ice falls, it may result in injury, death or property damage.

Do not install the product in a place where thermo-hygrostat is needed (such as server room, machinery room, computer room, etc.)

- Those places do not provide guaranteed operation condition of the product therefore performance can be poor in these places.

FOR POWER SUPPLY

**WARNING**

When the circuit breaker is damaged, contact a qualified installer or HVAC service company.

Do not pull or excessively bend the power line. Do not twist or tie the power line. Do not hook the power line over a metal object, place a heavy object on the power line, insert the power line between objects, or push the power line into the space behind the appliance.

- This may result in electric shock or fire.

If the supply cord is damaged, it must be replaced by the manufacturer, its service agent or similarly qualified persons in order to avoid a hazard.

**CAUTION**

When not using the air conditioner for a long period of time or during a thunder/lightning storm, cut the power at the circuit breaker.

- Failing to do so may result in electric shock or fire.

FOR USING

**WARNING**

If the appliance is flooded, please contact a qualified installer or HVAC service company.

- Failing to do so may result in electric shock or fire.

If the appliance generates a strange noise, a burning smell or smoke, cut off the power supply immediately and contact a qualified installer or HVAC service company.

- Failing to do so may result in electric shock or fire.

In the event of a gas leak (such as propane gas, LP gas, etc.), ventilate immediately without touching the power line. Do not touch the appliance or power line.

- Do not use a ventilating fan.
- A spark may result in an explosion or fire.

Safety Information

To reinstall the air conditioner, please contact a qualified installer or HVAC service company.

- Failing to do so may result in problems with the product, water leakage, electric shock, or fire.
- Delivery service for the product is not provided. If you reinstall the product in another location, additional construction expenses and an installation fee will be charged.
- Especially, when you wish to install the product in an unusual location such as in an industrial area or near the seaside where it is exposed to salt in the air, please contact a qualified installer or HVAC service company.

Do not touch the circuit breaker with wet hands.

- This may result in electric shock.

Do not turn the air conditioner off with the circuit breaker while it is operating.

- Turning the air conditioner off and then on again with the circuit breaker may cause a spark and result in electric shock or fire.

After unpacking the air conditioner, keep all packaging materials well out of the reach of children, as packaging materials can be dangerous to children.

- If a child places a bag over its head, it may result in suffocation.

Do not touch the airflow blade with your hands or fingers during heating.

- This may result in electric shock or burns.

Do not insert your fingers or foreign substances into the air inlet/outlet of the air conditioner.

- Take special care that children do not injure themselves by inserting their fingers into the product.

Do not strike or pull the air conditioner with excessive force.

- This may result in fire, injury, or problems with the product.

Do not place an object near the outdoor unit that allows children to climb onto the machine.

- This may result in children seriously injuring themselves.

Do not use this air conditioner for long periods of time in badly ventilated locations or near infirm people.

- Since this may be dangerous due to a lack of oxygen, open a window at least once an hour.

If any foreign substance such as water has entered the appliance, cut off the power supply and contact a qualified installer or HVAC service company.

- Failing to do so may result in electric shock or fire.

Do not attempt to repair, disassemble, or modify the appliance yourself.

- Do not use any fuse (such as copper, steel wire, etc.) other than the standard fuse.
- Failing to do so may result in electric shock, fire, problems with the product, or injury.

 **CAUTION**

Do not place objects or devices under the indoor unit.

- Water dripping from the indoor unit may result in fire or property damage.

Check that the installation frame of the outdoor unit is not broken at least once a year.

- Failing to do so may result in injury, death or property damage.

To prevent personal injury, make sure that you change the directions of the horizontal airflowblades after stopping the movements of the vertical airflowblade. (In case of adjusting the horizontal airflow manually)

Do not install the product in a ship or a vehicle (such as a campervan).

- Salt, vibration or other environmental factor may cause the product malfunction, electric shock or fire.

Do not stand on top of the appliance or place objects (such as laundry, lighted candles, lighted cigarettes, dishes, chemicals, metal objects, etc.) on the appliance.

- This may result in electric shock, fire, problems with the product, or injury.

Do not operate the appliance with wet hands.

- This may result in electric shock.

Do not spray volatile material such as insecticide onto the surface of the appliance.

- As well as being harmful to humans, it may also result in electric shock, fire or problems with the product.

Do not drink the water from the air conditioner.

- The water may be harmful to humans.

Do not hit, shake, drop, or attempt to disassemble the remote control.

When replacing the remote control batteries, keep them out of the reach of infants.

- If an infant eats batteries, contact a doctor immediately.

When replacing the remote control batteries, be careful not to get the battery fluid on your skin.

- Battery fluid is harmful to humans.

Safety Information

Do not touch the pipes connected with the product.

- This may result in burns or injury.

Do not use this air conditioner to preserve precision equipment, food, animals, plants or cosmetics, or for any other unusual purposes.

- This may result in property damage.

Avoid directly exposing humans, animals or plants to the airflow from the air conditioner for long periods of time.

- This may result in harm to humans, animals or plants.

FOR CLEANING



WARNING

Do not clean the appliance by spraying water directly onto it. Do not use benzene, thinner or alcohol to clean the appliance.

- This may result in discolouration, deformation, damage, electric shock or fire.

Before cleaning or performing maintenance, cut off the power supply and wait until the fan stops.

- Failing to do so may result in electric shock or fire.



CAUTION

Take care when cleaning the surface of the heat exchanger of the outdoor unit since it has sharp edges.

- This should be done by a qualified technician. Please contact a qualified installer or HVAC service company.

Do not clean the inside of the air conditioner by yourself.

- For cleaning inside the appliance, contact a qualified installer or HVAC service company.
- When cleaning the filter, refer to the descriptions in the 'Cleaning' section.
- Failing to do so may result in damage, electric shock or fire.
- Make sure to prevent any injury from sharp edges of the surface when handling the heat exchanger.

Indoor Unit Overview

The appearance of the actual product may differ slightly from the image below.

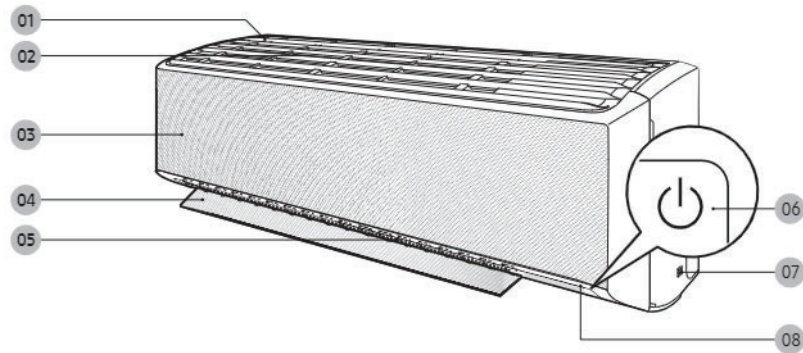

- 01 Air intake
- 02 Air filter
- 03 WindFree panel
- 04 Airflow blade (up and down)

- 05 Airflow blade (left and right)
- 06 Power button/Remote control receiver
- 07 Room temperature sensor
- 08 Display

At a Glance

Indoor Unit Overview

Display

At a Glance

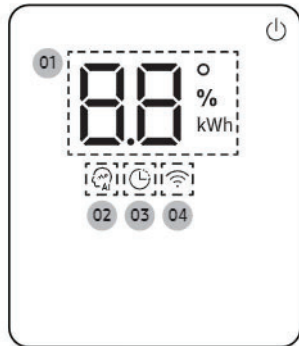

- 01 Temperature indicator (numeric)
Filter reset indicator (CF)
Electricity consumption indicator (numeric)
Auto clean indicator (CF) 
Defrost indicator (dF)
- 02 AI Auto indicator
- 03 Timer indicator
good'sleep indicator
- 04 Wi-Fi indicator

 **NOTE**

- When the Wi-Fi is turned on, the indicator blinks three times and then turn on.

 **NOTE**

- If the Wi-Fi indicator blinks for 10 seconds when operation starts, it means that the air conditioner is not connected to Wi-Fi. See "SmartThings app" on page 37 and connect the air conditioner to Wi-Fi.
- When connected to Wi-Fi, the air conditioner can gather and learn your user patterns so that it can run in AI Auto mode.

Remote Control Overview

Most operating instructions in this manual require using the remote control.

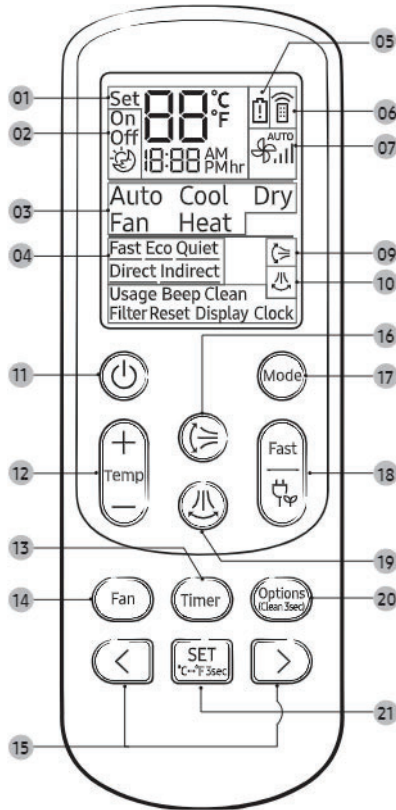

- 01 Set temperature indicator
- 02 Timer option indicator
- 03 Operation mode indicator
- 04 Options indicator
- 05 Low battery indicator
- 06 Transmit indicator
- 07 Fan speed indicator
- 08 WindFree indicator
- 09 Vertical air swing indicator
- 10 Horizontal air swing indicator
- 11 Power button
- 12 Temperature button
- 13 Timer button
- 14 Fan speed button
- 15 Direction button/Selection button
- 16 Vertical air swing button
- 17 Mode button
- 18 Fast/WindFree button
- 19 Horizontal air swing button
- 20 Options/Clean button
- 21 SET button/Temperature type button(°C↔°F)

At a Glance

NOTE

- Although Purify, Direct and Indirect appear on the remote control display, they are not available on this model.

Replacing the remote control batteries

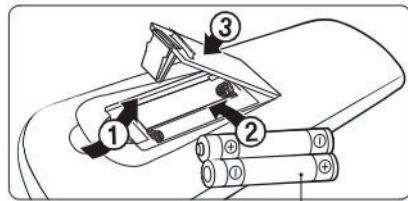

Two 1.5V AAA batteries

Remote Control Operation

You can use the air conditioner easily by selecting a mode and then by controlling the temperature, fan speed, and air direction.

At a Glance



Selecting an operation mode

To change the current mode between Auto, Cool, Dry, Fan, and Heat, press the **(Mode)** (Mode) button.

You can use AI Auto mode after Wi-Fi is connected.

NOTE

You can use the Cool, Dry, and Heat modes in the following operation range.

Mode	Cool	Dry	Heat
Indoor temperature	61 °F to 90 °F (16 °C to 32 °C)	65 °F to 90 °F (18 °C to 32 °C)	81 °F or less (27 °C or less)
Outdoor temperature	14 °F to 115 °F (-10 °C to 46 °C)	14 °F to 115 °F (-10 °C to 46 °C)	-5.1 °F to 76 °F ¹⁾ (-20.6 °C to 24 °C)
Indoor humidity	Relative humidity of 80 % or less ²⁾	-	-

¹⁾ If the outdoor temperature drops to -5.1 °F (-20.6 °C), the heating capacity may decrease by as much as 60-70 %.

²⁾ If the air conditioner operates in Cool mode in a high-humidity environment for an extended period of time, condensation may occur.

You can switch between Celsius and Fahrenheit indications on the remote control.

SET ^{°C-°F 3sec} ► Press and hold for 3 or more seconds.

NOTE

- The temperature indications on the indoor unit are not switched.
- This function is canceled when the remote control batteries are replaced. In this case, run this function again.



To set the temperature

To control the temperature in each mode, press the (Temperature) button:

Mode	Temperature control
AI Auto/Auto/Cool	Adjust by 1 °F from 61 °F to 86 °F (16 °C to 30 °C).
Heat	Adjust by 1 °F from 47 °F to 86 °F (8 °C to 30 °C).
Dry	Adjust by 1 °F from 65 °F to 86 °F (18 °C to 30 °C).
Fan	No temperature control.

To adjust the fan speed

Select from the following fan speeds in each mode:

Mode	Available fan speeds
AI Auto/Auto/Dry	(Auto)
Cool/Heat	(Auto), (Low), (Med), (High), (Turbo)
Fan	(Low), (Med), (High), (Turbo)

To adjust the airflow direction

Keep the airflow in a constant direction by stopping the movements of the vertical and horizontal airflow blades.

In operation ► or

NOTE

- If you adjust the vertical airflow blade manually, it may not close completely when you turn off the air conditioner.
- Always use the remote control to adjust the airflow blades. Do not move the blades by hand. They may not operate normally.
- You cannot control the vertical airflow direction in Cool mode when the good'sleep function is on.

At a Glance

Remote Control Operation

At a Glance

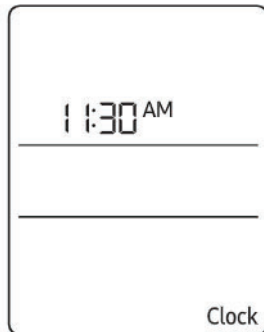

Setting the Current time

Before using the functions of the air-conditioner, set the current time.



NOTE

- You can set the time in hourly units from 1 hour to 12 hours according to AM, PM and in minute units from 0 to 59 minutes.
- Current time setting will be cancelled if you don't press the SET (C-F 3sec) button within 10 seconds after setting the time. Therefore, check for the current time on the remote controller display.

Power Smart Features

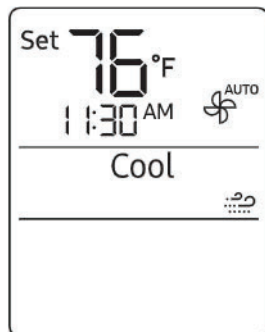

WindFree Cooling function

Use the WindFree Cooling function to enjoy a mild breeze coming through fine holes in the WindFree panel instead of air coming directly through the airflow blades.

In Cool/Dry/Fan mode ▶

NOTE

- To cancel this function, press the (WindFree) button again.
- When the WindFree Cooling function is on, the air conditioner automatically controls the temperature and fan speed to keep your room mild and comfortable.
- When the WindFree Cooling function is canceled, the air conditioner returns to the original fan speed and air comes out of the airflow blades.
- In Cool mode, the recommended set temperature during the WindFree Cooling operation is 76 °F to 79 °F (24 °C to 26 °C).
- You can use the WindFree Cooling function in Cool, Dry, or Fan mode.
- You cannot select the Quiet function during the WindFree Cooling operation.
- Selecting the WindFree Cooling function cancels the Fast, Eco, and airflow direction (,) functions.

Power Smart Features

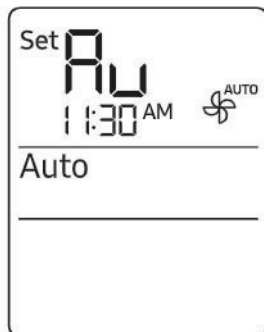



Smart Features

AI Auto mode

Use AI Auto mode to automatically operate any of Cool, Dry, Heat, and WindFree Cooling modes depending on the learned user patterns gathered from an external server via Wi-Fi module. The favourite temperature and operation mode are also set based on the current temperatures (indoor/outdoor) and the gathered user patterns.



NOTE

- You can use this mode after Wi-Fi is connected. Otherwise, Auto mode is activated.
- In AI Auto mode, the  (AI Auto) and  (Wi-Fi) indicators appear on the display of the indoor unit.
- If the gathered user patterns are not sufficient, the set temperature is set to 76 °F(24 °C).
- The set temperature is controlled within the range of 72 °F to 79 °F(22 °C to 26 °C) in AI Auto mode. You can also change it manually.
- When you press  (Mode) in AI Auto mode, the mode is cancelled.
- If you change the set temperature in AI Auto mode, it automatically changes back to the AI comfort temperature after 1 hour.

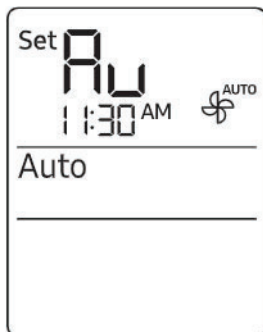

Auto mode

Use Auto mode to perform the powerful cooling or heating function to automatically reach the desired temperature. When the difference between the room temperature and the set temperature decreases, the air conditioner controls the fan speed and airflow direction.

► ► Select Auto.

NOTE

- If Wi-Fi cannot be connected or the Wi-Fi function is not supported, this Auto mode is automatically activated instead of AI Auto mode.
- When the room temperature is higher than the set temperature, the air conditioner automatically produces cool air.
- When the room temperature is lower than the set temperature, the air conditioner automatically produces warm air.

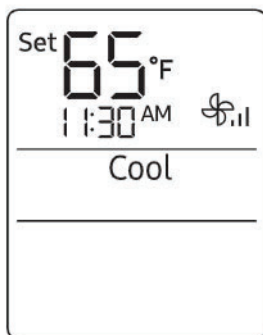

Cool mode

Use Cool mode to stay cool in hot weather.

► ► Select Cool.

NOTE

- For comfort, keep the temperature difference between the indoor and outdoor air within 9 °F (5 °C).
- After selecting Cool mode, select the desired function, temperature, and fan speed.
 - To cool more quickly, select a lower temperature and a faster fan speed.
 - To save energy, select a higher temperature and a slower fan speed.
 - As the room temperature nears the set temperature, the compressor motor will slow down to save energy.

Smart Features

Power Smart Features

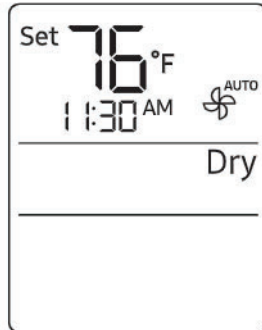

Dry mode

Use Dry mode in rainy or humid weather.



NOTE

- The proper set temperature range for dehumidifying operation is 76 °F to 79 °F (24 °C to 26 °C). If you feel that the current humidity seems high, use a lower set temperature.
- You cannot use Dry mode for heating. Dry mode is designed to produce a cooling side-effect.

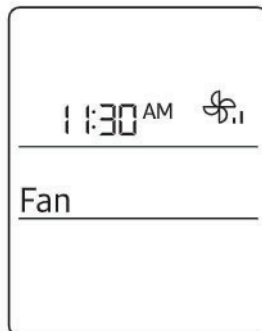

Fan mode

Use Fan mode to run the air conditioner like a floor fan, providing a breeze without heating or cooling.



NOTE

- If the air conditioner will not be used for an extended period of time, run it in Fan mode for 3 to 4 hours to dry the internal components.
- The outdoor unit does not operate in Fan mode. This is normal and not a fault with the air conditioner.

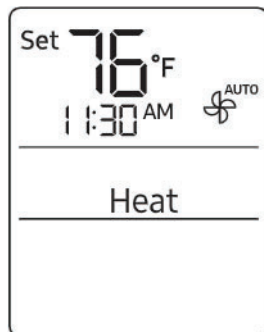

Heat mode

Use Heat mode to stay warm.



NOTE

- While the air conditioner warms up, the fan may not operate for about 3 to 5 minutes at the beginning to prevent cold blasts.
- If the air conditioner heats insufficiently, use an additional heating appliance in combination with the air conditioner.

Automatic defrost

When the outdoor temperature is low and the humidity is high, frost may develop on the outdoor heat exchanger, which may decrease heating efficiency. When these conditions are met while Heat mode is on, the air conditioner runs the Defrost function for 5 to 12 minutes to remove frost from the outdoor heat exchanger.

NOTE

- When the Defrost function is on, the **df** (Defrost) indicator appears on the indoor unit display, steam is produced on the outdoor unit, the air conditioner moves the airflow blades to the lowest position to prevent cold air from coming out from the indoor unit.
- You cannot select other functions with the remote control until the Defrost function is finished.

Variety Smart Features

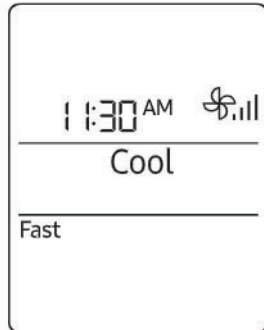

Fast function

Use the Fast function to quickly cool or heat your room. This function is the most powerful cooling and heating function provided by the air conditioner. You can select this function in Cool or Heat mode.

In Cool or Heat mode ▶ 

NOTE

- You can change the airflow direction, but you cannot change the set temperature and the fan speed.
- When you select the Fast function in Heat mode, you may not be able to increase the fan speed for 3 to 5 minutes while the unit heats up.
- Selecting the Fast function cancels the WindFree Cooling, Eco, good'sleep, and Quiet functions.
- You can also start the Fast function from the Options menu:

In Cool or Heat mode ▶  ▶   ▶

Select Fast. ▶ 

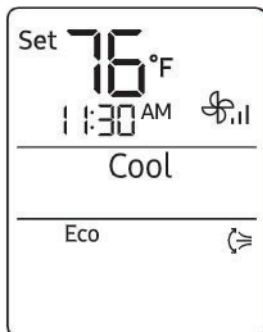

Eco function

For the multi system, this function is not supported.

Use the Eco function to reduce electricity consumption while staying cool or warm. You can select this function in Cool or Heat mode.



In Cool or Heat mode ▶  ▶   ▶

Select Eco. ▶ 

NOTE

- When the Eco function starts, the pattern  appears on the remote control for a few seconds and vertical air swing begins.
- You can change the set temperature, airflow direction, and fan speed.
- The allowed set temperatures while the Eco function is on are:

Mode	Minumum set temperature	Maximum set temperature
Cool	76 °F (24 °C)	86 °F (30 °C)
Heat	47 °F (8 °C)	86 °F (30 °C)

- If you change the set temperature to be outside the allowed range for the current mode, the set temperature is automatically reset to be within the range.
- When you turn off the Eco function, the air swing continues. Use the  (Vertical air swing) or  (Horizontal air swing) button to turn it off.
- Selecting the Eco function cancels the Wind-Free Cooling, good'sleep, Fast, and Quiet functions.

Smart Features

Variety Smart Features

Smart Features

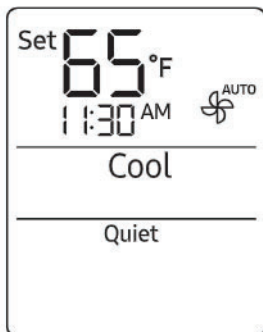

Quiet function

Use the Quiet function to reduce the unit's operating noise. You can select this function in Cool or Heat mode.

In Cool or Heat mode ▶ ▶ ▶

Select Quiet. ▶

NOTE

- You can change the set temperature and the airflow direction, but you cannot change the fan speed.
- Selecting the Quiet function cancels the WindFree Cooling, Eco, good'sleep, and Fast functions.

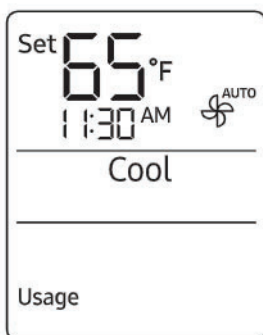

Electricity consumption check

For the multi system, this function is not supported.

Use the Usage function to check the amount of electricity consumed by using the air conditioner. The amount consumed is displayed on the indoor unit display for a few seconds, and the set temperature appears.

In operation ▶ ▶ ▶

Select Usage. ▶

The value range displayed is between 0.1 kWh and 99 kWh. Electricity consumption is calculated from the moment the air conditioner turns on. The value is reset when the air conditioner turns off.

NOTE

- The usage shown on the indoor unit display may slightly differ from the amount of electricity actually consumed.
- You can view electricity consumption only when the air conditioner is operating.



Usage time check

For the single system, this function is not supported.

Use the Usage time function to check the operation duration from the moment when the air conditioner is turned on to the moment when the Usage time function is selected. The usage time is displayed on the indoor unit display for a few seconds, and the set indoor temperature appears.

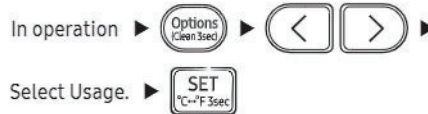

The usage time is displayed in units of hour. For example, 0.1 is equivalent to 6 minutes; 2.5, 2 hours and 30 minutes; 3.7, 3 hours and 42 minutes. The value range displayed is between 0.0 and 99. The value is reset when the air conditioner turns off.

NOTE

- The usage time shown on the indoor unit display may a little differ from the actual operation time of the air conditioner.
- You can view the usage time only when the air conditioner is operating.

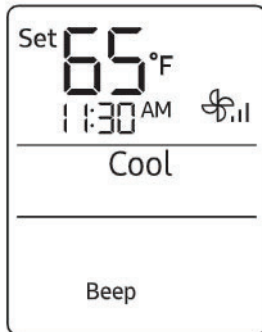

Beep function

Use the Beep function to turn on or off the beep that sounds when you press a button on the remote control.



Smart Features

Variety Smart Features

Auto clean function

Use the Auto clean function if the indoor unit produces odors.

Activating Auto clean

To activate Auto clean, press the  (Options) button for at least 3 seconds.

The indoor unit display shows:



If the air conditioner is off, Auto clean starts immediately. If the air conditioner is running, Auto clean starts as soon as the air conditioner turns off.

NOTE

- You can also activate Auto clean from the Options menu:



- Once Auto clean is selected, it is always activated whenever the air conditioner turns off.
- Auto clean runs for 10 to up to 30 minutes depending on internal dry conditions. The indoor unit display shows the cleaning progress from 1% to 99%.
- If you start another function while Auto clean is progressing, Auto clean pauses and will resume when the other function stops.
- When Auto clean completes, the air conditioner turns off.
- Auto clean does not run after Heat or Fan mode.

Canceling Auto clean

To cancel Auto clean while it is running, follow the procedure below:

 ▶ Press and hold for 3 or more seconds.

or

 ▶   ▶ Select Clean. ▶ 

NOTE

- Canceling Auto clean does not deactivate it.

Deactivating Auto clean

To deactivate Auto clean, follow the procedure below while the air conditioner is in operation or turned off:

 ▶   ▶ Select Clean. ▶ 

Variety Smart Features

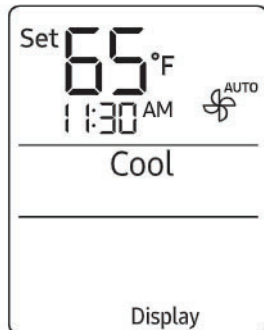

Display lighting function

Use the Display lighting function to turn on or off the lighting of the indoor unit display.



NOTE

- If you change the current mode or function when the Display lighting function is on, the display lighting turns on for 5 seconds and then turns off again.
- To turn off the Display lighting function, run the method above again or turn the product off and on.

Wi-Fi function (SmartThings app)

Turn on the Wi-Fi function to pair your smartphone with the air conditioner.

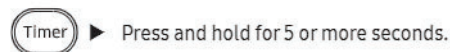

NOTE

- When you turn on the Wi-Fi function, your smartphone pairs with the air conditioner, the  (Transmit) indicator blinks, and **AP** appears on the remote control display for a few seconds.
- Once your smartphone is connected with the air conditioner, you can control it via the wireless Internet using the SmartThings app installed on your smartphone.
- For more information about how to prepare your smartphone for connection and how to control the air conditioner using the SmartThings app, see "SmartThings app" on page 47.
- To turn on or off the Wi-Fi, press and hold  (Mode) and  for 5 seconds.
 - In order to launch the SmartThings app, press and hold the  (Timer) button for 5 seconds, which enables to connect the air conditioner.

Time scheduling

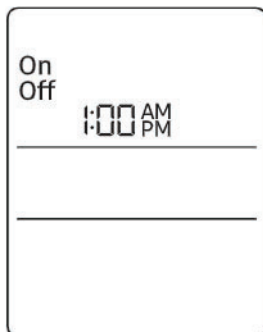

Timed on/ Timed off function

Use the Timed on/off function to turn the air conditioner on or off after a duration. Scheduling durations before the air conditioner turns on or off helps use the air conditioner economically.

- Check the current time on the remote controller before using this function.
- The default time is 1 AM on the remote controller. The current time is reset to default time after changing the batteries.

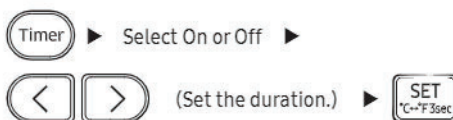

NOTE

- You can set the time in hourly units from 1 hour to 12 hours according to AM, PM and in minute units from 0 to 59 minutes. Set the time interval to - : - : to cancel the Timed on/off function.
- When you start the Timed on/off function, the ⌚ (Timer) indicator appears on the indoor unit display.
- After starting the Timed on function, you can change the mode and the set temperature. You cannot change the set temperature while the Fan mode is running.
- You cannot set the same duration for both Timed on and Timed off functions.

Combining Timed on and Timed off	
When the air conditioner is off	Example: Timed on 3 hours, Timed off 5 hours The air conditioner turns on 3 hours after the last time you press the (SET) button to start the Timed on/off function, remains on for 2 hours, then turns off again.
When the air conditioner is on	Example: Timed on 3 hours, Timed off 1 hour The air conditioner turns off 1 hour after the last time you press the (SET) button to start the Timed on/off function, remains off for 2 hours, then turns on again.

Smart Features

Time scheduling

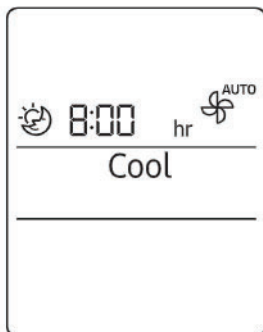



Smart Features

good'sleep function

Use the good'sleep function to save energy while you are sleeping. You can select this function in Cool or Heat mode.

In Cool or Heat mode ▶ **Timer** (Select ) ▶

  (Set the duration.) ▶ **SET** 

NOTE

- You can adjust the set temperature by 1 °F between 61 °F(16 °C) and 86 °F(30 °C) (Cool) / 47 °F(8 °C) and 86 °F(30 °C) (Heat).
- When you start the good'sleep function, the  (Timer) indicator appears on the indoor unit display.
- You can set the time in half hour unit from 30 minutes to 3 hours and hour unit from 3 to 12 hours. Set the operation time to - : - to cancel the good'sleep function.
- The recommended set temperatures while the good'sleep function is on are:

Mode	Recommended set temperature	Optimal set temperature
Cool	77 °F to 81 °F (25 °C to 27 °C)	79 °F (26 °C)
Heat	70 °F to 73 °F (21 °C to 23 °C)	72 °F (22 °C)

- The default operation time for the good'sleep function is 8 hours. If the operation time is set to over 5 hours, the Wake up function begins 1 hour before the set time. The air conditioner stops automatically when the operation time expires in the Cool mode, the air conditioner will run the function that you have started most recently in the Heat mode.
- When the Timed on, Timed off, and good'sleep functions are overlapped, the air conditioner operates its timer with only the function that you have started most recently.
- The good'sleep function can operate while the WindFree Cooling function is on.
- Selecting the good'sleep function cancels Eco, Fast, and Quiet functions.

Schedule

Task	How often	By whom	Instruction
Run the Auto clean function.	As needed	Owner	"Auto clean function" on page 26.
Clean the filter.	Once every two weeks	Owner	"Cleaning the filter" on page 33.
Clean the WindFree panel	At least once a month	Owner	"Cleaning the WindFree panel" on page 34.
Clean the exterior of the indoor unit.	As needed	Owner	"Cleaning the outside of the indoor unit" on page 32.
Clean the exterior of the outdoor unit.	At least once a year	Owner	"Cleaning the heat exchanger on the outdoor unit" on page 32.
Replace the remote control batteries	As needed	Owner	"Replacing the remote control batteries" on page 13.
Apply corrosion inhibitor on outdoor unit. (Only if installed near salt water such as an ocean)	At least once a year	Qualified technician	Contact your service provider.
Clean inside the indoor or outdoor unit.	Once a year	Qualified technician	Contact your service provider.
Inspect the units, electrical connections, refrigerant tubes, and protections.	Once a year	Qualified technician	Contact your service provider.

Cleaning

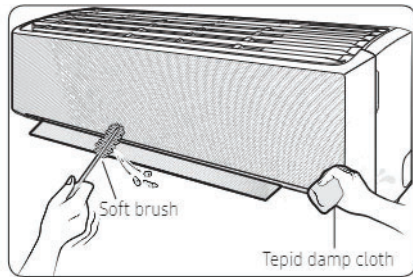

Cleaning the outside of the indoor unit

- 1 Turn off the air conditioner and wait until the fan stops.
- 2 Disconnect the power supply.
- 3 Use a soft brush or tepid damp cloth to clean the exterior.

⚠ WARNING

- Do not clean the appliance by spraying water directly onto it. Water entering the unit may result in electric shock or fire that could cause death, serious injury, or property damage:

⚠ CAUTION

- Do not use an alkaline detergent to clean the indoor unit display.
- Do not use sulphuric acid, hydrochloric acid, or organic solvents such as paint thinner, kerosene, acetone, benzene, or alcohol to clean the unit surfaces.

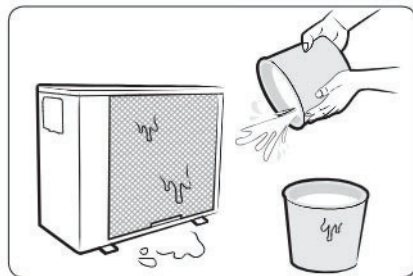

Cleaning the heat exchanger on the outdoor unit

- 1 Turn off the air conditioner and wait until the fan stops.
- 2 Disconnect the power supply.
- 3 Spray water on the heat exchanger to remove dust and other debris.

⚠ CAUTION

- Do not use sulphuric acid, hydrochloric acid, or organic solvents such as paint thinner, kerosene, acetone, benzene, or alcohol to clean the unit surfaces.
- If you need to inspect or clean the inside of the heat exchanger on the outdoor unit, contact a local service centre for help.

Cleaning the filter

Clean the air filter every two weeks or when the **CF** (filter-cleaning reminder) appears on the indoor unit display. The time between cleanings may vary, depending on the usage and environmental conditions.

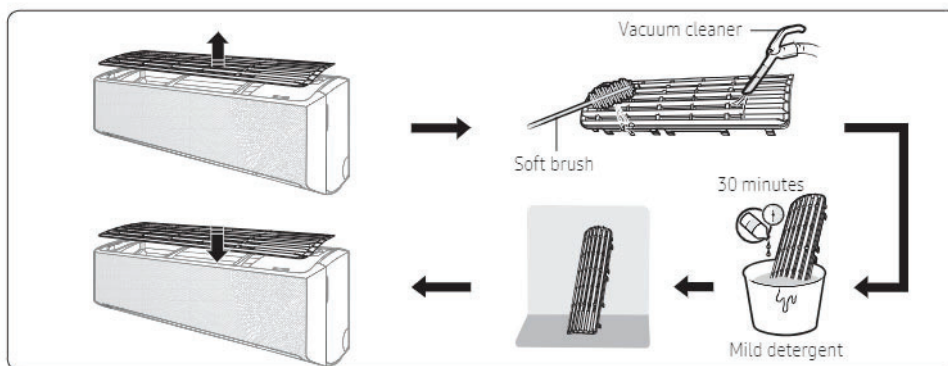

- 1 Slide the filter off of the unit.
- 2 Use a soft brush or vacuum cleaner to remove any dust or debris on the filter.
- 3 Soak the filter in a solution of water and mild detergent for 30 minutes.
- 4 Rinse the filter and let it air dry in a well-ventilated area that is out of direct sunlight.
- 5 Reinstall the filter.
- 6 Reset the filter-cleaning reminder:



⚠ CAUTION

- Take care not to damage the filter during cleaning.
- Do not scrub the air filter with a hard-bristle brush or another cleaning utensil.
- Do not expose the air filter to direct sunlight when drying it.

Cleaning

Cleaning the WindFree panel

Clean the WindFree panel at least once a month.

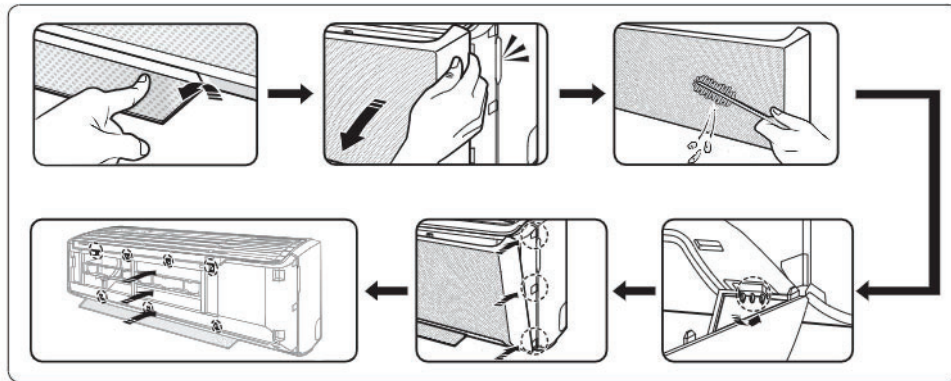

- 1 Pull the airflow blade open.
- 2 Hold and pull both sides of the WindFree panel until it comes free from the air conditioner.
- 3 Use a soft brush or vacuum cleaner to remove any dust.
- 4 Hang the WindFree panel in the grooves at the bottom left and right.
- 5 Align the projections of the WindFree panel with the grooves at the top, middle, and bottom of the front panel.
- 6 After inserting the WindFree panel, press the top 4 places and the bottom 3 places by hand so that there is no gap to the panel.

CAUTION



- If you attach the WindFree panel without the airflow blade being open, it may become obstructed by the WindFree panel and may not open properly.

Troubleshooting

If the air conditioner is not operating normally, refer to the troubleshooting guide below.

Problem	Solution
The air conditioner stops working.	<ul style="list-style-type: none"> • Make sure the unit is receiving power. • Check the circuit breaker. If it is flipped off, flip it on again and restart the unit. If the problem persists, contact your service provider. • The Timed off function may have turned off the unit. Turn on the unit again.
Cannot change the temperature.	<ul style="list-style-type: none"> • Check if the unit is in Fan or Fast mode. If so, you cannot change the set temperature; the unit automatically controls the set temperature.
Improper airflow temperature.	<ul style="list-style-type: none"> • Check the set temperature. In Cool mode, cooling occurs only when the set temperature is lower than the current temperature. In Heat mode, heating occurs only when the set temperature is higher than the current temperature. • Use the  (Temperature) button on the remote control to change the set temperature. • Check if the air filter is blocked with dirt or debris. If the air filter is blocked, the cooling and heating performance may decrease. Clean the air filter regularly (page 33). • Check if the outdoor unit is covered or is installed near obstacles. Remove the coverings and obstacles. • Check if the Defrost function is on (page 21). During defrost, the fan stops and warm air does not come out. • Check if doors or windows are open. This may cause poor circulation or performance. Close all doors and windows. • Check if the pipe length between the units exceeds the maximum pipe length (see "Typical installation" in the Installation manual). If so, the cooling and heating performance may decrease.
Cannot change the airflow direction.	<ul style="list-style-type: none"> • Check if the good'sleep function is on in Cool mode. If so, you cannot control the airflow direction.
Cannot change the fan speed.	<ul style="list-style-type: none"> • Check if the unit is in Auto, Dry, or Fast mode or the good'sleep function is on in Cool mode. In these conditions, you cannot control the fan speed; the unit automatically controls the fan speed.

Troubleshooting

Problem	Solution
The remote control does not work.	<ul style="list-style-type: none"> • Replace the batteries in the remote control. • Make sure the remote control can send an unobstructed signal to the unit. • Keep bright lights away from the unit. Light from fluorescent bulbs or neon signs may interrupt the signal from the remote control.
The Timed on/off function does not work.	<ul style="list-style-type: none"> • Make sure to press the  (SET) button on the remote control when setting the timer.
The indicator on the remote control blinks continuously.	<ul style="list-style-type: none"> • Press the  (Power) button to turn off the unit, or disconnect the power plug. • If the indicator light on the remote control continues blinking, contact your service provider.
Odors are coming from the unit during regular operation.	<ul style="list-style-type: none"> • If the unit is operating in a smoky area, ventilate the room or operate the unit in Fan mode for 3 to 4 hours. There are no components in the unit that produce a strong odor. • Check if the drain lines are clean. Clean them regularly.
The remote control display shows an error message.	<ul style="list-style-type: none"> • If the indoor unit indicator blinks, write down the error code. Contact your service provider and provide them with the error code.
The unit is generating noise.	<ul style="list-style-type: none"> • It is normal for the unit to generate some noise while operating. If the pipe length between the units is less than 3 m and no coil was used (see "Typical installation" in the Installation manual), additional noise may be transmitted from the outdoor unit to the indoor unit via the piping.
Smoke is coming from the outdoor unit.	<ul style="list-style-type: none"> • In winter, most likely this is steam coming from the outdoor heat exchanger while the Defrost function is on.
Water drips from the pipe connections on the outdoor unit.	<ul style="list-style-type: none"> • Condensation may develop when the ambient temperature or humidity changes significantly. This is normal.

SmartThings app

The SmartThings app may change without prior notice to improve product usability and performance. Use the SmartThings app on your smartphone to control the air conditioner via the wireless Internet. To remotely control the air conditioner, you need to connect your smartphone to the air conditioner. If already connected, skip to "Step 6. Controlling the air conditioner with your smartphone" on page 38.

Step 1. Checking the requirements for connection

Before connecting your smartphone with the air conditioner, make sure that the following requirements are met:

- Wi-Fi access point: 2.4 GHz Wi-Fi access point only
- The air conditioner and your smartphone must be within the coverage of the same Wi-Fi access point and connected to it. After the connection, you can control the air conditioner from any place via various wireless networks such as Wi-Fi, 3G, LTE and 5G.
- Recommended Android phones: Android 6.0 or later, at least 2 GB RAM
- Supported Apple phones: iOS 10.0 or later, iPhone 6 or later
- Android tablets and iPads are not supported.

Step 2. Connecting your smartphone to the Wi-Fi network

- 1 Turn on the Wi-Fi access point.
- 2 Tap **Settings** → **Wi-Fi** on your smartphone.
- 3 Tap the **Wi-Fi** switch to activate it, and then select the 2.4 GHz Wi-Fi access point to connect to.
- 4 If needed, enter the password for the access point.
- 5 Tap **Advanced**.
- 6 Tap the **Switch to mobile data** switch to deactivate it.

Step 3. Installing the SmartThings app

If the SmartThings app is not installed on your smartphone, follow the procedure below. If installed, skip to "Step 4. Configuring the SmartThings app" on page 37.

- 1 Launch **Play Store** or **App Store**.
- 2 Tap the search field, and then search for "SmartThings".
- 3 Tap **INSTALL** for the found SmartThings app item.
- 4 Select **Agree**.

Step 4. Configuring the SmartThings app



After the SmartThings app is installed, follow the procedure below to configure it. If already configured, skip to "Step 5. Connecting your smartphone to the air conditioner" on page 38.

- 1 Launch the **SmartThings** app.
- 2 When you see pop-up windows asking for location, Wi-Fi, Bluetooth permissions, tap **Start**.
- 3 Tap **Log In**.
- 4 If you have no Samsung account, tap **Add account** to create your Samsung account.
- 5 Log in to your Samsung account.
- 6 Consent to **TERMS AND CONDITIONS**.
- 7 When you see a pop-up window asking for access permission to location information, tap **ALLOW**.

SmartThings app

Step 5. Connecting your smartphone to the air conditioner

- 1 Plug in the power cord of the air conditioner, and then turn on the power.
- 2 Launch the SmartThings app.
- 3 Tap **Add device** on the home screen of the SmartThings app.
- 4 Tap **ADD DEVICE MANUALLY**.
- 5 Tap **Air conditioner > Room air conditioner**.
- 6 Press the  (Timer) button on the remote control for at least 4 seconds.

To notify that registration of the selected air conditioner to your Samsung account is in progress, the  (Transmit) indicator blinks for several seconds and **RP** appears on the remote control display. When the connection is finished, the  (Transmit) indicator turns off and **RP** disappears. A new device card for the selected air conditioner is added to the home screen of the SmartThings app.

Step 6. Controlling the air conditioner with your smartphone

- 1 Launch the SmartThings app.
- 2 On the home screen of the SmartThings app, tap the device card for the air conditioner, which was added when you proceeded with "Step 5. Connecting your smartphone to the air conditioner" on page 38.
- 3 Refer to the table on the next page and remotely control the air conditioner with your smartphone.

WARNING

- RF exposure warning statement – for keeping 20cm distance when installing this module.
- Warning that this module should not be installed and operating simultaneously with other radio without additional evaluation or FCC filing.

- Your device uses non-harmonised frequency and is intended for use in all European countries. The WLAN can be operated in the EU without restriction indoors, but cannot be operated outdoors in France.

Specifications

Wi-Fi	
Frequency Range	Transmitter Power(Max)
2412 - 2472 MHz	20 dBm

Open Source Announcement

The software included in this product contains open source software. You may obtain the complete corresponding source code for a period of three years after the last shipment of this product by sending an email to <mailto:oss.request@samsung.com>.

It is also possible to obtain the complete corresponding source code in a physical medium such as a CD-ROM; a minimal charge will be required.

The following URL http://opensource.samsung.com/opensource/SMART_AT_051/seq/0 leads to the download page of the source code made available and open source license information as related to this product. This offer is valid to anyone in receipt of this information.



Category	Function	Description
Monitoring	Set temperature	Displays the set temperature.
	Current temperature	Displays the current temperature.
Control	Power	Turns the air conditioner on or off.
	Mode	Selects the desired operation.
	Temperature	Adjusts the indoor set temperature.
	Fan Speed	Sets the fan speed of operation mode.
	Wind direction	Sets the fan directions of operation mode.
	WindFree Cooling	Turns the WindFree Cooling function on or off.
	Schedule	<p>Sets the Timed on/off function.</p> <ul style="list-style-type: none"> The maximum number of schedules you can set using the Timed on/off function is 10. The set times for the Timed on and Timed off functions must be different. Once the Timed on/off function is set, the setting remains even if you unplug the air conditioner and plug in it again.
	Options	<p>Selects an option function of operation mode.</p> <ul style="list-style-type: none"> The available options might be different depending on the air conditioner model. The fan speed and airflow direction are set automatically according to the selected options. For detailed information on the options of the product, see page 17 ~ 24.
	Settings	<p>Sets additional functions.</p> <ul style="list-style-type: none"> Press the Settings button on the control screen to check or set detailed information of air conditioner. The functions of Clean, Filter, and Beep can be set. <ul style="list-style-type: none"> When the Beep function is off, the beep sound from the device will be mute.

SAMSUNG



TO: Hight Jackson Associates
jandrade@hjarch.com

ATTN: Jorge Andrade

RE: Farm Credit - Russellville, AR
HVAC

DATE: 06/26/2023 JOB NO. 22-166

ELECTRONIC SUBMITTAL WAS REVIEWED AS FOLLOWS:

- | | | |
|--|---|---|
| <input checked="" type="checkbox"/> CUT SHEETS | <input type="checkbox"/> NO EXCEPTIONS TAKEN | <input checked="" type="checkbox"/> APPROVED |
| <input type="checkbox"/> DRAWINGS | <input checked="" type="checkbox"/> NOTE MARKINGS | <input type="checkbox"/> REJECTED |
| <input type="checkbox"/> OTHER | <input type="checkbox"/> COMMENTS ATTACHED | <input type="checkbox"/> RESUBMIT |
| | | <input type="checkbox"/> RESUBMIT only items marked |

REMARKS:

Submittal - 23 81 27 Small Split-System Heating & Cooling Submittal

ENGINEER'S REVIEW IS FOR GENERAL CONFORMANCE WITH THE DESIGN CONCEPT AND CONTRACT DOCUMENT. MARKINGS OR COMMENTS SHALL NOT BE CONSTRUED AS RELIEVING THE CONTRACTOR FROM COMPLIANCE WITH THE PROJECT PLANS AND SPECIFICATIONS, NOR DEPARTURE THEREFROM. THE CONTRACTOR REMAINS RESPONSIBLE FOR DETAILS AND ACCURACY, FOR CONFIRMING AND CORRELATING ALL QUANTITIES AND DIMENSIONS, FOR SELECTING FABRICATION PROCESSES, FOR TECHNIQUES OF ASSEMBLY AND PERFORMING HIS WORK IN A SAFE MANNER.

Copies To:

- File
- Owner
- Architect
- Other

BY: Nathan Wilson, PE

HSA Engineering Consulting Services, Inc.

7405 Ellis Street
Fort Smith, AR 72916

479.452.8922
www.hsaconsultants.com

SUBMITTAL



Project Name: Farm Credit, Russellville, AR
Project Number: 02-23-2720
Transmitted To: Hight Jackson Associates
Specification: 23 81 27 -01 Small Split Systej Package Product Data

Construction Manager:

NABHOLZ CONSTRUCTION SERVICES	
<input type="checkbox"/>	Revise & Resubmit
<input type="checkbox"/>	Reviewed & Amend As Noted
<input checked="" type="checkbox"/>	Reviewed
By: <u>Ann Miller</u> Date: <u>06.05.2023</u>	

Design Review Comments:

- | | |
|--|---|
| <input type="checkbox"/> APPROVED | <input type="checkbox"/> REVISE AND RESUBMIT |
| <input type="checkbox"/> APPROVED AS CORRECTED | <input type="checkbox"/> NOT APPROVED |
| <input checked="" type="checkbox"/> REVIEWED BY CONSULTANT | <input type="checkbox"/> SUPPLEMENTAL HJ COMMENTS |

Checking is only for conformance with the design concept of the Project and compliance with the information given in the Contract Documents. Contractor is responsible for dimensions to be confirmed and correlated at the job site, for information that pertains solely to the fabrication process or to the techniques of construction; and for coordination of the work of all trades.

BY: Emerson Cochran
DATE: 06.26.23



SUBMITTAL

PRODUCT	AC-1
SPECIFICATION	238127
MANUFACTURER	Samsung
JOB NAME	Farm Credit
LOCATION	Russellville, AR.
ENGINEER	HSA
CONTRACTOR	CSUSA
CONTRACTOR POC	Jon Davis
DATE	5/3/2023
SUBMITTED BY	Eric Blaylock

5440 Northshore Drive – North Little Rock, Arkansas 72118 – Tel: 501.374.5420 Fax: 501.370.9298

Job Name Farm Credit
 Purchaser Eric Blaylock
 Submitted to CSUSA
 Unit Designation _____

Location Russellville, AR.
 Engineer HSA
 Reference Approval Construction
 Schedule # AC-1

Specifications

Model	US Code	Indoor Unit	RNS12CMB
		Outdoor Unit	RXS12CMB
Model Number		Indoor Unit	AR12BSFCMWKNCV
		Outdoor Unit	AR12BSFCMWKXCV
Performance	Nominal Capacity ¹	Cooling / Heating (Btu/h)	12,000 / 12,000
	Capacity Range	Cooling (Btu/h)	3,000 - 14,500
		Heating (Btu/h)	2,600 - 20,000
	SEER / EER		21.5 / 12.05
	COP	Nominal Heating	3.66
Power	HSPF		12.0
	AHRI Reference Number		207349354
	Voltage	∅ / V / Hz	1 / 208-230 / 60
	Working Voltage Range (VAC)		176 - 254
Operating Temperatures	Operating Current (Min./Std./Max.)	Cooling (A)	1.2 / 4.8 / 6.2
		Heating (A)	1.1 / 4.6 / 9.3
	Max. Breaker	Amps	20
Dimensions	Min. Circuit Ampacity (A)		12.5
	W X H X D (in.)	Indoor Unit	32 5/16 X 11 3/4 X 8 7/16
		Outdoor Unit	31 1/8 X 21 9/16 X 11 1/4
	Weight (lbs.)	Indoor Unit	20.1
Sound Pressure Level		Outdoor Unit	69.9
	Condensate Connection		1 1/16" OD
Operating Temperatures	Indoor Unit	Low / High (dB)	20 / 38
	Outdoor Unit	High (dB)	46
Pipe Connections	Outdoor	Cooling	14° ~ 115°F (-10° ~ 46.1°C)
		Heating	-5° ~ 75°F (-20.5° ~ 23.9°C)
	Indoor	Cooling	61° ~ 90°F (16° ~ 32°C)
		Heating	81°F (27°C) or less
Refrigerant	Indoor & Outdoor	High side (flare)	1/4"
		Low side (flare)	3/8"
	Maximum / Minimum Line Set Length (ft.)		66 / 9.8
Compressor	Maximum Vertical Separation (ft.)		49
	Type		R410A
	Control Method		Electronic Expansion Valve
	Factory Charge	oz.	35.3
	Charged for Additional Refrigerant		25 feet 0.16 oz. / ft. over 25 ft.
Evaporator Fan	Manufacturer		Samsung
	Type		BLDC Rotary
Condenser Fan	RLA	A	9.2
	Type		BLDC motor with cross-flow fan
	Air Volume (L/M/H/Turbo)	Cooling (CFM)	300 / 335 / 371 / 385
		Heating (CFM)	335 / 371 / 403 / 420
Safety	Consumption	Watts	27 X 1
	FLA	Amps	0.12
	Motor Output	Watts	40
Safety	FLA	Amps	0.18
	Air Volume	CFM (max.)	1,589
Safety	Certifications		ETL (UL 1995)
	Devices		PCB fuses, indoor unit terminal block thermal fuse, current transformer, over-voltage protection, crankcase heating, temperature limit protection logic, compressor overload sensing

coordinate change in electrical requirements with electrical contractor. any cost associated with changes shall be mechanical contractor or equipment suppliers responsibility.

(actual equipment appearance may vary)

General Information

- The indoor unit shall feature WindFree™ mode. In cooling mode, as room temperature nears set temperature, the unit will close its louver and will disperse air into the space through thousands of micro-holes on the front of the indoor unit preventing cold air drafts on occupants.
- The indoor unit shall have Wi-Fi capability as standard
- Outdoor unit shall provide 208/230V power to indoor unit via 14 AWG X 3 interconnect power cable

Construction

- Indoor unit chassis shall be UL94 V0 with a galvanized steel mounting bracket
- The indoor unit shall have easy-access to wire, pipe, and drain connections via access panel on the bottom of the unit for simple installation and service
- The outdoor unit shall be galvanized steel with a baked on powder coated finish for durability

Heat Exchanger

- The heat exchangers shall be mechanically bonded fin to copper tube

Refrigerant System

- The compressor shall be hermetically sealed, inverter controlled, BLDC Rotary
- Refrigerant flow shall be controlled by an electronic expansion valve at the outdoor unit

Indoor Fan

- The indoor fan shall be a single, antibacterial cross-flow type
- Three fan speed settings and auto setting
- Automatic (motorized) vertical swing (up/down) and horizontal swing (left/right) louvers

Controls

- The system shall have a built in Wi-Fi adapter as standard to allow control and monitoring using the Samsung SmartThings app (Android, iOS)
- Dual set temperature support when connected to MWR-WG00UN Advanced Wired Controller and supported central control options.
- The indoor unit shall have a simple connection for overflow detection devices or any other normally closed contact for simple unit shutdown
- The indoor unit shall ship with a wireless controller, holder, and batteries
- Wired controller options available
- Samsung central control compatible (MIM-R10UN accessory required)
- Interconnect control wire between outdoor and indoor unit shall be 16AWG X 2

Convenience

- System energy consumption can be viewed using the Samsung SmartThings mobile app or on the indoor unit display using the included wireless controller
- AI (artificial intelligence) Auto Mode technology monitors factors such as indoor temperature, outdoor temperature, set temperature, and operating time to learn the patterns within your home to automatically adjust system operation to maximize occupant comfort and efficiency (Wi-Fi connection required)
- Eco Mode to reduce energy consumption during low demand operation
- Smart install mode - startup system diagnostics operation to ensure system readiness during initial operation
- Auto restart
- Auto Clean Function
- 7-segment digital display on front of unit to display temperature and unit status
- "Fast" mode to quickly reach set temperature
- Auto changeover
- Good sleep mode
- Quiet mode
- Dry mode
- Simple ON/OFF time function - Using the wireless controller specify the ON and/or OFF times
- Electro-static, washable, main filter as standard accessible from the top of unit

¹ Certified in accordance with the AHRI Unitary Small Air-Source Heat Pumps (USHP) Certification Program which is based on the latest edition of AHRI Standard 210/240.

*The WindFree™ unit delivers an air current that is under 0.15 m/s while in WindFree™ mode. Air velocity that is below 0.15 m/s is considered "still air" as defined by ASHRAE (American Society of Heating, Refrigerating, and Air-Conditioning Engineers).

Samsung HVAC maintains a policy of ongoing development, specifications are subject to change without notice. Refer to www.AHRIdirectory.org for current reference numbers.

Optional Accessories

Condensate pump	Aspen Mini Orange	<input type="checkbox"/>	ASP-MO-UNIV 110-250
	Blue Diamond	<input type="checkbox"/>	BD-BLUE-230
Wired controller ¹	Advanced	<input type="checkbox"/>	MWR-WG00UN
	Simple Touch	<input type="checkbox"/>	MWR-SH11UN
Wired controller sub-PCB		<input type="checkbox"/>	MIM-A00UN
24 VAC thermostat adapter ¹		<input type="checkbox"/>	MIM-A60UN
External temperature sensor		<input type="checkbox"/>	MRW-TA
Central control interface module		<input type="checkbox"/>	MIM-R10UN
External contact control interface module ²		<input type="checkbox"/>	MIM-B14
Line sets - insulated and flared, interconnect cables included		<input type="checkbox"/>	25' - ILS2506
		<input type="checkbox"/>	50' - ILS5006
Wall bracket (for outdoor unit)		<input type="checkbox"/>	CKN-250
Wind Baffle / Guard	Front	<input type="checkbox"/>	WBF-3M
	Back	<input type="checkbox"/>	WBB-5M

¹ Sub-PCB model MIM-A00UN is required when connecting optional wired controllers or MIM-A60UN 24VAC thermostat adapter.

² When applying MIM-B14 external contact control interface module, MIM-A00UN wired controller sub-PCB is required.

provide with low ambient cooling to 0 degrees.

Samsung "WindFree™ 2.0e", wall mounted evaporator, split system
Indoor unit dimensional drawing

Unit: inches

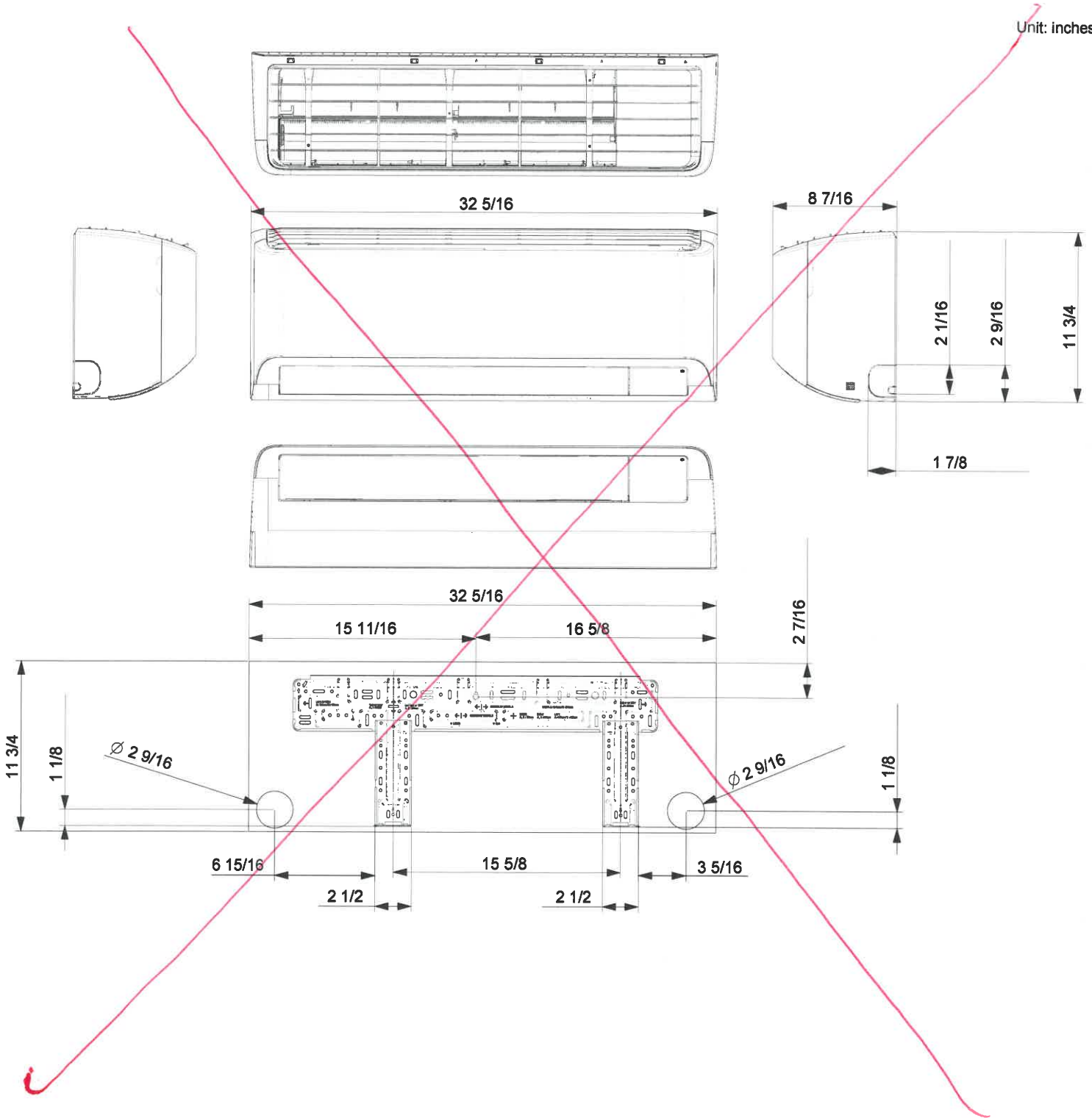

Unit: inches

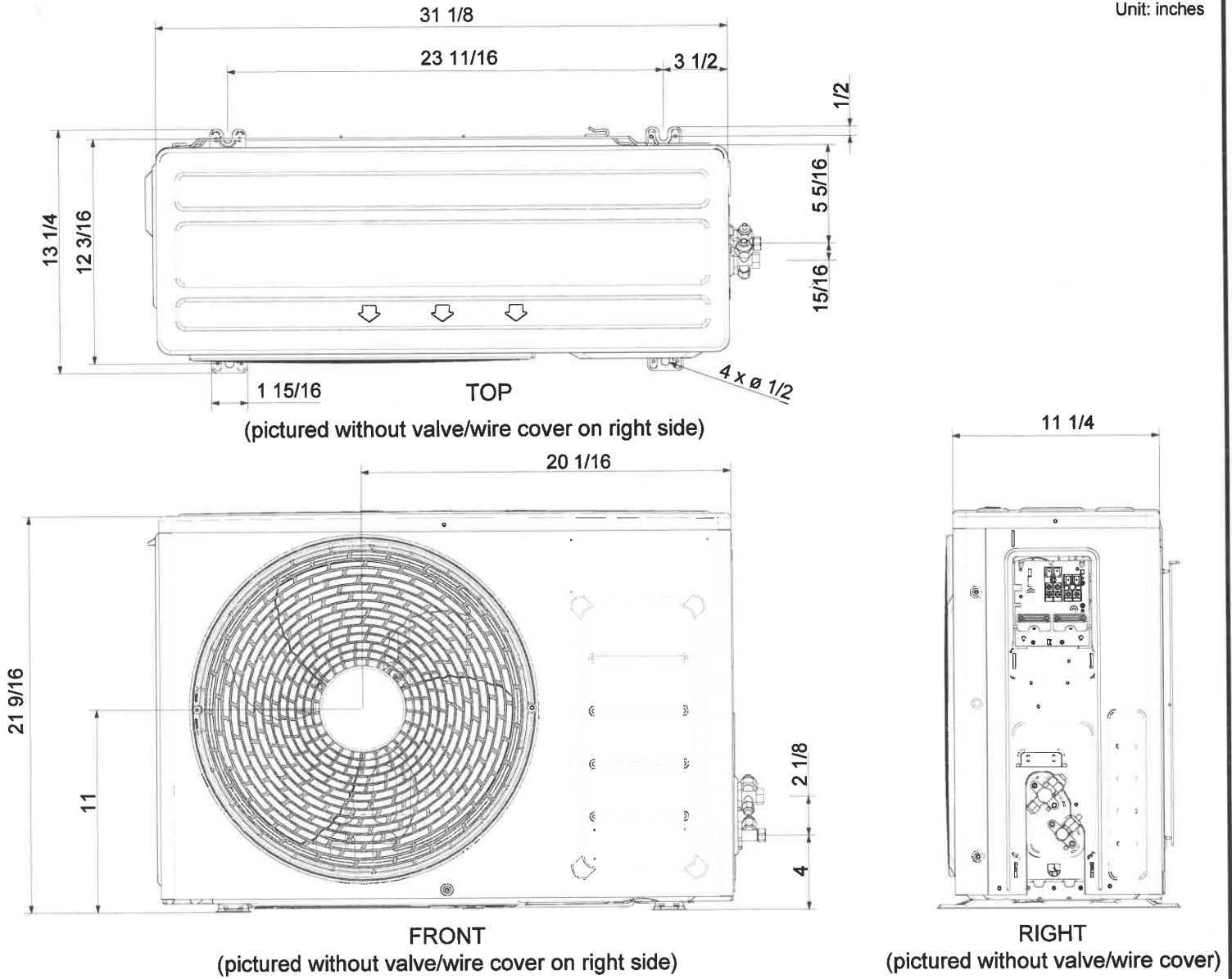

For reference only. Always refer to installation manual for complete details.

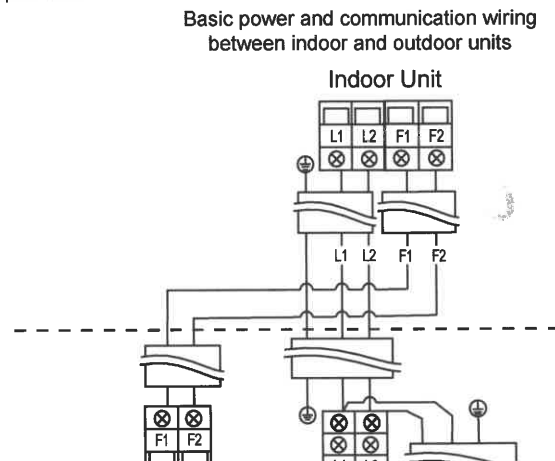
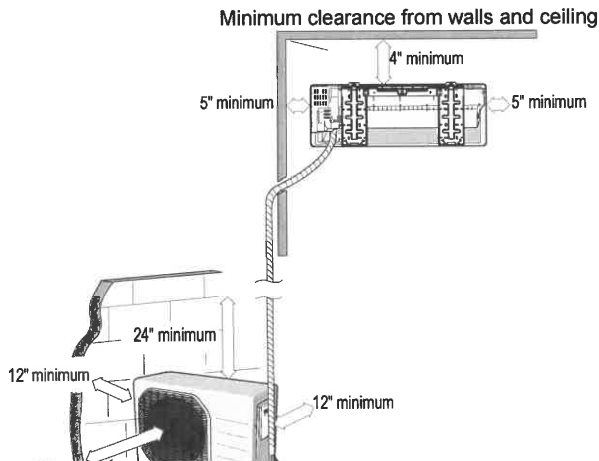



SUBMITTAL DATA SHEET

Maxi Orange

Mini-Split Condensate Pump Kit 100-250v
83919 (ASP-MAXO-UNI)

Project Information:

Job Name: Farm Credit

Location: Russellville, AR.

Engineer: HSA

Submitted to: CSUSA

For: Reference Approval Construction

Submitted by: Eric Blaylock

Reference:

Submittal Information:

Approval:

Date:

Construction:

Unit #:

Drawing #: AC-1

(Sec. I) Product Specifications:

Pump Length - 4.875"

Pump Width - 1.75"

Pump Height - 2.625"

Capacity - 8.9 GPH @ 0' Head / 1.5 GPH @ 49' Head

Max BTUs - 157,000 @ 115 v

Max Head in Feet - 49

Max Temperature - 104°F

Max Suction Lift - 5'

Sound Level - 35dB(A)

Dry Contact Rating - 3A NC

Voltage - 100 - 250v

Amperes - .15

Watts - 16

Remote Reservoir - Y

Plenum Rated - N

Cable Length - 5'

Pump Selector & Wiring Diagrams Available at
<http://www.rectorseal.com/aspenspump.html>

(Sec. II) Ordering Information:

Product Code - 83919

Model - ASPMAXOUNI

Carton Qty - 1

Carton Weight - 6

(Sec. III) Carton Contents:

Pump Assembly

Inline Reservoir

Submersible Reservoir

5"x1/4" i.d. Vinyl Discharge Tube

Modular 5' Power Cable

6"x1/4" i.d. Vinyl Breather Tube

Drain Hose Adaptor

Inline Fuse

Cable Ties (6)

Self Adhesive Velcro Strips (2)

8"x5/8" i.d. Inlet Tube

Installation Manual

Anti-Siphon Device

90° Elbow

(Fig. I) Product Image:



(Fig. II) Typical Pump Locations:

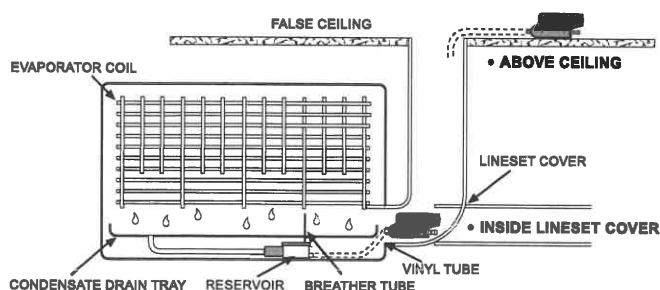

(RectorSeal's products are subject to continuous improvements; RectorSeal reserves the right to modify product design, specifications & information in this data sheet without notice and without incurring any obligations)

ASPEN® is a registered trademark of Aspen Oldco Limited Company UK

Maxi Orange

Mini-Split Condensate Pump Kit 100-250v
83819 (ASP-MAXO-UNI)

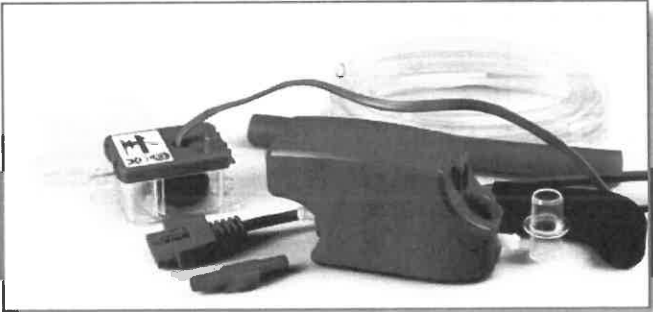

Aspen Pump BTU Calculator

Maxi Orange 115v 60Hz		
Head	GPH	BTU
0	9	157000
5	7.1	122000
10	6	103300
15	5	86100
20	4.2	72300
25	3.6	62000
30	3	52500
35	2.5	42600
40	2.2	37500
45	1.9	33250
49	1.5	25800

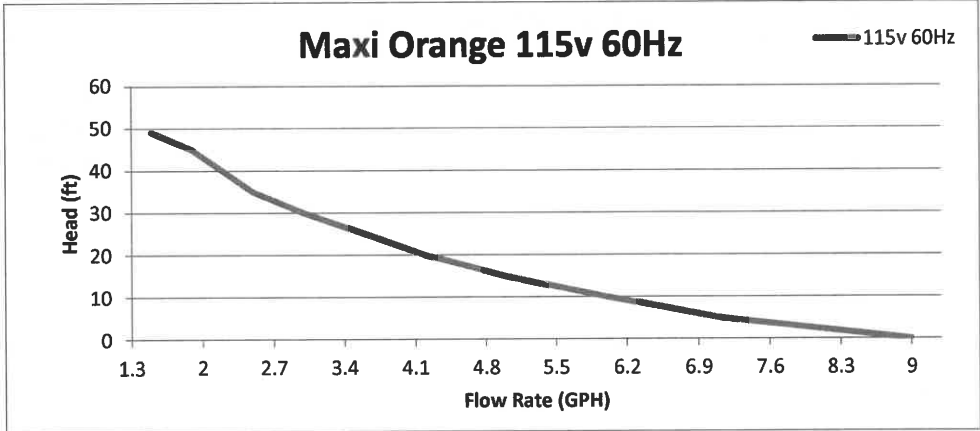

Maxi Orange 230v 60Hz		
Head	GPH	BTU
0	8	137850
5	6.3	108450
10	5.2	90000
15	4.5	77500
20	3.8	66500
25	3.2	54600
30	2.8	48000
35	2.4	42000
40	2	34000
45	1.7	29250
49	1.6	27500

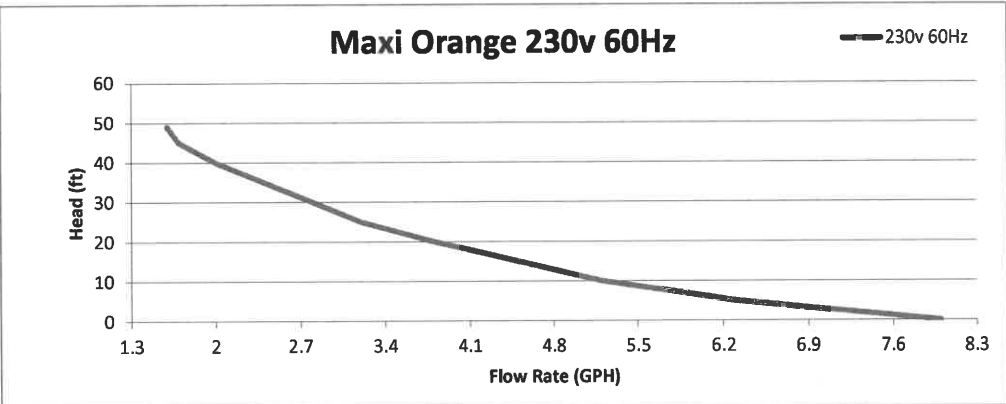

Pump Selector & Wiring Diagrams Available at
<http://www.rectorseal.com/aspenpump.html>

(RectorSeal's products are subject to continuous improvements; RectorSeal reserves the right to modify product design, specifications & information in this data sheet without notice and without incurring any obligations)
ASPEN® is a registered trademark of Aspen Oldco Limited Company UK



TO: Hight Jackson Associates
jandrade@hjarch.com

ATTN: Jorge Andrade

RE: Farm Credit - Russellville, AR
HVAC

DATE: 09/19/2023 JOB NO. 22-166

ELECTRONIC SUBMITTAL WAS REVIEWED AS FOLLOWS:

- | | | |
|--|---|---|
| <input checked="" type="checkbox"/> CUT SHEETS | <input type="checkbox"/> NO EXCEPTIONS TAKEN | <input checked="" type="checkbox"/> APPROVED |
| <input type="checkbox"/> DRAWINGS | <input checked="" type="checkbox"/> NOTE MARKINGS | <input type="checkbox"/> REJECTED |
| <input type="checkbox"/> OTHER | <input type="checkbox"/> COMMENTS ATTACHED | <input type="checkbox"/> RESUBMIT |
| | | <input type="checkbox"/> RESUBMIT only items marked |

REMARKS:

Submittal - 23 81 27-02 Small Split-System Heating Cooling

ENGINEER'S REVIEW IS FOR GENERAL CONFORMANCE WITH THE DESIGN CONCEPT AND CONTRACT DOCUMENT. MARKINGS OR COMMENTS SHALL NOT BE CONSTRUED AS RELIEVING THE CONTRACTOR FROM COMPLIANCE WITH THE PROJECT PLANS AND SPECIFICATIONS, NOR DEPARTURE THEREFROM. THE CONTRACTOR REMAINS RESPONSIBLE FOR DETAILS AND ACCURACY, FOR CONFIRMING AND CORRELATING ALL QUANTITIES AND DIMENSIONS, FOR SELECTING FABRICATION PROCESSES, FOR TECHNIQUES OF ASSEMBLY AND PERFORMING HIS WORK IN A SAFE MANNER.

Copies To:

 X File
 Owner
 X Architect
 Other BY: Nathan Wilson, PE

HSA Engineering Consulting Services, Inc.

7405 Ellis Street
Fort Smith, AR 72916

479.452.8922
www.hsaconsultants.com

SUBMITTAL



Project Name: Farm Credit
Project Number: 02-23-2720
Subcontractor: Comfort Systems
Specification: 23 81 27 - Small Split System
Submittal Number:

Construction Manager:

NABHOLZ CONSTRUCTION SERVICES	
<input type="checkbox"/>	Revise & Resubmit
<input checked="" type="checkbox"/>	Reviewed As Noted
<input type="checkbox"/>	Reviewed
By: <u>William Ray</u>	Date: <u>09/18/2023</u>

Original submittal has been approved - the indoor portion is being discontinued. The outdoor unit will stay the same.

Design Review Comments:

- | | |
|--|---|
| <input type="checkbox"/> APPROVED | <input type="checkbox"/> REVISE AND RESUBMIT |
| <input type="checkbox"/> APPROVED AS CORRECTED | <input type="checkbox"/> NOT APPROVED |
| <input checked="" type="checkbox"/> REVIEWED BY CONSULTANT | <input type="checkbox"/> SUPPLEMENTAL HJ COMMENTS |

Checking is only for conformance with the design concept of the Project and compliance with the information given in the Contract Documents. Contractor is responsible for dimensions to be confirmed and correlated at the job site, for information that pertains solely to the fabrication process or to the techniques of construction; and for coordination of the work of all trades.

BY: Jorge Andrade
9/20/2023
DATE: _____

Quality People. Building Solutions.

Comfort Systems USA (Arkansas), Inc.
P.O. Box 16620
Little Rock, AR 72231
Phone 501-834-3320
Fax 501-834-5416

Date: 9/18/2023
Return Request: 9/25/2023
Project: Farm Credit Office
Supplier: Split System
Submittal: Samsung
Submittal Number: 23 81 74-01
Drawing # and Installation: Mechanical Drawings

ARCHITECT

Hight Jackson
5201 W. Village Parkway, Suite 300
Rogers, AR 72758
479-464-4965

ENGINEER

HAS Engineering
7405 Ellis Rd.
Fort Smith, AR 72916
479-452-8922

GENERAL CONTRACTOR

Nabholz
612 Garland St.
Conway, AR 72032
501-505-5800

MECHANICAL SUBCONTRACTOR

Comfort Systems USA (Arkansas), Inc.
9924 Landers Rd.
N. Little Rock, AR 72117
501-834-3320

Notes:

*Submitting this unit due to original indoor wall ductless-split submitted & approved model being discontinued.

CSUSA PROJECT NO.

23-1013

jon@comfortar.com

Job Name FARM REDIT
 Purchaser CSUSA
 Submitted to JON DAVIS
 Unit Designation AC-1 ALTERNATE

Location RUSSELLVILLE
 Engineer HSA
 Reference Approval Construction
 Schedule # _____

Updated indoor unit model is approved. All other previous submittal review comments to remain.

Specifications

Model	US Code		RNS12CMC
	Model Number		AR12CSFCMWKNCV
Performance	Nominal Capacity	Cooling (Btu/h)	12,000
		Heating (Btu/h)	12,000
Power	Voltage	ø / V / Hz	1 / 208-230 / 60
	Operating Current (Max.)	Cooling (A)	0.3
		Heating (A)	0.3
Evaporator Fan	Type	BLDC motor with cross-flow fan	
	Consumption	Watts	27
	FLA	Amps	0.12
Airflow	Air Volume (L/MH/Turbo)	Cooling (CFM)	296 / 328 / 364 / 378
		Heating (CFM)	328 / 364 / 396 / 414
Refrigerant	Type	R410A	
	Control Method	Electronic Expansion Valve	
Pipe Connections	Indoor & Outdoor	High side (flare)	1/4"
		Low side (flare)	3/8"
	Condensate Connection	1 1/16" OD	
Dimensions	W X H X D (in.)	Indoor Unit	32-5/16 x 11-3/4 x 8-7/16
	Weight (lbs.)	Indoor Unit	19.6
Sound Pressure Level	Low / High	dB(A)	38 / 20
Accessories	Wired Controllers	Advanced	<input type="checkbox"/> MWR-WG00UN
		Simple Touch	<input type="checkbox"/> MWR-SH11UN
	Wired Controller Sub-PCB	<input type="checkbox"/> MIM-A00UN	
	24VAC Thermostat Adapter	<input type="checkbox"/> MIM-A60UN	
	Condensate Pump	Aspen Mini Orange	<input type="checkbox"/> ASP-MO-UNIV 110-250
		Blue Diamond	<input type="checkbox"/> BD-BLUE-230
	External Temperature Sensor	<input type="checkbox"/> MRW-TA	
	External Contact Control Card Interface	<input type="checkbox"/> MIM-B14	
	Line Sets - insulated and flared; interconnect cables included	<input type="checkbox"/> 25' - ILS2506	
<input type="checkbox"/> 50' - ILS5006			
Safety	Certifications	UL 60335-2-40	

General Information

- The indoor unit shall feature WindFree™* mode. In cooling mode, as room temperature nears set temperature, the unit will close its louver and will disperse air into the space through thousands of micro-holes on the front of the indoor unit preventing cold air drafts on occupants.
- The indoor unit shall have Wi-Fi capability as standard.
- The indoor unit shall be powered by the outdoor unit.

Construction

- Indoor unit chassis shall be UL94 V0 with a galvanized steel mounting bracket
- The indoor unit shall have easy-access to wire, pipe, and drain connections via access panel on the bottom of the unit for simple installation and service

Heat Exchanger

- The heat exchanger shall be mechanically bonded fin to copper tube

Indoor Fan

- The indoor fan shall be a single, antibacterial cross-flow type
- Three fan speed settings and auto setting
- Automatic (motorized) vertical swing (up/down) and horizontal swing (left/right) louvers

Controls

- The system shall have a built in Wi-Fi adapter as standard to allow control and monitoring using the Samsung SmartThings app (Android, iOS)
- Dual set temperature support when connected to MWR-WG00UN Advanced Wired Controller.
- The indoor unit shall have a simple connection for overflow detection devices or any other normally closed contact for simple unit shutdown
- The indoor unit shall ship with a wireless controller, holder, and batteries
- Wired controller options available
- Interconnect control wire between outdoor and indoor unit shall be 16AWG X 2

Convenience

- System energy consumption can be viewed using the Samsung SmartThings mobile app or on the indoor unit display using the included wireless controller**
- Auto Clean Function
- 7-segment digital display on front of unit to display temperature and unit status
- Auto changeover
- Good Sleep mode
- Quiet mode
- Dry mode
- Simple ON/OFF time function – Using the wireless controller specify the ON and/or OFF times
- Electro-static, washable, main filter as standard accessible from the top of unit
- Filter cleaning reminder

Compatibility

- Refer to the FJM outdoor unit submittal data or technical data book for complete compatibility listings.

*The WindFree™ unit delivers an air current that is under 0.15 m/s while in WindFree™ mode. Air velocity that is below 0.15 m/s is considered "still air" as defined by ASHRAE (American Society of Heating, Refrigerating, and Air Conditioning Engineers).

**For reference only; not revenue grade.

¹Sub-PCB model MIM-A00UN is required when connecting optional wired controllers or MIM-A60UM 24VAC thermostat adapter.

²When applying MIM-B14 external contact control interface module, MIM-A00UN wired controller sub-PCB is required.

Samsung HVAC maintains a policy of ongoing development. Specifications are subject to change without notice. Refer to www.AHRIdirectory.org for current reference numbers.



Samsung WindFree™ 3.0e, wall mounted evaporator
Indoor unit dimensional drawing

Unit: inches

