

REVISIONS		
NUMBER	DATE	DESCRIPTION
1	03/15/23	Addendum 1
2	06/29/23	Addendum 2

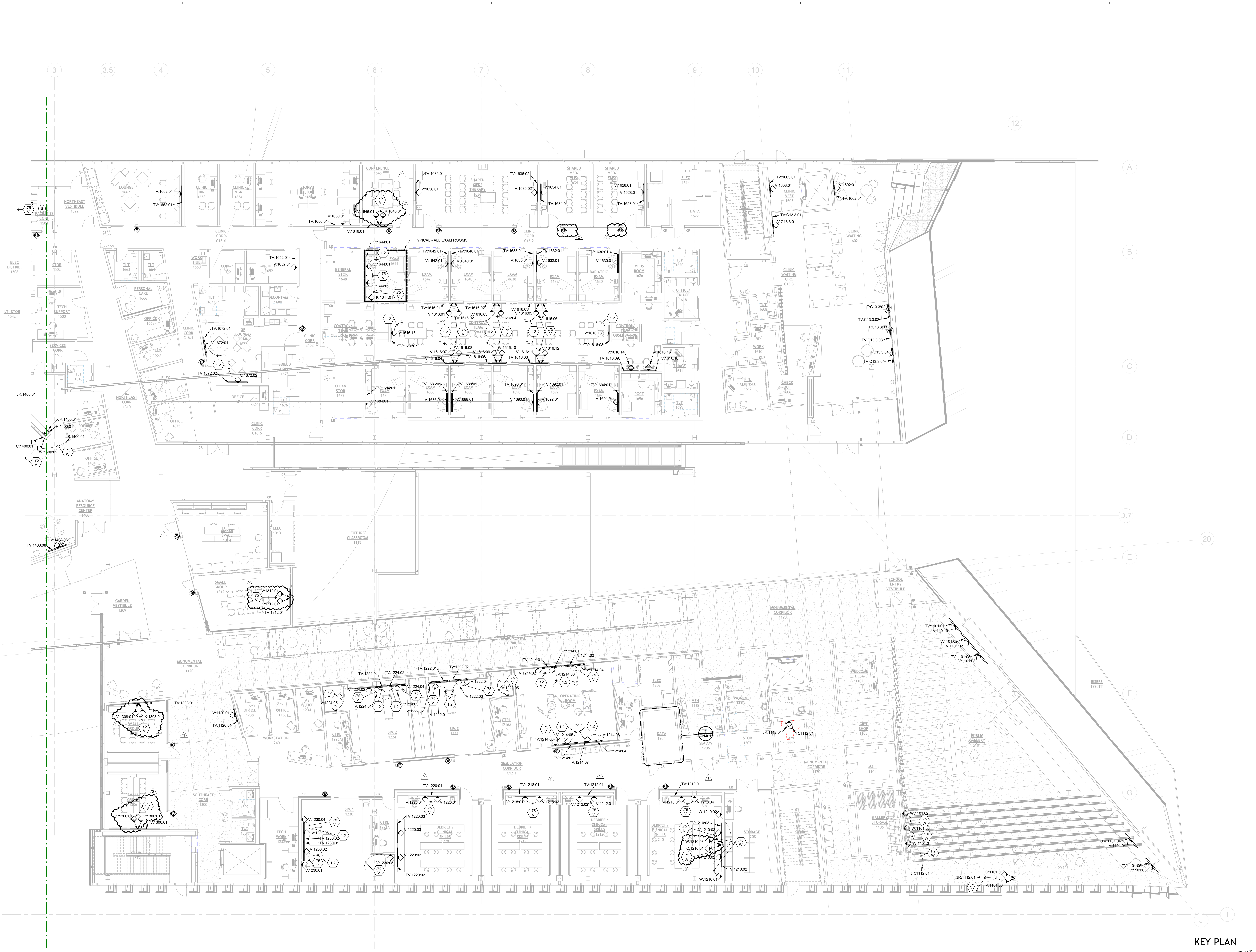

1 AUDIO-VIDEO - LEVEL 1 PLAN - AREA A
1/8" = 1'-0"

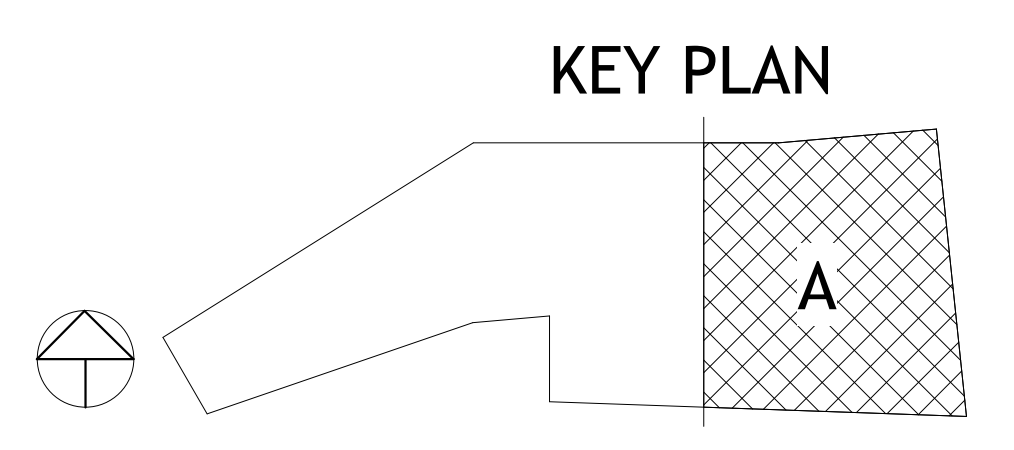

PSW Job Number:
993A

Henderson Job Number:
2150002607



AWSOM
Bentonville, AR

Issue Date:
02.24.2023

REVISIONS		
NUMBER	DATE	DESCRIPTION
2	06/23	As shown 2

Consents:
**AUDIO-VIDEO -
LEVEL 1 PLAN -
AREA B**

THIS PAGE IS BEST
VIEWED IN COLOR
TA101B

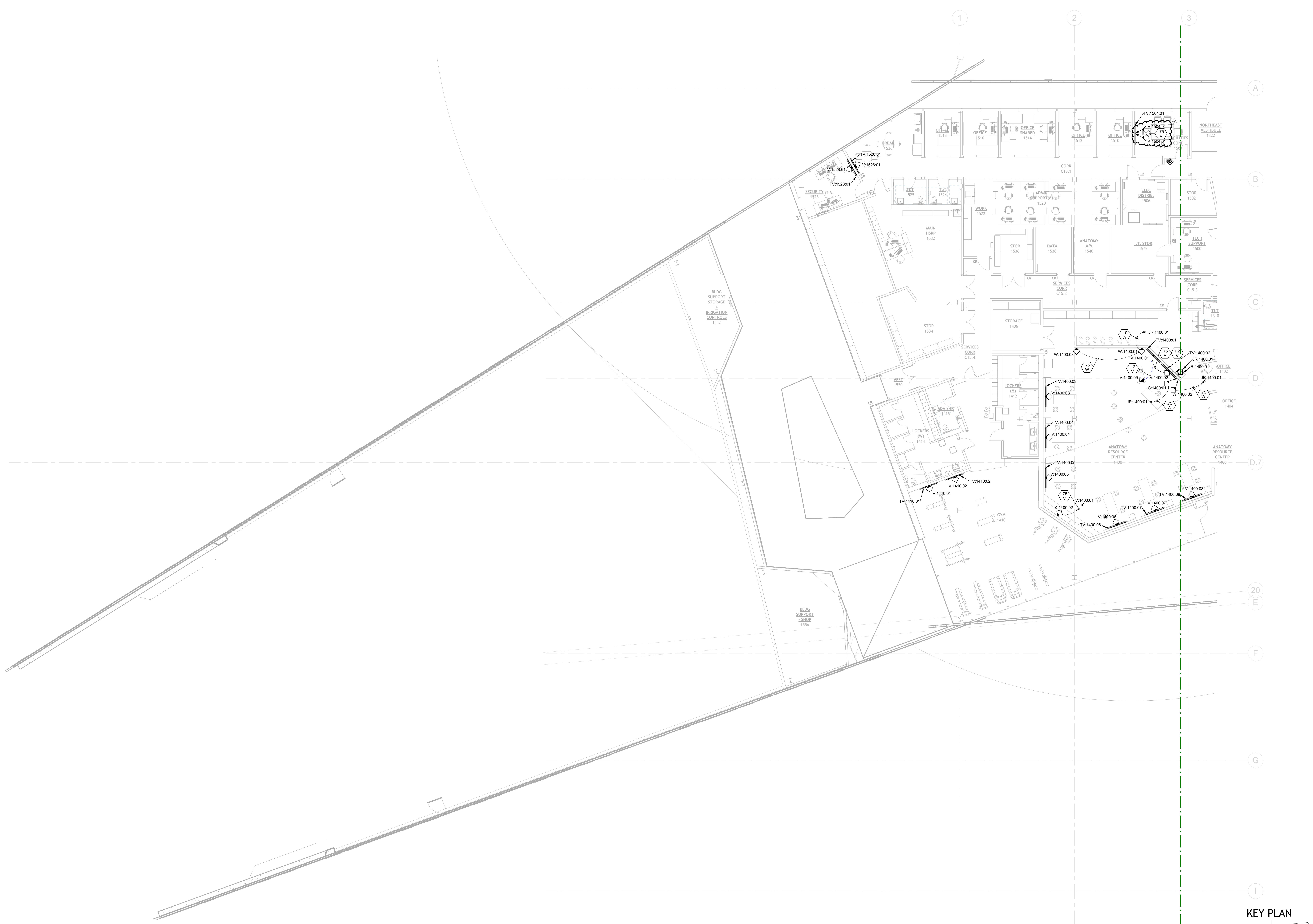

1 AUDIO-VIDEO - LEVEL 1 PLAN - AREA B
1/8" = 1'-0"

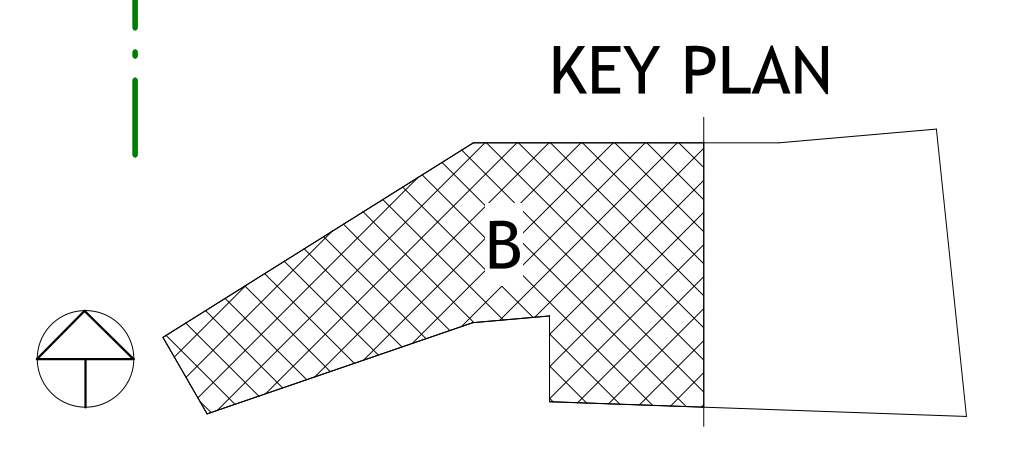

PSW Job Number:
993A

Henderson Job Number:
2150002607



AWSOM
Bentonville, AR

Issue Date:
02.24.2023

REVISIONS		
NUMBER	DATE	DESCRIPTION
1	03.15.23	Addendum 1
2	06.29.23	Addendum 2

Consents:
AUDIO-VIDEO -
LEVEL 2 PLAN -
AREA A

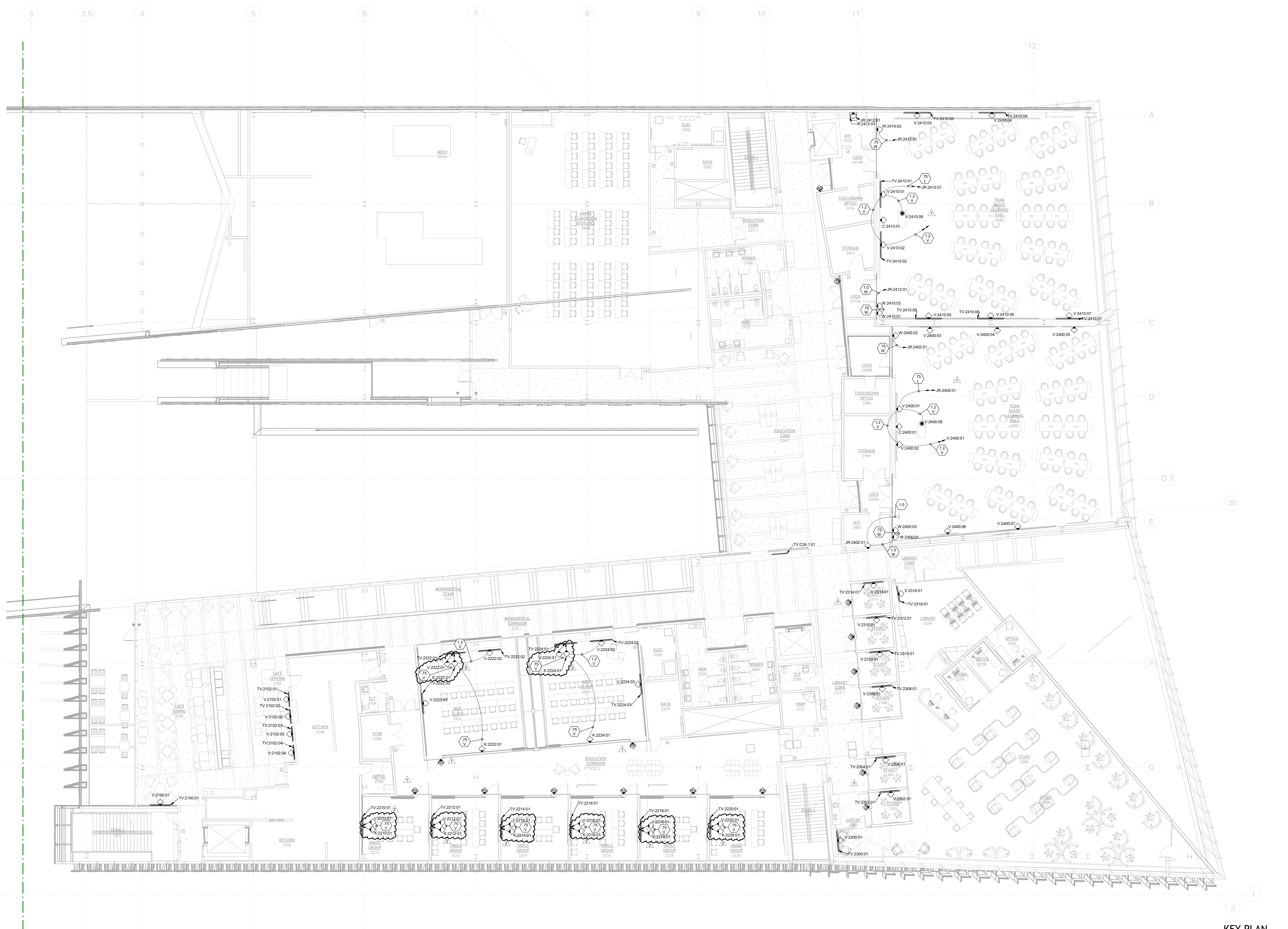

1 AUDIO-VIDEO - LEVEL 2 PLAN - AREA A
1/8" = 1'-0"

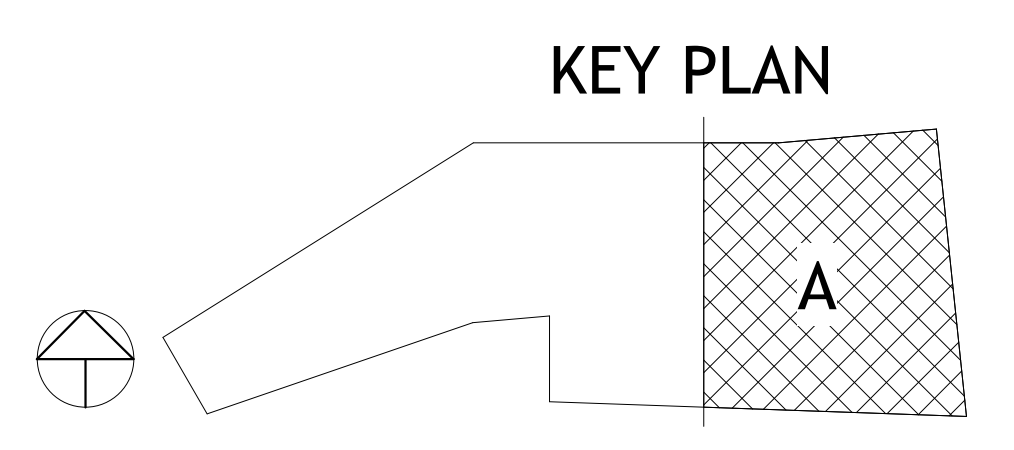

PSW Job Number:
993A
Henderson Job Number:
2150002607

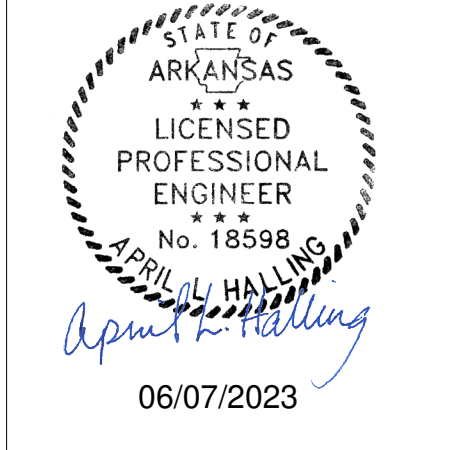

AWSOM
Bentonville, AR

Issue Date:
02.24.2023

REVISIONS		
NUMBER	DATE	DESCRIPTION
1	03/10/23	Addendum 1
2	06/29/23	Addendum 2

Contents:
AUDIO-VIDEO -
LEVEL 3 PLAN -
AREA A

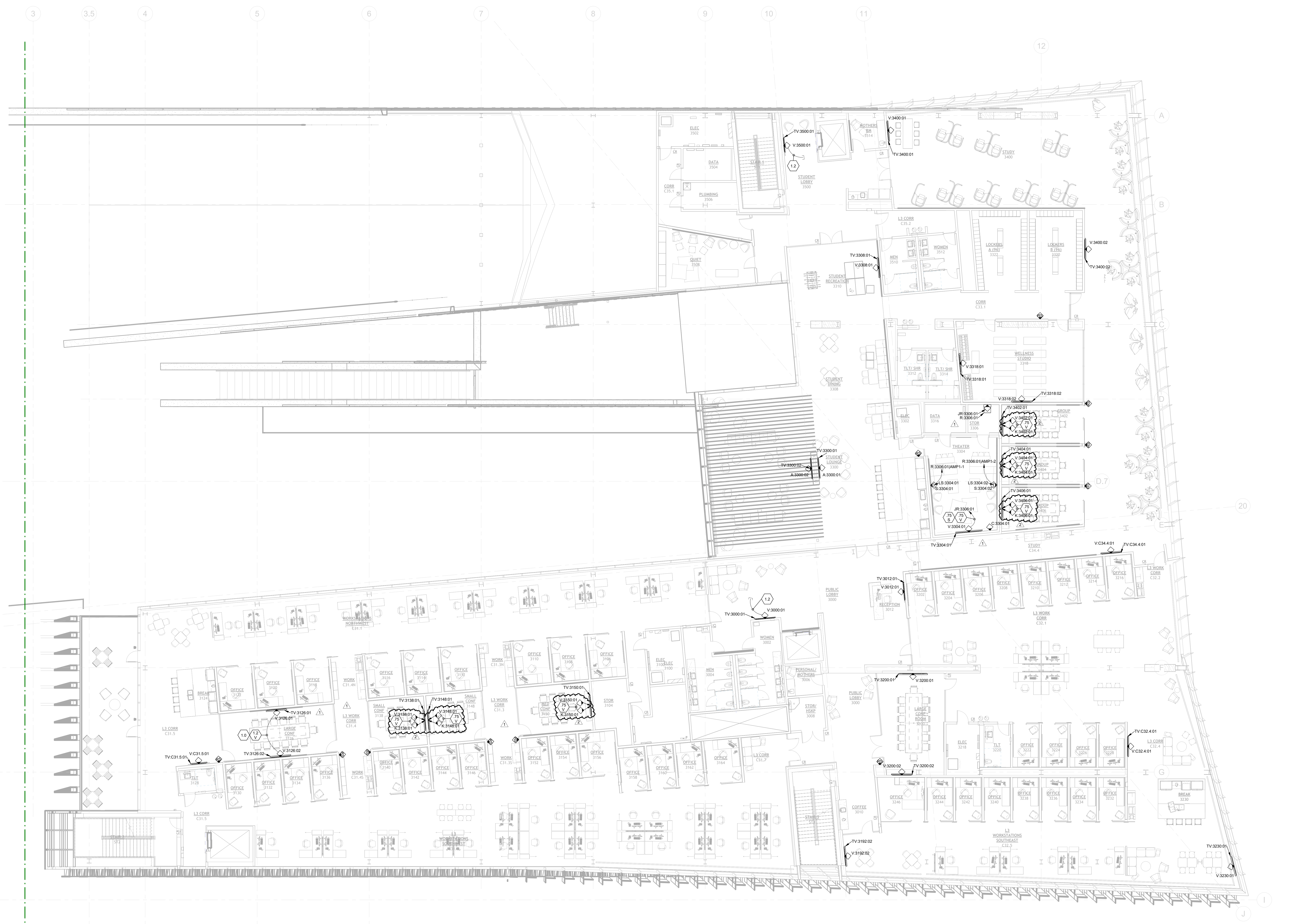

1 AUDIO-VIDEO - LEVEL 3 PLAN - AREA A
1/8" = 1'-0"

KEY PLAN

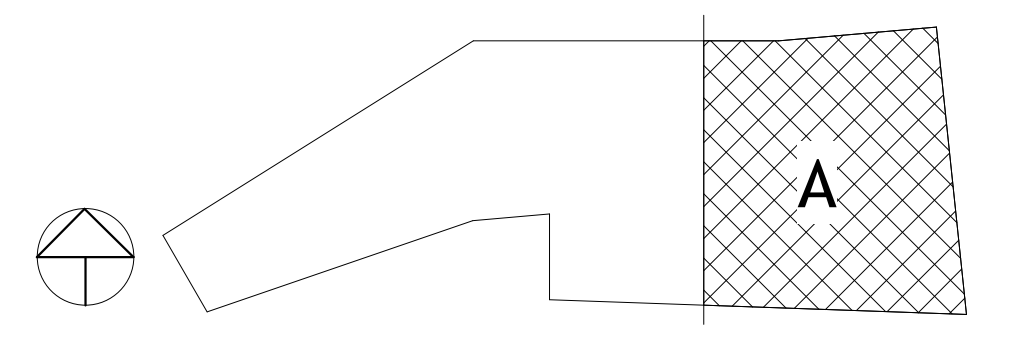

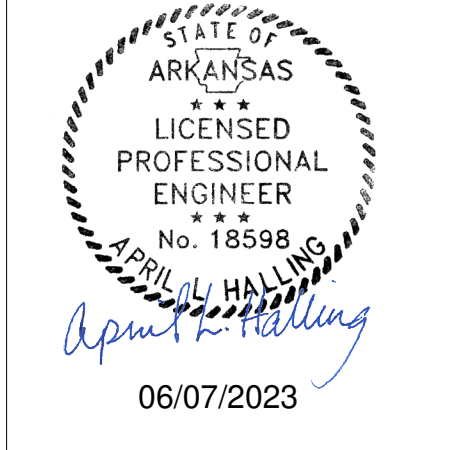

REVISIONS		
NUMBER	DATE	DESCRIPTION
1	03/13/23	Addendum 1
2	06/29/23	Addendum 2

Contents:
AUDIO-VIDEO -
LEVEL 1 RCP -
AREA A

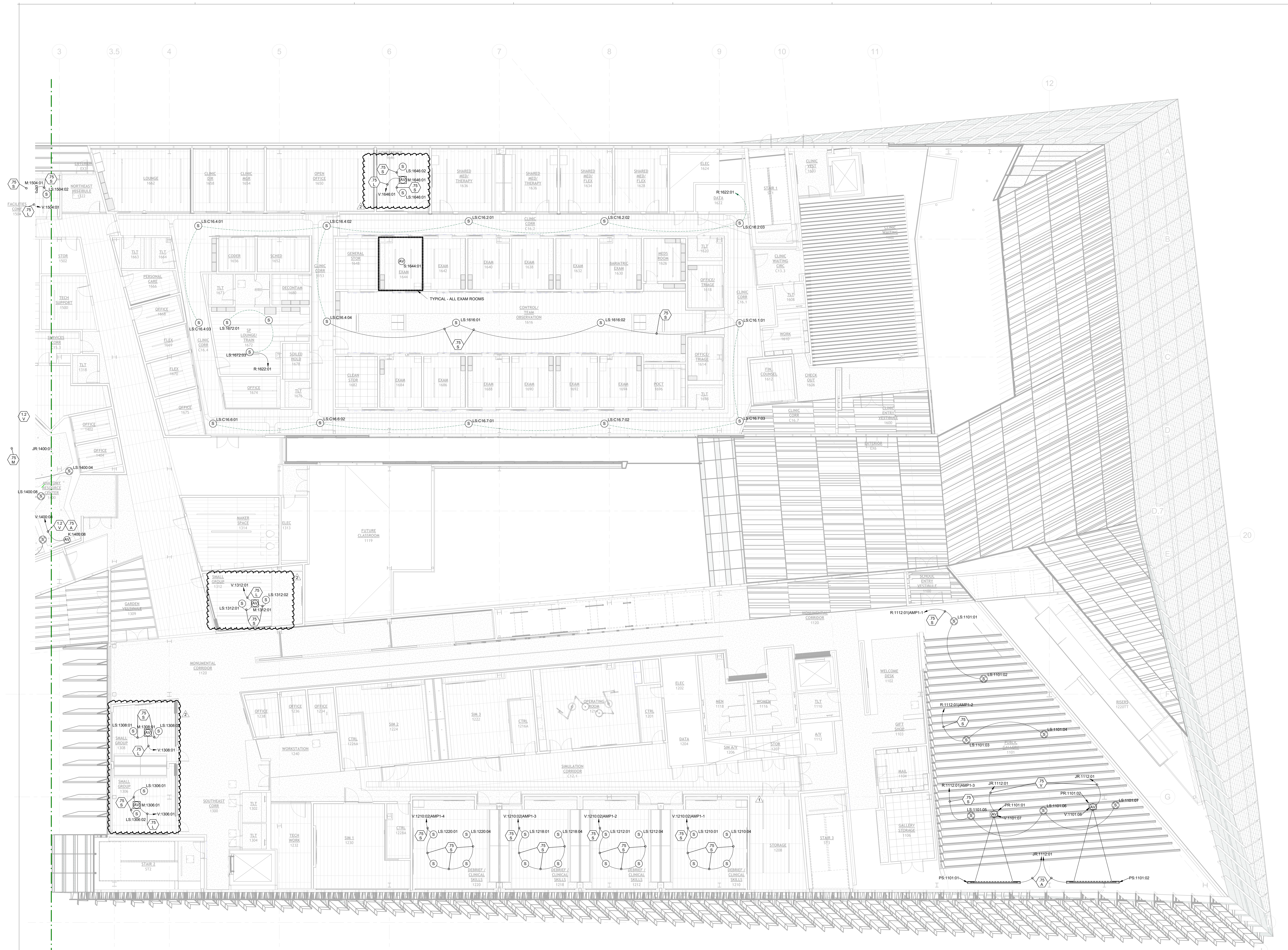

1 AUDIO-VIDEO - LEVEL 1 RCP - AREA A
1/8" = 1'-0"

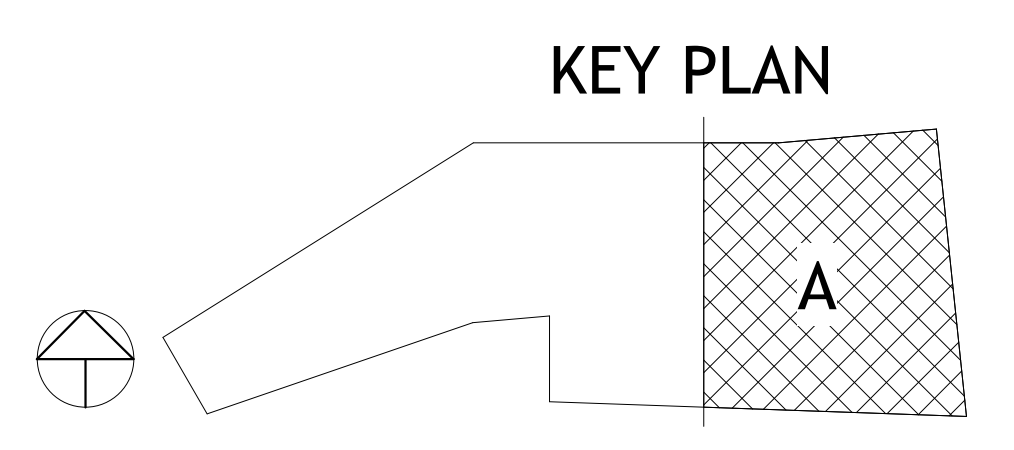

PSW Job Number:
993A
Henderson Job Number:
2150002607

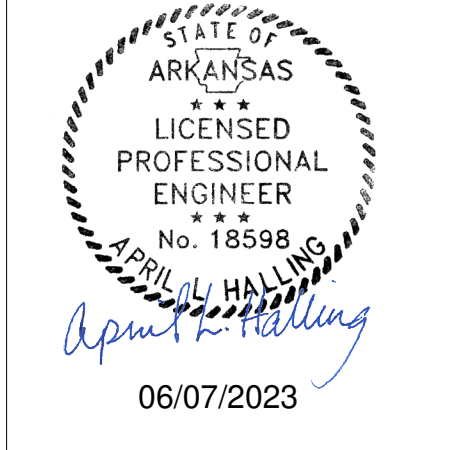

AWSOM
Bentonville, AR

Issue Date:
02.24.2023

REVISIONS		
NUMBER	DATE	DESCRIPTION
1	03.10.23	Addendum 1
2	06.09.23	Addendum 2

Consents:
AUDIO-VIDEO -
LEVEL 2 RCP -
AREA A

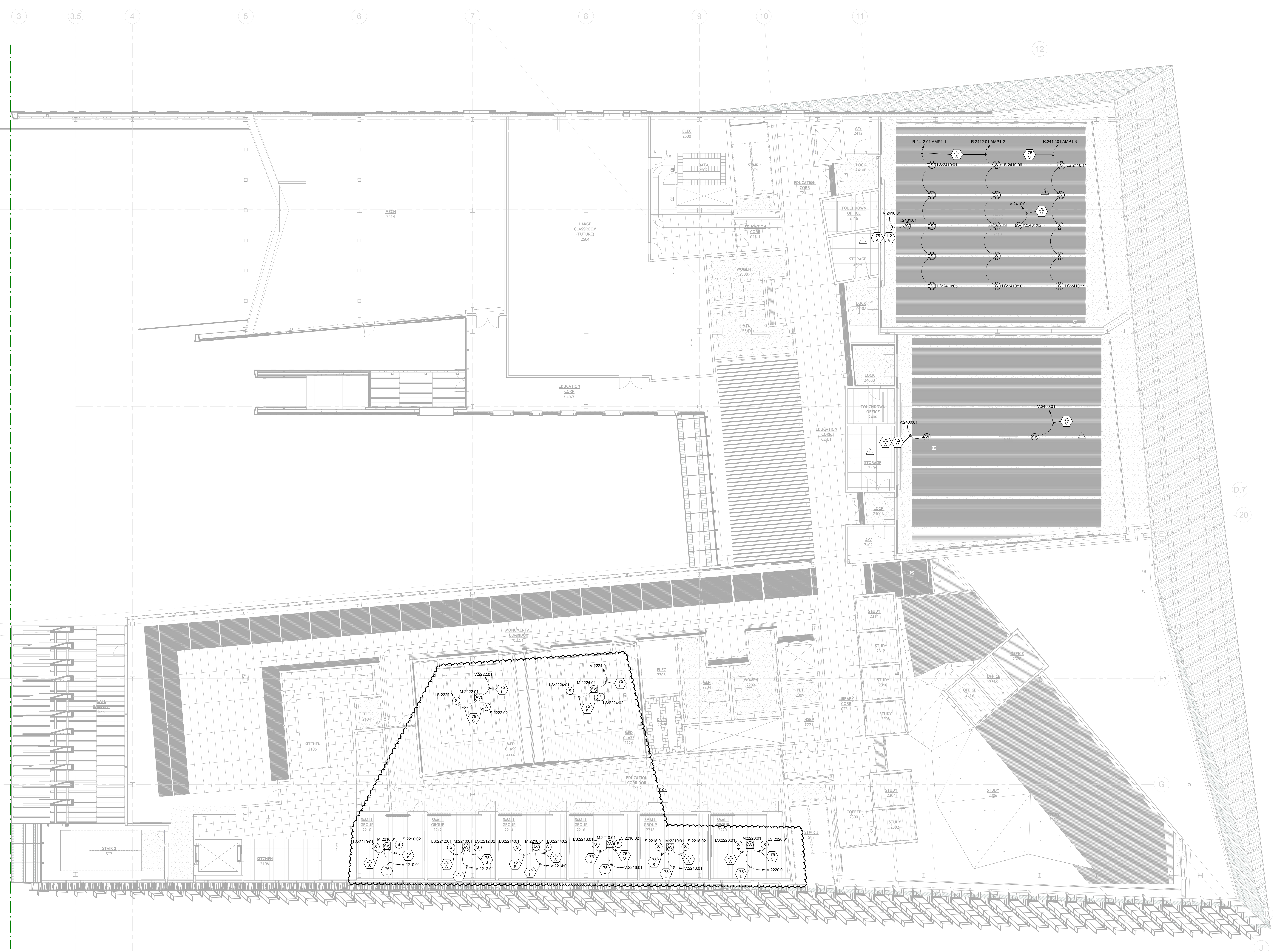

Ⓢ AUDIO-VIDEO - LEVEL 2 RCP - AREA A
1/8" = 1'-0"

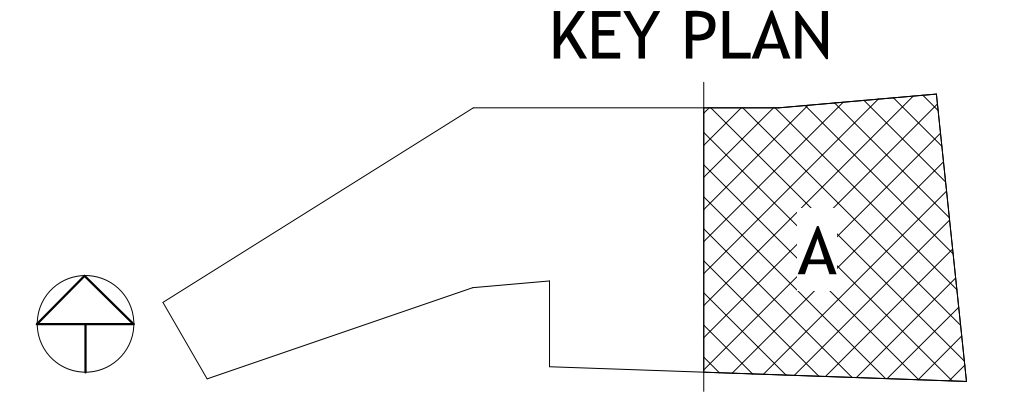

PSW Job Number:
993A

Henderson Job Number:
2150002607

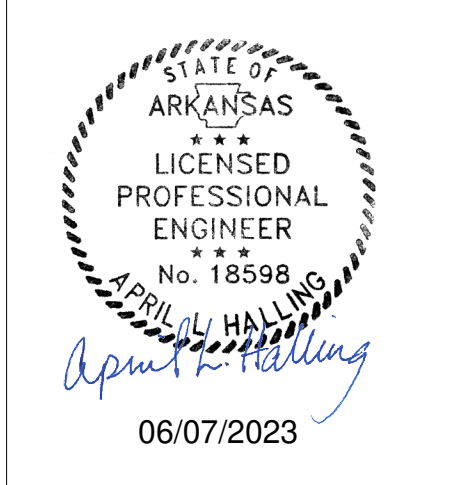

AWSOM
Bentonville, AR

Issue Date:
02.24.2023

REVISIONS		
NUMBER	DATE	DESCRIPTION
1	03/15/23	Addendum 1
2	06/29/23	Addendum 2

Contents:
AUDIO-VIDEO - LEVEL 3 RCP - AREA A

1 AUDIO-VIDEO - LEVEL 3 RCP - AREA A
1/8" = 1'-0"

KEY PLAN

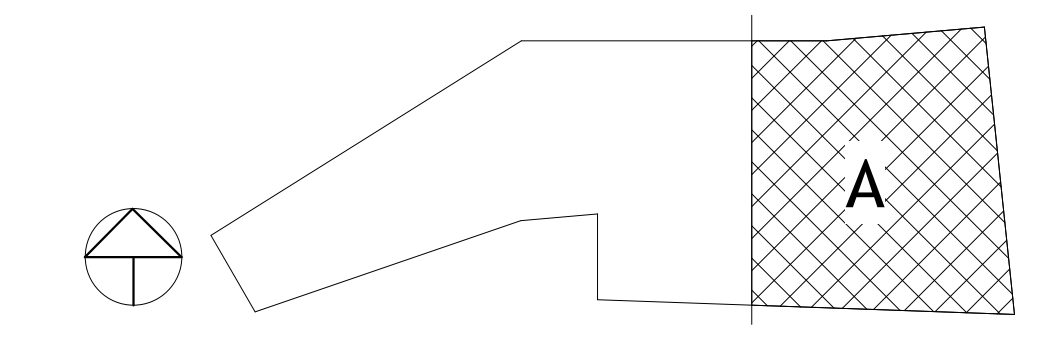

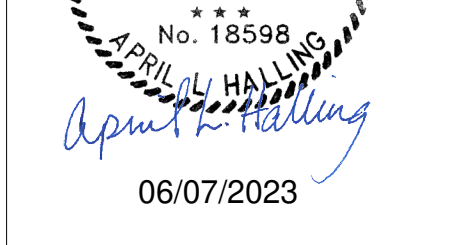

REVISIONS	
NUMBER	DESCRIPTION
1	03/15/23 Addendum 1
2	06/29/23 Addendum 2

AUDIO-VIDEO BOX SCHEDULE - TYPICALS

BOX FUNCTION		BOX PROPERTIES			BOX ACCESSORIES			CONDUIT REQUIREMENTS		NOTES
ID	DESCRIPTION	TYPE	B.O.D. MANUF.	B.O.D. MODEL	INSTALL HEIGHT (CENTER OF BOX)	MOUNTING	COVER	INSERTS	ROUTE	
RS	ROOM SCHEDULER WALL BOX	2-GANG/2-GANG	RACO	260 W/ 818	FLUSH	FLUSH	BLANK	2-GANG MUD RING	STUBBED UP TO ACCESSIBLE CEILING	CONTRACTOR FURNISHED & INSTALLED
AUDIO-VIDEO BOX SCHEDULE 1of3										
ID	DESCRIPTION	TYPE	B.O.D. MANUF.	B.O.D. MODEL	INSTALL HEIGHT (CENTER OF BOX)	MOUNTING	COVER	INSERTS		NOTES
A.3300-01	ASSORTED CONNECTION WALL BOX	FLUSH WALL BOX 14X14	LEGRAND	WMPAC526FCWP4	16"	FLUSH	PROVIDE			PROVIDE ONE LEGRAND WMPACL2 ATTACHMENT PLATE
A.3300-02	ASSORTED CONNECTION WALL BOX	FLUSH WALL BOX 14X14	LEGRAND	WMPAC526FCWP4	16"	FLUSH	PROVIDE			PROVIDE ONE LEGRAND WMPACL2 ATTACHMENT PLATE
C.1101-01	VOLUME CONTROL / SOURCE SELECT CONTROL WALL BOX	2-GANG	RACO	260	48"	SURFACE	BLANK			NONE
C.1210-01	ASSORTED CONNECTION WALL BOX	2-GANG/1-GANG	RACO	260 W/ 843	48"	FLUSH	BLANK			1-GANG MUD RING
C.1400-01	VOLUME CONTROL WALL BOX	2-GANG/1-GANG	RACO	260 W/ 843	48"	FLUSH	BLANK			1-GANG MUD RING
C.2400-01	VOLUME CONTROL / SOURCE SELECT CONTROL WALL BOX	2-GANG/2-GANG	RACO	260 W/ 818	48"	FLUSH	BLANK			1-GANG MUD RING
C.2410-01	VOLUME CONTROL / SOURCE SELECT CONTROL WALL BOX	2-GANG/2-GANG	RACO	260 W/ 818	48"	FLUSH	BLANK			1-GANG MUD RING
C.3304-01	ASSORTED CONNECTION WALL BOX	2-GANG	RACO	260	48"	FLUSH	BLANK			NONE
JR.1112-01	EQUIPMENT RACK JUNCTION BOX	NEMA 12x12x04	HOFFMAN	ASG12X12X4	56"	FLUSH	PROVIDE			NONE
JR.1400-01	EQUIPMENT RACK JUNCTION BOX	NEMA 12x12x04	HOFFMAN	ASG12X12X4	22"	FLUSH	PROVIDE			NONE
JR.2402-01	ASSORTED CONNECTION WALL BOX	NEMA 12x12x04	HOFFMAN	ASG12X12X4	22"	FLUSH	PROVIDE			NONE
JR.2412-01	EQUIPMENT RACK JUNCTION BOX	NEMA 12x12x04	HOFFMAN	ASG12X12X4	56"	FLUSH	PROVIDE			NONE
JR.3306-01	ASSORTED CONNECTION WALL BOX	NEMA 12x12x04	HOFFMAN	ASG12X12X4	56"	FLUSH	PROVIDE			NONE
S.1644-01	CEILING SPEAKER BOX	1-GANG	RACO	256 W/ 768	0"	CEILING FLUSH	BLANK			1-GANG MUD RING
S.3304-01	ASSORTED CONNECTION WALL BOX	2-GANG/1-GANG	RACO	260 W/ 843	72"	FLUSH	BLANK			1-GANG MUD RING
S.3304-02	ASSORTED CONNECTION WALL BOX	2-GANG/1-GANG	RACO	260 W/ 843	72"	FLUSH	BLANK			1-GANG MUD RING
T.C13.3.02	ASSORTED CONNECTION CEILING BOX	1-GANG	RACO	256 W/ 768	0"	CEILING FLUSH	BLANK			1-GANG MUD RING
T.C13.3.03	ASSORTED CONNECTION CEILING BOX	1-GANG	RACO	256 W/ 768	0"	CEILING FLUSH	BLANK			1-GANG MUD RING
T.C13.3.04	ASSORTED CONNECTION CEILING BOX	1-GANG	RACO	256 W/ 768	0"	CEILING FLUSH	BLANK			1-GANG MUD RING
V.1101-01	FLAT PANEL DISPLAY WALL BOX	FLUSH WALL BOX 14X14	LEGRAND	WMPAC526FCWP4	118"	FLUSH	PROVIDE			ELECTRICAL RECEPTACLES AND DATA PORTS SHALL RESIDE IN THIS BOX. REFER TO ELECTRICAL AND TELECOMMUNICATIONS DRAWINGS FOR CIRCUITING AND PORT COUNT REQUIREMENTS.
V.1101-02	FLAT PANEL DISPLAY WALL BOX	FLUSH WALL BOX 14X14	LEGRAND	WMPAC526FCWP4	118"	FLUSH	PROVIDE			ELECTRICAL RECEPTACLES AND DATA PORTS SHALL RESIDE IN THIS BOX. REFER TO ELECTRICAL AND TELECOMMUNICATIONS DRAWINGS FOR CIRCUITING AND PORT COUNT REQUIREMENTS.
V.1101-03	FLAT PANEL DISPLAY WALL BOX	FLUSH WALL BOX 14X14	LEGRAND	WMPAC526FCWP4	118"	FLUSH	PROVIDE			ELECTRICAL RECEPTACLES AND DATA PORTS SHALL RESIDE IN THIS BOX. REFER TO ELECTRICAL AND TELECOMMUNICATIONS DRAWINGS FOR CIRCUITING AND PORT COUNT REQUIREMENTS.
V.1101-04	FLAT PANEL DISPLAY WALL BOX	FLUSH WALL BOX 14X14	LEGRAND	WMPAC526FCWP4	118"	FLUSH	PROVIDE			ELECTRICAL RECEPTACLES AND DATA PORTS SHALL RESIDE IN THIS BOX. REFER TO ELECTRICAL AND TELECOMMUNICATIONS DRAWINGS FOR CIRCUITING AND PORT COUNT REQUIREMENTS.
V.1101-05	FLAT PANEL DISPLAY WALL BOX	FLUSH WALL BOX 14X14	LEGRAND	WMPAC526FCWP4	118"	FLUSH	PROVIDE			ELECTRICAL RECEPTACLES AND DATA PORTS SHALL RESIDE IN THIS BOX. REFER TO ELECTRICAL AND TELECOMMUNICATIONS DRAWINGS FOR CIRCUITING AND PORT COUNT REQUIREMENTS.
V.1101-06	LAPTOP OR VIDEO CONNECTION WALL BOX	2-GANG	RACO	260	18"	SURFACE	BLANK			NONE
V.1101-07	VIDEO PROJECTOR CONNECTION CEILING BOX	2-GANG	RACO	260	0"	CEILING FLUSH	BLANK			NONE
V.1101-08	VIDEO PROJECTOR CONNECTION CEILING BOX	2-GANG	RACO	260	0"	CEILING FLUSH	BLANK			NONE
V.1120-01	FLAT PANEL DISPLAY WALL BOX	FLUSH WALL BOX 14X14	LEGRAND	WMPAC526FCWP4	65"	FLUSH	PROVIDE			ELECTRICAL RECEPTACLES AND DATA PORTS SHALL RESIDE IN THIS BOX. REFER TO ELECTRICAL AND TELECOMMUNICATIONS DRAWINGS FOR CIRCUITING AND PORT COUNT REQUIREMENTS.
V.1210-01	ASSORTED CONNECTION WALL BOX	FLUSH WALL BOX 14X14	LEGRAND	WMPAC526FCWP4	84"	FLUSH	PROVIDE			PROVIDE ONE LEGRAND WMPACL2 ATTACHMENT PLATE
V.1210-02	ASSORTED CONNECTION WALL BOX	FLUSH WALL BOX 14X14	LEGRAND	WMPAC526FCWP4	84"	FLUSH	PROVIDE			PROVIDE ONE LEGRAND WMPACL2 ATTACHMENT PLATE
V.1210-03	ASSORTED CONNECTION WALL BOX	FLUSH WALL BOX 14X14	LEGRAND	WMPAC526FCWP4	84"	FLUSH	PROVIDE			PROVIDE ONE LEGRAND WMPACL2 ATTACHMENT PLATE
V.1210-04	ASSORTED CONNECTION WALL BOX	2-GANG/1-GANG	RACO	260 W/ 843	42"	FLUSH	BLANK			1-GANG MUD RING
V.1212-01	ASSORTED CONNECTION WALL BOX	FLUSH WALL BOX 14X14	LEGRAND	WMPAC526FCWP4	84"	FLUSH	PROVIDE			PROVIDE ONE LEGRAND WMPACL2 ATTACHMENT PLATE
V.1212-02	ASSORTED CONNECTION WALL BOX	2-GANG/1-GANG	RACO	260 W/ 843	42"	FLUSH	BLANK			1-GANG MUD RING
V.1214-01	ASSORTED CONNECTION WALL BOX	FLUSH WALL BOX 14X14	LEGRAND	WMPAC526FCWP4	92"	FLUSH	PROVIDE			PROVIDE ONE LEGRAND WMPACL2 ATTACHMENT PLATE
V.1214-02	ASSORTED CONNECTION WALL BOX	2-GANG/1-GANG	RACO	260 W/ 843	18"	FLUSH	BLANK			2-GANG MUD RING
V.1214-03	ASSORTED CONNECTION WALL BOX	FLUSH WALL BOX 14X14	LEGRAND	WMPAC526FCWP4	92"	FLUSH	PROVIDE			PROVIDE ONE LEGRAND WMPACL2 ATTACHMENT PLATE
V.1214-04	ASSORTED CONNECTION WALL BOX	2-GANG/1-GANG	RACO	260 W/ 843	18"	FLUSH	BLANK			2-GANG MUD RING
V.1214-05	ASSORTED CONNECTION WALL BOX	FLUSH WALL BOX 14X14	LEGRAND	WMPAC526FCWP4	92"	FLUSH	PROVIDE			PROVIDE ONE LEGRAND WMPACL2 ATTACHMENT PLATE
V.1214-06	ASSORTED CONNECTION WALL BOX	2-GANG/1-GANG	RACO	260 W/ 843	18"	FLUSH	BLANK			2-GANG MUD RING
V.1214-07	ASSORTED CONNECTION WALL BOX	FLUSH WALL BOX 14X14	LEGRAND	WMPAC526FCWP4	92"	FLUSH	PROVIDE			PROVIDE ONE LEGRAND WMPACL2 ATTACHMENT PLATE
V.1214-08	ASSORTED CONNECTION WALL BOX	2-GANG/1-GANG	RACO	260 W/ 843	18"	FLUSH	BLANK			2-GANG MUD RING
V.1218-01	ASSORTED CONNECTION WALL BOX	FLUSH WALL BOX 14X14	LEGRAND	WMPAC526FCWP4	84"	FLUSH	PROVIDE			PROVIDE ONE LEGRAND WMPACL2 ATTACHMENT PLATE
V.1218-02	ASSORTED CONNECTION WALL BOX	2-GANG/1-GANG	RACO	260 W/ 843	42"	FLUSH	BLANK			1-GANG MUD RING
V.1220-01	ASSORTED CONNECTION WALL BOX	FLUSH WALL BOX 14X14	LEGRAND	WMPAC526FCWP4	84"	FLUSH	PROVIDE			PROVIDE ONE LEGRAND WMPACL2 ATTACHMENT PLATE
V.1220-02	ASSORTED CONNECTION WALL BOX	FLUSH WALL BOX 14X14	LEGRAND	WMPAC526FCWP4	84"	FLUSH	PROVIDE			PROVIDE ONE LEGRAND WMPACL2 ATTACHMENT PLATE
V.1220-03	ASSORTED CONNECTION WALL BOX	FLUSH WALL BOX 14X14	LEGRAND	WMPAC526FCWP4	84"	FLUSH	PROVIDE			PROVIDE ONE LEGRAND WMPACL2 ATTACHMENT PLATE
V.1220-04	ASSORTED CONNECTION WALL BOX	2-GANG/1-GANG	RACO	260 W/ 843	42"	FLUSH	BLANK			1-GANG MUD RING
V.1230-01	ASSORTED CONNECTION WALL BOX	2-GANG/1-GANG	RACO	260 W/ 843	18"	FLUSH	BLANK			2-GANG MUD RING
V.1230-02	ASSORTED CONNECTION WALL BOX	FLUSH WALL BOX 14X14	LEGRAND	WMPAC526FCWP4	90"	FLUSH	PROVIDE			PROVIDE ONE LEGRAND WMPACL2 ATTACHMENT PLATE
V.1230-03	ASSORTED CONNECTION WALL BOX	FLUSH WALL BOX 14X14	LEGRAND	WMPAC526FCWP4	90"	FLUSH	PROVIDE			PROVIDE ONE LEGRAND WMPACL2 ATTACHMENT PLATE
V.1230-04	ASSORTED CONNECTION WALL BOX	2-GANG/1-GANG	RACO	260 W/ 843	18"	FLUSH	BLANK			2-GANG MUD RING
V.1230-05	ASSORTED CONNECTION WALL BOX	2-GANG/1-GANG	RACO	260 W/ 843	18"	FLUSH	BLANK			2-GANG MUD RING
V.1306-01	FLAT PANEL DISPLAY WALL BOX	FLUSH WALL BOX 14X14	LEGRAND	WMPAC526FCWP4	66"	FLUSH	PROVIDE			ELECTRICAL RECEPTACLES AND DATA PORTS SHALL RESIDE IN THIS BOX. REFER TO ELECTRICAL AND TELECOMMUNICATIONS DRAWINGS FOR CIRCUITING AND PORT COUNT REQUIREMENTS.
V.1308-01	FLAT PANEL DISPLAY WALL BOX	FLUSH WALL BOX 14X14	LEGRAND	WMPAC526FCWP4	66"	FLUSH	PROVIDE			ELECTRICAL RECEPTACLES AND DATA PORTS SHALL RESIDE IN THIS BOX. REFER TO ELECTRICAL AND TELECOMMUNICATIONS DRAWINGS FOR CIRCUITING AND PORT COUNT REQUIREMENTS.
V.1312-01	FLAT PANEL DISPLAY WALL BOX	FLUSH WALL BOX 14X14	LEGRAND	WMPAC526FCWP4	66"	FLUSH	PROVIDE			ELECTRICAL RECEPTACLES AND DATA PORTS SHALL RESIDE IN THIS BOX. REFER TO ELECTRICAL AND TELECOMMUNICATIONS DRAWINGS FOR CIRCUITING AND PORT COUNT REQUIREMENTS.
V.1400-01	FLAT PANEL DISPLAY WALL BOX	FLUSH WALL BOX 14X14	LEGRAND	WMPAC526FCWP4	79"	FLUSH	PROVIDE			ELECTRICAL RECEPTACLES AND DATA PORTS SHALL RESIDE IN THIS BOX. REFER TO ELECTRICAL AND TELECOMMUNICATIONS DRAWINGS FOR CIRCUITING AND PORT COUNT REQUIREMENTS.
V.1400-02	ASSORTED CONNECTION WALL BOX	FLUSH WALL BOX 14X14	LEGRAND	WMPAC526FCWP4	79"	FLUSH	PROVIDE			PROVIDE ONE LEGRAND WMPACL2 ATTACHMENT PLATE
V.1400-03	FLAT PANEL DISPLAY WALL BOX	FLUSH WALL BOX 14X14	LEGRAND	WMPAC526FCWP4	64"	FLUSH	PROVIDE			NONE
V.1400-04	FLAT PANEL DISPLAY WALL BOX	FLUSH WALL BOX 14X14	LEGRAND	WMPAC526FCWP4	64"	FLUSH	PROVIDE			NONE
V.1400-05	FLAT PANEL DISPLAY WALL BOX	FLUSH WALL BOX 14X14	LEGRAND	WMPAC526FCWP4	64"	FLUSH	PROVIDE			ELECTRICAL RECEPTACLES AND DATA PORTS SHALL RESIDE IN THIS BOX. REFER TO ELECTRICAL AND TELECOMMUNICATIONS DRAWINGS FOR CIRCUITING AND PORT COUNT REQUIREMENTS.
V.1400-06	FLAT PANEL DISPLAY WALL BOX	FLUSH WALL BOX 14X14	LEGRAND	WMPAC526FCWP4	64"	FLUSH	PROVIDE			NONE
V.1400-07	FLAT PANEL DISPLAY WALL BOX	FLUSH WALL BOX 14X14	LEGRAND	WMPAC526FCWP4	64"	FLUSH	PROVIDE			NONE
V.1400-08	FLAT PANEL DISPLAY WALL BOX	FLUSH WALL BOX 14X14	LEGRAND	WMPAC526FCWP4	64"	FLUSH	PROVIDE			NONE
V.1400-09	LAPTOP OR VIDEO CONNECTION FLOOR BOX	FLOOR BOX 10x12x06	FSR	FI-500P-6-B	0"	FLOOR FLUSH	SOLID COVER, NO FLANGE, HINGED			PROVIDE
V.1410-01	FLAT PANEL DISPLAY WALL BOX	FLUSH WALL BOX 14X14	LEGRAND	WMPAC526FCWP4	85"	FLUSH	PROVIDE			ELECTRICAL RECEPTACLES AND DATA PORTS SHALL RESIDE IN THIS BOX. REFER TO ELECTRICAL AND TELECOMMUNICATIONS DRAWINGS FOR CIRCUITING AND PORT COUNT REQUIREMENTS.
V.1410-02	FLAT PANEL DISPLAY WALL BOX	FLUSH WALL BOX 14X14	LEGRAND	WMPAC526FCWP4	85"	FLUSH	PROVIDE			ELECTRICAL RECEPTACLES AND DATA PORTS SHALL RESIDE IN THIS BOX. REFER TO ELECTRICAL AND TELECOMMUNICATIONS DRAWINGS FOR CIRCUITING AND PORT COUNT REQUIREMENTS.
V.1504-01	FLAT PANEL DISPLAY WALL BOX	FLUSH WALL BOX 14X14	LEGRAND	WMPAC526FCWP4	60"	FLUSH	PROVIDE			NONE
V.1526-01	FLAT PANEL DISPLAY WALL BOX	FLUSH WALL BOX 14X14	LEGRAND	WMPAC526FCWP4	60"	FLUSH	PROVIDE			NONE
V.1602-01	FLAT PANEL DISPLAY WALL BOX	FLUSH WALL BOX 14X14	LEGRAND	WMPAC526FCWP4	85"	FLUSH	PROVIDE			PROVIDE ONE LEGRAND WMPACL2 ATTACHMENT PLATE
V.1603-01	FLAT PANEL DISPLAY WALL BOX	FLUSH WALL BOX 14X14	LEGRAND	WMPAC526FCWP4	85"	FLUSH	PROVIDE			PROVIDE ONE LEGRAND WMPACL2 ATTACHMENT PLATE
V.1616-01	ASSORTED CONNECTION WALL BOX	FLUSH WALL BOX 14X14	LEGRAND	WMPAC526FCWP4	60"	FLUSH	PROVIDE			PROVIDE ONE LEGRAND WMPACL2 ATTACHMENT PLATE
V.1616-02	ASSORTED CONNECTION WALL BOX	2-GANG/1-GANG	RACO	260 W/ 843	30"	FLUSH	BLANK			1-GANG MUD RING
V.1616-03	ASSORTED CONNECTION WALL BOX	FLUSH WALL BOX 14X14	LEGRAND	WMPAC526FCWP4	60"	FLUSH	PROVIDE			PROVIDE ONE LEGRAND WMPACL2 ATTACHMENT PLATE
V.1616-04	ASSORTED CONNECTION WALL BOX	2-GANG/1-GANG	RACO	260 W/ 843	30"	FLUSH	BLANK			1-GANG MUD RING
V.1616-05	ASSORTED CONNECTION WALL BOX	2-GANG/1-GANG	RACO	260 W/ 843	30"	FLUSH	BLANK			1-GANG MUD RING
V.1616-06	ASSORTED CONNECTION WALL BOX	2-GANG/1-GANG	RACO	260 W/ 843	30"	FLUSH	BLANK			1-GANG MUD RING
V.1616-07	ASSORTED CONNECTION WALL BOX	FLUSH WALL BOX 14X14	LEGRAND	WMPAC526FCWP4	60"	FLUSH	PROVIDE			PROVIDE ONE LEGRAND WMPACL2 ATTACHMENT PLATE
V.1616-08	ASSORTED CONNECTION WALL BOX	2-GANG/1-GANG	RACO	260 W/ 843	30"	FLUSH	PROVIDE			1-GANG MUD RING
V.1616-09	ASSORTED CONNECTION WALL BOX	FLUSH WALL BOX 14X14	LEGRAND	WMPAC526FCWP4	60"	FLUSH	PROVIDE			PROVIDE ONE LEGRAND WMPACL2 ATTACHMENT PLATE
V.1616-10	ASSORTED CONNECTION WALL BOX	2-GANG/1-GANG	RACO	260 W/ 843	30"	FLUSH	BLANK			1-GANG MUD RING
V.1616-11	ASSORTED CONNECTION WALL BOX	FLUSH WALL BOX 14X14	LEGRAND	WMPAC526FCWP4	60"	FLUSH	PROVIDE			PROVIDE ONE LEGRAND WMPACL2 ATTACHMENT PLATE
V.1616-12	ASSORTED CONNECTION WALL BOX	2-GANG/1-GANG	RACO	260 W/ 843	30"	FLUSH	BLANK			1-GANG MUD RING
V.1616-13	ASSORTED CONNECTION WALL BOX	FLUSH WALL BOX 14X14	LEGRAND	WMPAC526FCWP4	60"	FLUSH	PROVIDE			PROVIDE ONE LEGRAND WMPACL2 ATTACHMENT PLATE

BOX FUNCTION		BOX PROPERTIES					BOX ACCESSORIES			NOTES
ID	DESCRIPTION	TYPE	B.O.D. MANUF.	B.O.D. MODEL	INSTALL HEIGHT (CENTER OF BOX)	MOUNTING	COVER	INSERTS		
K.1306.01	ASSORTED CONNECTION WALL BOX	2-GANG/1-GANG	RACO	260 W/ 843	90"	FLUSH	BLANK	1-GANG MUD RING		
K.1308.01	ASSORTED CONNECTION WALL BOX	2-GANG/1-GANG	RACO	260 W/ 843	90"	FLUSH	BLANK	1-GANG MUD RING		
K.1312.01	ASSORTED CONNECTION WALL BOX	2-GANG/1-GANG	RACO	260 W/ 843	90"	FLUSH	BLANK	1-GANG MUD RING		
K.1400.01	CAMERA CONNECTION CEILING BOX	1-GANG	RACO	256 W/ 768	0"	CEILING FLUSH	BLANK	1-GANG MUD RING		
K.1400.02	CAMERA CONNECTION WALL BOX	2-GANG/1-GANG	RACO	260 W/ 843	75"	FLUSH	BLANK	1-GANG MUD RING		
K.1400.03	CAMERA CONNECTION WALL BOX	1-GANG	RACO	256 W/ 768	0"	CEILING FLUSH	BLANK	1-GANG MUD RING		
K.1400.04	CAMERA CONNECTION WALL BOX	1-GANG	RACO	256 W/ 768	0"	CEILING FLUSH	BLANK	1-GANG MUD RING		
K.1400.05	CAMERA CONNECTION WALL BOX	1-GANG	RACO	256 W/ 768	0"	CEILING FLUSH	BLANK	1-GANG MUD RING		
K.1400.06	CAMERA CONNECTION WALL BOX	1-GANG	RACO	256 W/ 768	0"	CEILING FLUSH	BLANK	1-GANG MUD RING		
K.1400.07	CAMERA CONNECTION WALL BOX	1-GANG	RACO	256 W/ 768	0"	CEILING FLUSH	BLANK	1-GANG MUD RING		
K.1400.08	CAMERA CONNECTION WALL BOX	1-GANG	RACO	256 W/ 768	0"	CEILING FLUSH	BLANK	1-GANG MUD RING		
K.1504.01	ASSORTED CONNECTION WALL BOX	2-GANG/1-GANG	RACO	260 W/ 843	90"	FLUSH	BLANK	1-GANG MUD RING		
K.1644.01	CAMERA CONNECTION WALL BOX	2-GANG/1-GANG	RACO	260 W/ 843	84"	FLUSH	BLANK	1-GANG MUD RING		
K.1646.01	ASSORTED CONNECTION WALL BOX	2-GANG/1-GANG	RACO	260 W/ 843	90"	FLUSH	BLANK	1-GANG MUD RING		
K.2210.01	ASSORTED CONNECTION WALL BOX	2-GANG/1-GANG	RACO	260 W/ 843	90"	FLUSH	BLANK	1-GANG MUD RING		
K.2212.01	ASSORTED CONNECTION WALL BOX	2-GANG/1-GANG	RACO	260 W/ 843	90"	FLUSH	BLANK	1-GANG MUD RING		
K.2214.01	ASSORTED CONNECTION WALL BOX	2-GANG/1-GANG	RACO	260 W/ 843	90"	FLUSH	BLANK	1-GANG MUD RING		
K.2216.01	ASSORTED CONNECTION WALL BOX	2-GANG/1-GANG	RACO	260 W/ 843	90"	FLUSH	BLANK	1-GANG MUD RING		
K.2218.01	ASSORTED CONNECTION WALL BOX	2-GANG/1-GANG	RACO	260 W/ 843	90"	FLUSH	BLANK	1-GANG MUD RING		
K.2220.01	ASSORTED CONNECTION WALL BOX	2-GANG/1-GANG	RACO	260 W/ 843	90"	FLUSH	BLANK	1-GANG MUD RING		
K.2222.01	CAMERA CONNECTION WALL BOX	2-GANG/1-GANG	RACO	260 W/ 843	84"	FLUSH	BLANK	1-GANG MUD RING		
K.2222.01	ASSORTED CONNECTION WALL BOX	2-GANG/1-GANG	RACO	260 W/ 843	90"	FLUSH	BLANK	1-GANG MUD RING		
K.2224.01	ASSORTED CONNECTION WALL BOX	2-GANG/1-GANG	RACO	260 W/ 843	84"	FLUSH	BLANK	1-GANG MUD RING		
K.2224.01	ASSORTED CONNECTION WALL BOX	2-GANG/1-GANG	RACO	260 W/ 843	90"	FLUSH	BLANK	1-GANG MUD RING		
K.2400.01	CAMERA CONNECTION CEILING BOX	1-GANG	RACO	256 W/ 768	0"	CEILING FLUSH	BLANK	1-GANG MUD RING		
K.2400.02	CAMERA CONNECTION CEILING BOX	1-GANG	RACO	256 W/ 768	0"	CEILING FLUSH	BLANK	1-GANG MUD RING		
K.2401.01	CAMERA CONNECTION CEILING BOX	1-GANG	RACO	256 W/ 768	0"	CEILING FLUSH	BLANK	1-GANG MUD RING		
K.2401.02	CAMERA CONNECTION CEILING BOX	1-GANG	RACO	256 W/ 768	0"	CEILING FLUSH	BLANK	1-GANG MUD RING		
K.3126.01	ASSORTED CONNECTION CEILING BOX	1-GANG	RACO	256 W/ 768	0"	CEILING FLUSH	BLANK	NONE		
K.3138.01	ASSORTED CONNECTION WALL BOX	2-GANG/1-GANG	RACO	260 W/ 843	90"	FLUSH	BLANK	1-GANG MUD RING		
K.3148.01	ASSORTED CONNECTION WALL BOX	2-GANG/1-GANG	RACO	260 W/ 843	90"	FLUSH	BLANK	1-GANG MUD RING		
K.3150.01	ASSORTED CONNECTION WALL BOX	2-GANG/1-GANG	RACO	260 W/ 843	90"	FLUSH	BLANK	1-GANG MUD RING		
K.3402.01	ASSORTED CONNECTION WALL BOX	2-GANG/1-GANG	RACO	260 W/ 843	90"	FLUSH	BLANK	1-GANG MUD RING		
K.3404.01	ASSORTED CONNECTION WALL BOX	2-GANG/1-GANG	RACO	260 W/ 843	90"	FLUSH	BLANK	1-GANG MUD RING		
K.3406.01	ASSORTED CONNECTION WALL BOX	2-GANG/1-GANG	RACO	260 W/ 843	90"	FLUSH	BLANK	1-GANG MUD RING		
K.4118.01	ASSORTED CONNECTION CEILING BOX	1-GANG	RACO	256 W/ 768	0"	CEILING FLUSH	BLANK	NONE		
K.4130.01	ASSORTED CONNECTION CEILING BOX	1-GANG	RACO	256 W/ 768	0"	CEILING FLUSH	BLANK	NONE		
M.1306.01	FLUSH CEILING MICROPHONE	CEILING MICROPHONE ARRAY - USB	CLEARONE	COLLABORATE VERSA LITE CT	0"	CEILING FLUSH	NONE	NONE		
M.1308.01	FLUSH CEILING MICROPHONE	CEILING MICROPHONE ARRAY - USB	CLEARONE	COLLABORATE VERSA LITE CT	0"	CEILING FLUSH	NONE	NONE		
M.1312.01	FLUSH CEILING MICROPHONE	CEILING MICROPHONE ARRAY - USB	CLEARONE	COLLABORATE VERSA LITE CT	0"	CEILING FLUSH	NONE	NONE		
M.1400.01	MICROPHONE CONNECTION CEILING BOX	1-GANG	RACO	256 W/ 768	0"	CEILING FLUSH	BLANK	NONE		
M.1504.01	FLUSH CEILING MICROPHONE	CEILING MICROPHONE ARRAY - USB	CLEARONE	COLLABORATE VERSA LITE CT	0"	CEILING FLUSH	NONE	NONE		
M.1646.01	FLUSH CEILING MICROPHONE	CEILING MICROPHONE ARRAY - USB	CLEARONE	COLLABORATE VERSA LITE CT	0"	CEILING FLUSH	NONE	NONE		
M.2210.01	FLUSH CEILING MICROPHONE	CEILING MICROPHONE ARRAY - USB	CLEARONE	COLLABORATE VERSA LITE CT	0"	CEILING FLUSH	NONE	NONE		
M.2210.01	FLUSH CEILING MICROPHONE	CEILING MICROPHONE ARRAY - USB	CLEARONE	COLLABORATE VERSA LITE CT	0"	CEILING FLUSH	NONE	NONE		
M.2210.01	FLUSH CEILING MICROPHONE	CEILING MICROPHONE ARRAY - USB	CLEARONE	COLLABORATE VERSA LITE CT	0"	CEILING FLUSH	NONE	NONE		
M.2210.01	FLUSH CEILING MICROPHONE	CEILING MICROPHONE ARRAY - USB	CLEARONE	COLLABORATE VERSA LITE CT	0"	CEILING FLUSH	NONE	NONE		
M.2220.01	FLUSH CEILING MICROPHONE	CEILING MICROPHONE ARRAY - USB	CLEARONE	COLLABORATE VERSA LITE CT	0"	CEILING FLUSH	NONE	NONE		
M.2222.01	FLUSH CEILING MICROPHONE	CEILING MICROPHONE ARRAY - USB	CLEARONE	COLLABORATE VERSA LITE CT	0"	CEILING FLUSH	NONE	NONE		
M.2224.01	FLUSH CEILING MICROPHONE	CEILING MICROPHONE ARRAY - USB	CLEARONE	COLLABORATE VERSA LITE CT	0"	CEILING FLUSH	NONE	NONE		
M.3126.01	FLUSH CEILING MICROPHONE	CEILING MICROPHONE ARRAY - USB	CLEARONE	COLLABORATE VERSA LITE CT	0"	CEILING FLUSH	NONE	NONE		
M.3138.01	FLUSH CEILING MICROPHONE	CEILING MICROPHONE ARRAY - USB	CLEARONE	COLLABORATE VERSA LITE CT	0"	CEILING FLUSH	NONE	NONE		
M.3148.01	FLUSH CEILING MICROPHONE	CEILING MICROPHONE ARRAY - USB	CLEARONE	COLLABORATE VERSA LITE CT	0"	CEILING FLUSH	NONE	NONE		
M.3150.01	FLUSH CEILING MICROPHONE	CEILING MICROPHONE ARRAY - USB	CLEARONE	COLLABORATE VERSA LITE CT	0"	CEILING FLUSH	NONE	NONE		
M.3402.01	FLUSH CEILING MICROPHONE	CEILING MICROPHONE ARRAY - USB	CLEARONE	COLLABORATE VERSA LITE CT	0"	CEILING FLUSH	NONE	NONE		
M.3404.01	FLUSH CEILING MICROPHONE	CEILING MICROPHONE ARRAY - USB	CLEARONE	COLLABORATE VERSA LITE CT	0"	CEILING FLUSH	NONE	NONE		
M.3406.01	FLUSH CEILING MICROPHONE	CEILING MICROPHONE ARRAY - USB	CLEARONE	COLLABORATE VERSA LITE CT	0"	CEILING FLUSH	NONE	NONE		
M.4118.01	FLUSH CEILING MICROPHONE	CEILING MICROPHONE ARRAY - USB	CLEARONE	COLLABORATE VERSA LITE CT	0"	CEILING FLUSH	NONE	NONE		
M.4130.01	FLUSH CEILING MICROPHONE	CEILING MICROPHONE ARRAY - USB	CLEARONE	COLLABORATE VERSA LITE CT	0"	CEILING FLUSH	NONE	NONE		

NEW SHEET

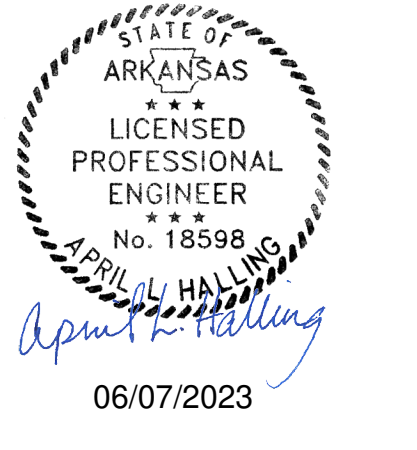

REVISIONS		
NUMBER	DATE	DESCRIPTION
2	06/23	Addendum 2



REVISIONS		
NUMBER	DATE	DESCRIPTION
1	03/10/23	Addendum 1
2	06/29/23	Addendum 2

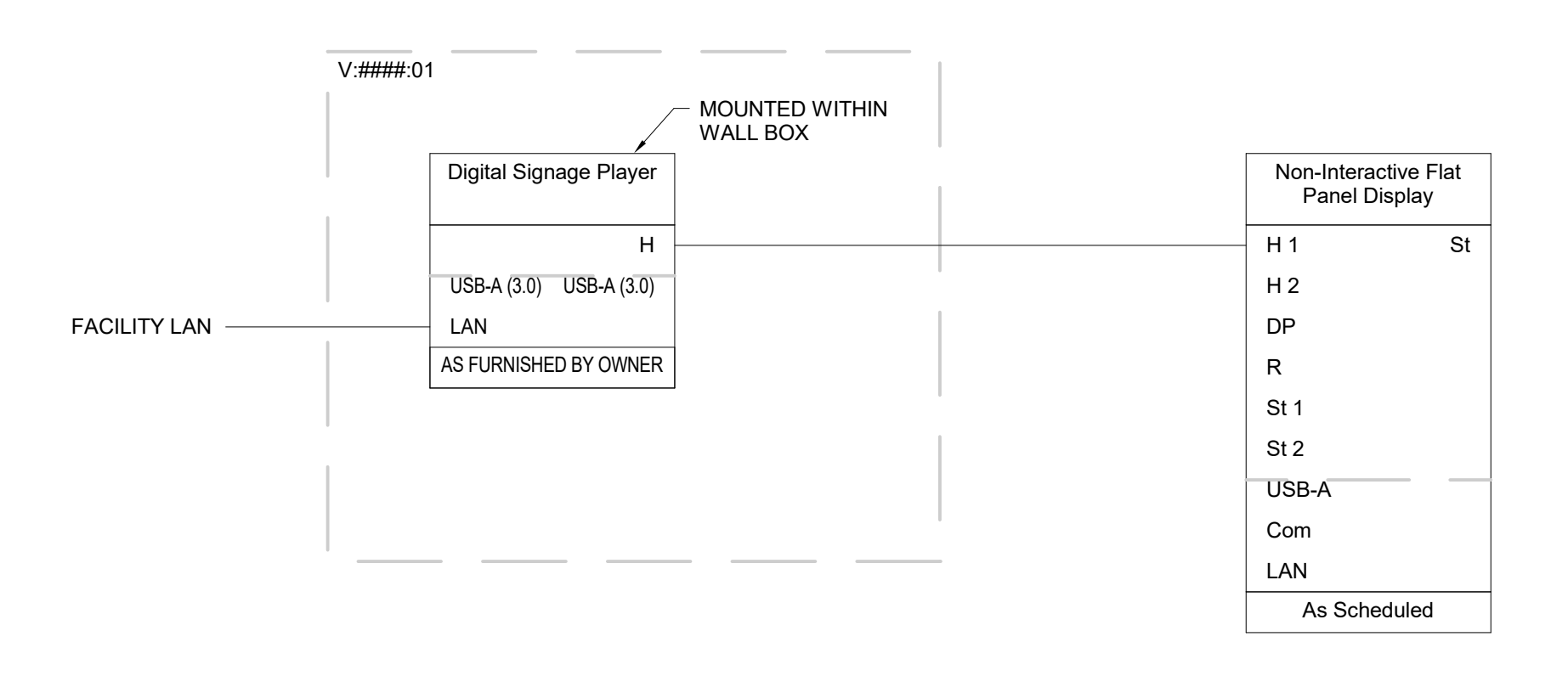

1 SIGNAL FLOW DIAGRAM FOR NON-INTERACTIVE DIGITAL SIGNAGE
CAFE DINING, GAME ROOMS, PUBLIC LOBBIES, STUDENT LOUNGES, CLINIC WAITING, GYMNASIUM

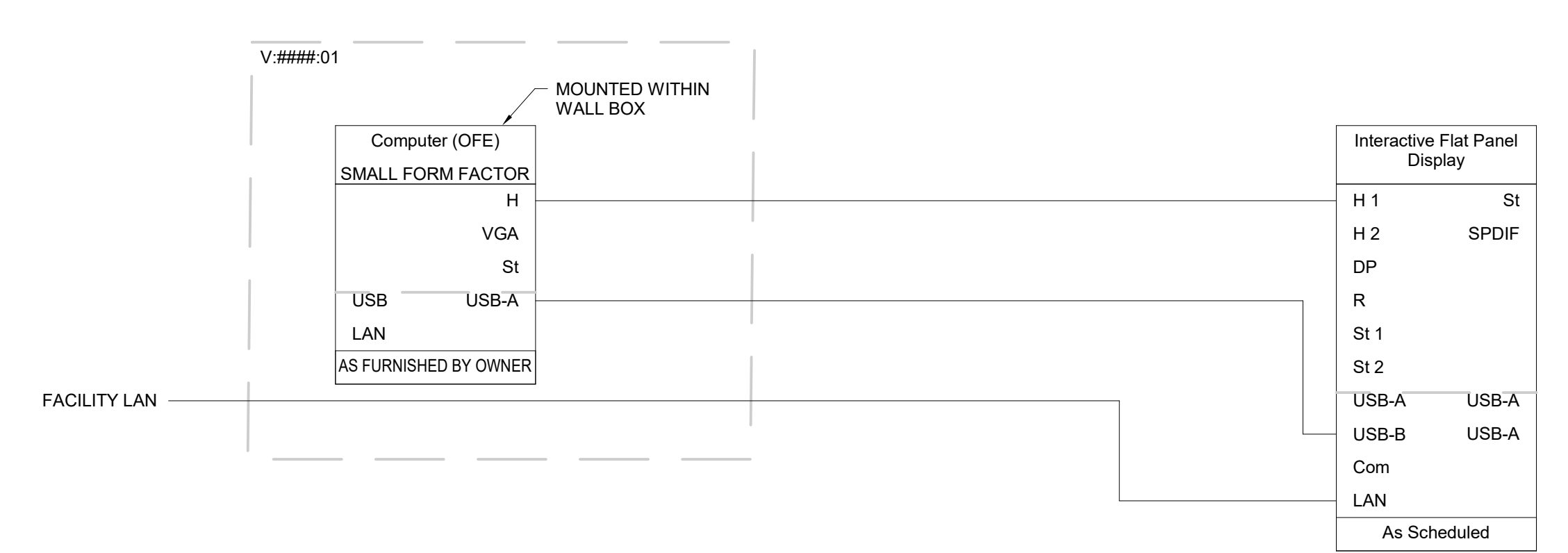

2 SIGNAL FLOW DIAGRAM FOR SECURITY
SECURITY OFFICE 1528

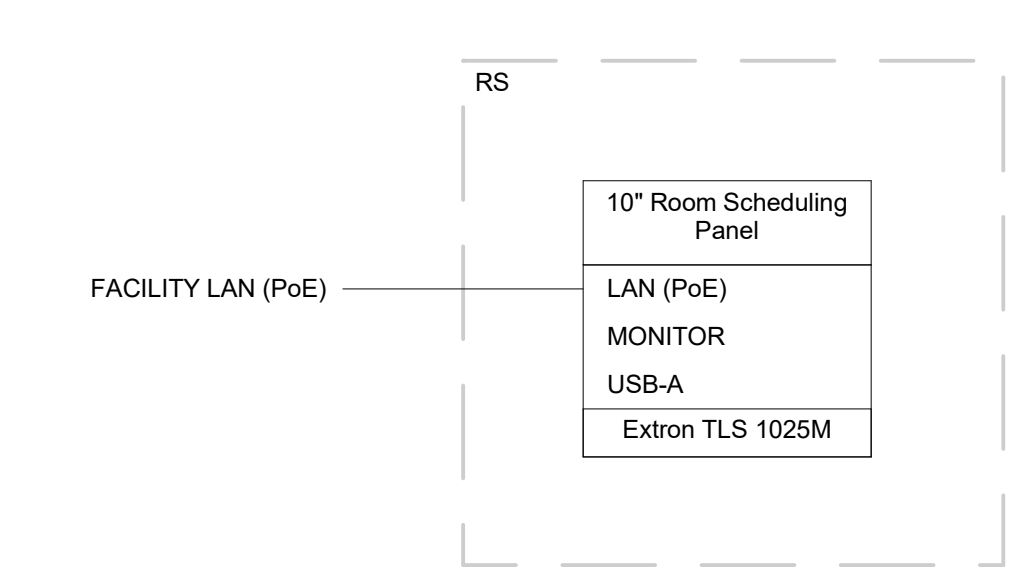

3 SIGNAL FLOW DIAGRAM FOR ROOM SCHEDULING
TYPICAL ALL ROOM SCHEDULING PANEL LOCATIONS

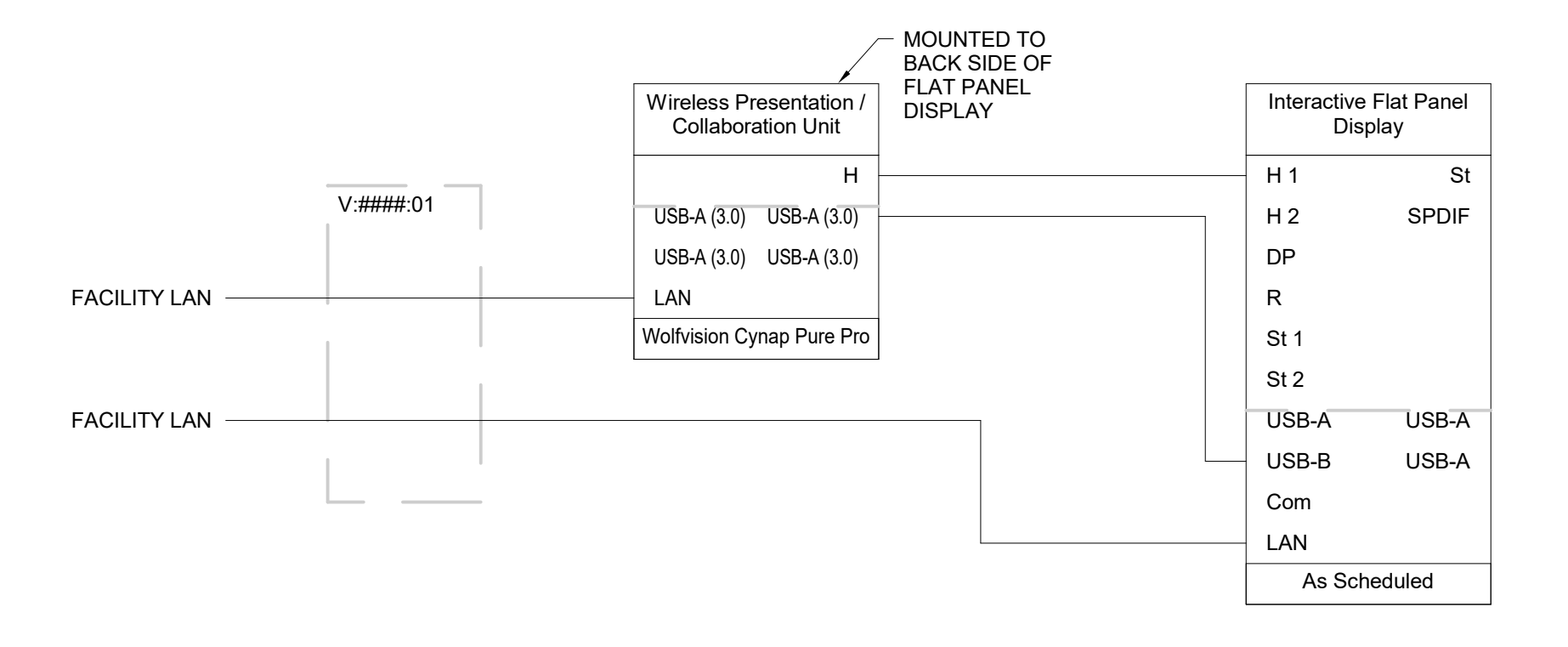

4 SIGNAL FLOW DIAGRAM FOR OPEN GATHERING SPACES
GENERAL CORRIDORS, SITTING AREAS, LIBRARY, BREAK ROOMS, WELLNESS STUDIO 3318, STUDENT RECREATION 3310, & OFFICE 4142

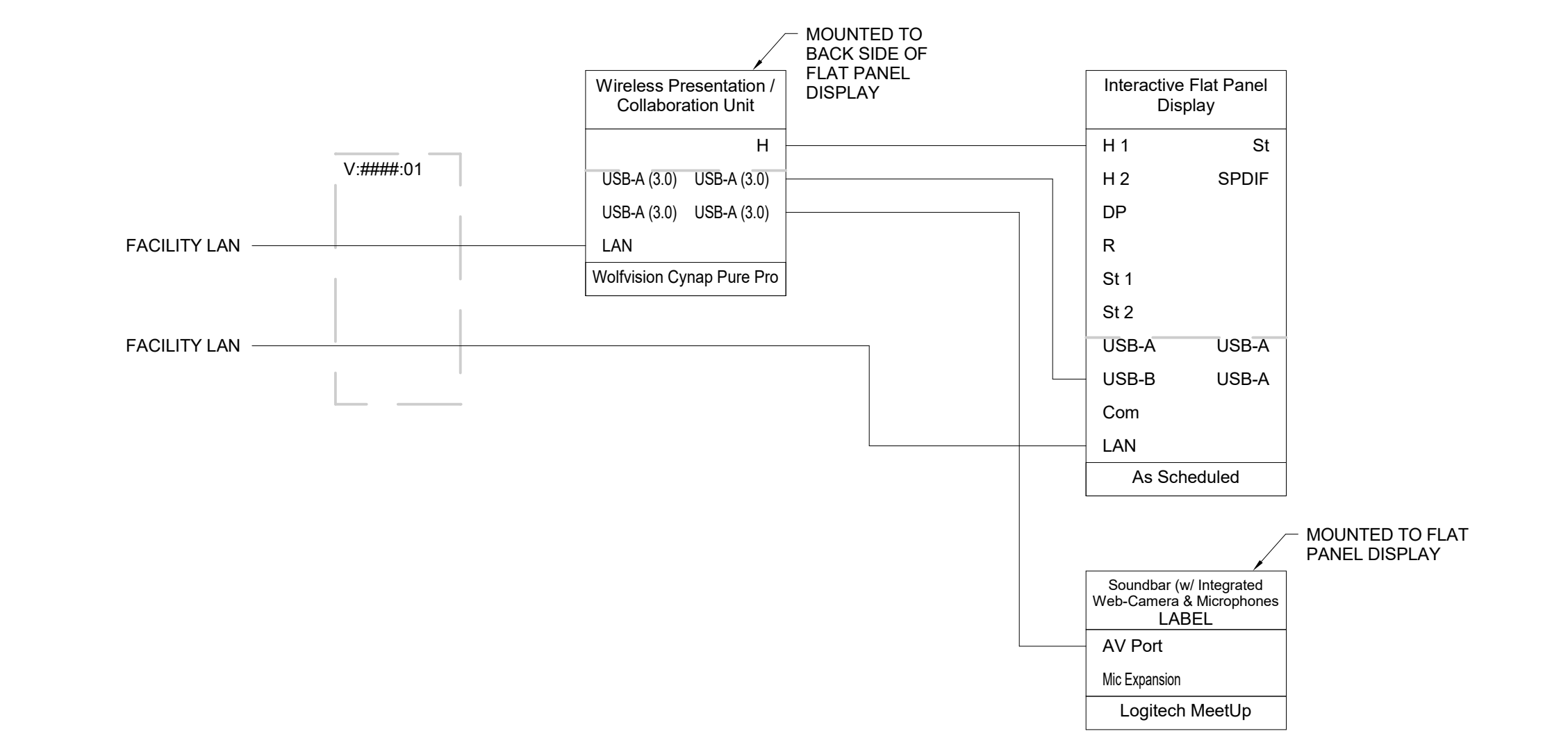

5 SIGNAL FLOW DIAGRAM FOR STUDY SPACES
STUDY ROOMS

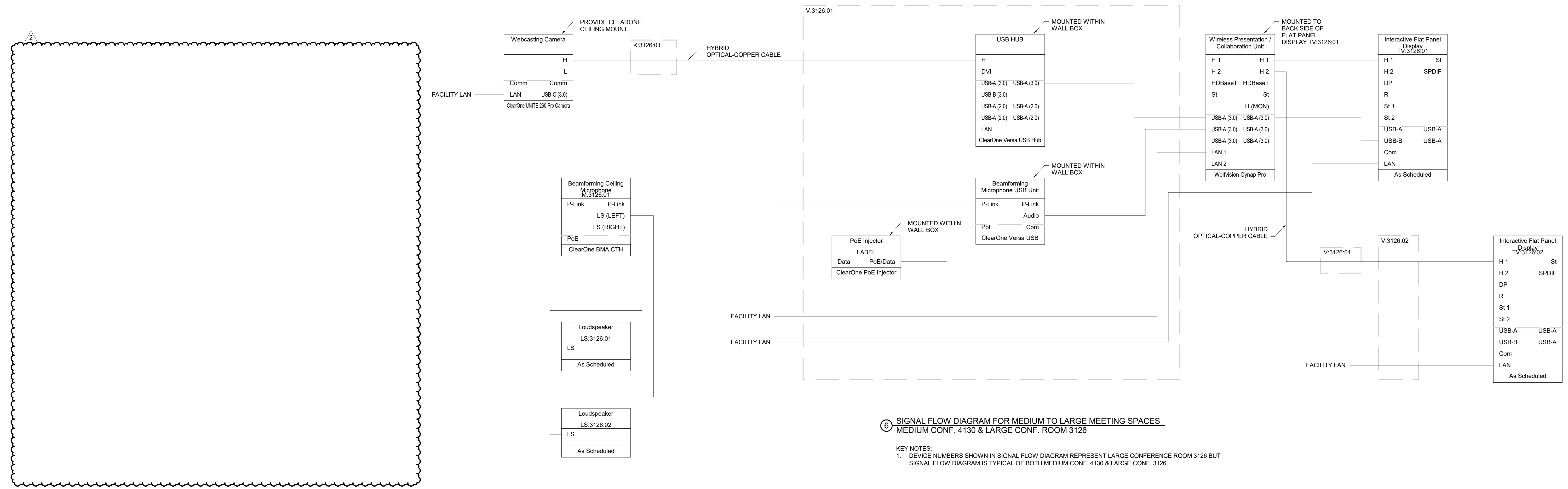

6 SIGNAL FLOW DIAGRAM FOR MEDIUM TO LARGE MEETING SPACES
MEDIUM CONF. 4130 & LARGE CONF. ROOM 3126

KEY NOTES:
1. DEVICE NUMBERS SHOWN IN SIGNAL FLOW DIAGRAM REPRESENT LARGE CONFERENCE ROOM 3126 BUT SIGNAL FLOW DIAGRAM IS TYPICAL OF BOTH MEDIUM CONF. 4130 & LARGE CONF. 3126.

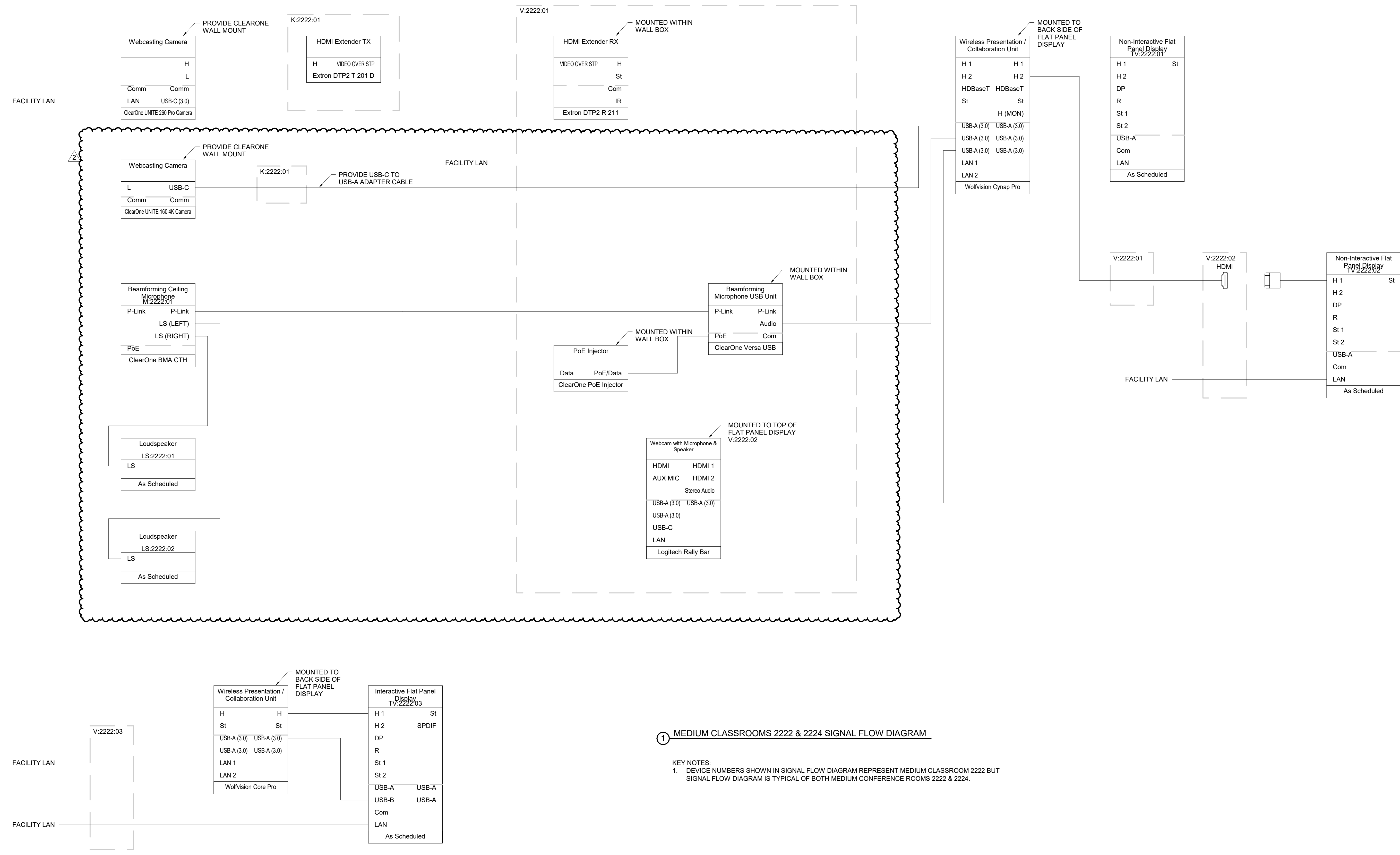

1 MEDIUM CLASSROOMS 2222 & 2224 SIGNAL FLOW DIAGRAM

KEY NOTES:
1. DEVICE NUMBERS SHOWN IN SIGNAL FLOW DIAGRAM REPRESENT MEDIUM CLASSROOM 2222 BUT SIGNAL FLOW DIAGRAM IS TYPICAL OF BOTH MEDIUM CONFERENCE ROOMS 2222 & 2224.

PSW Job Number:
993A

Henderson Job Number:
2150002607

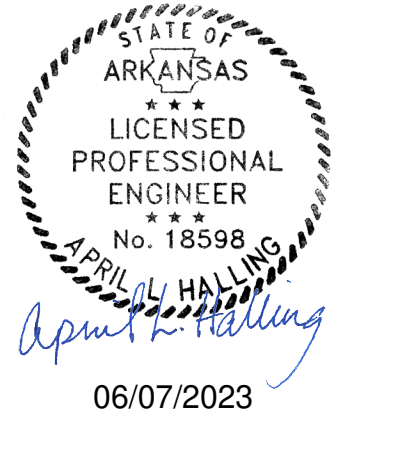

AWSOM
Bentonville, AR

Issue Date:
02.24.2023

REVISIONS		
NUMBER	DATE	DESCRIPTION
2	06/23	Addendum 2

Contents:
**AUDIO-VIDEO
SIGNAL FLOWS**

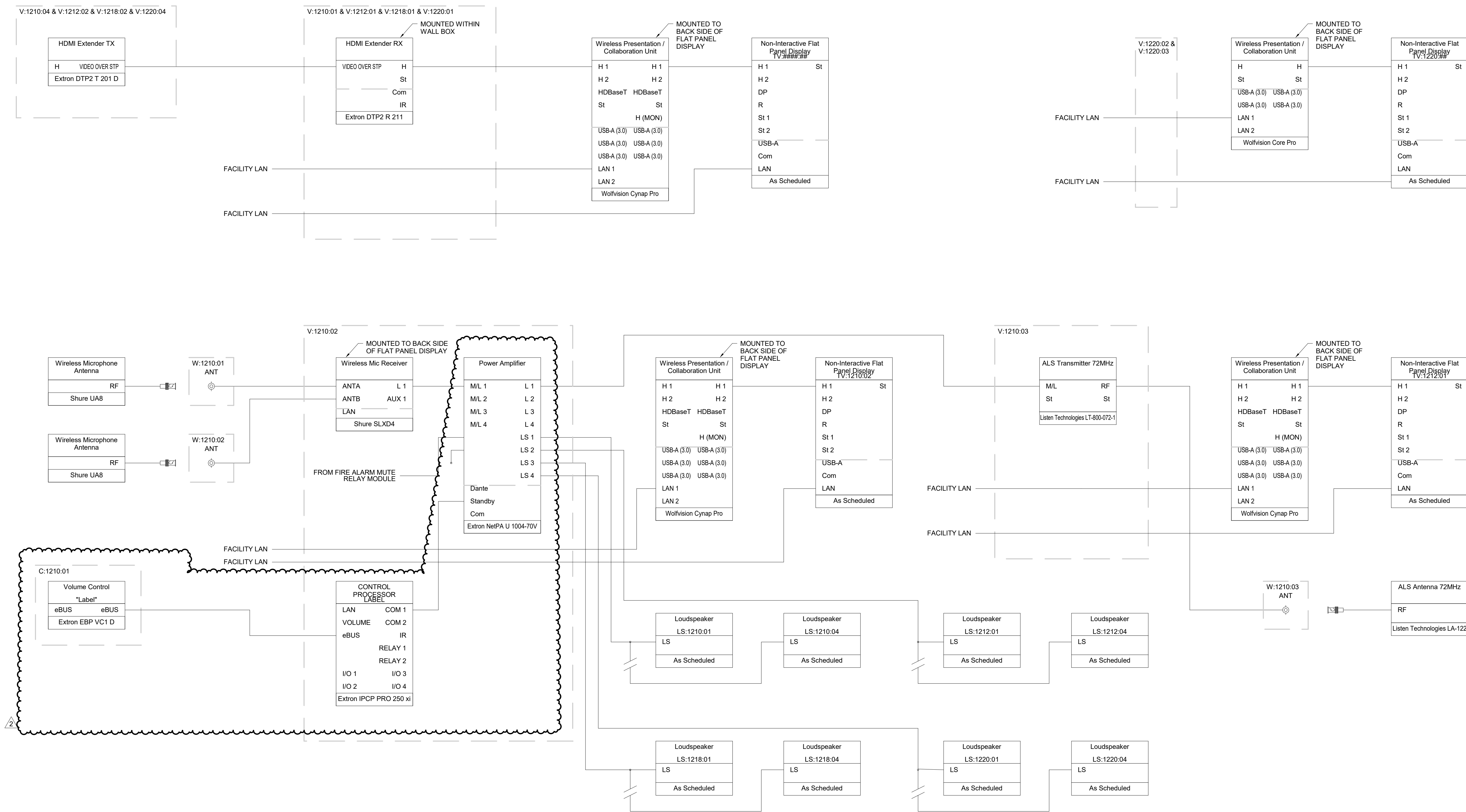

1 DEBRIEF / CLINICAL SKILLS 1210, 1212, 1218 & 1220 SIGNAL FLOW DIAGRAM

PSW Job Number:
993A
 Henderson Job Number:
2150002607

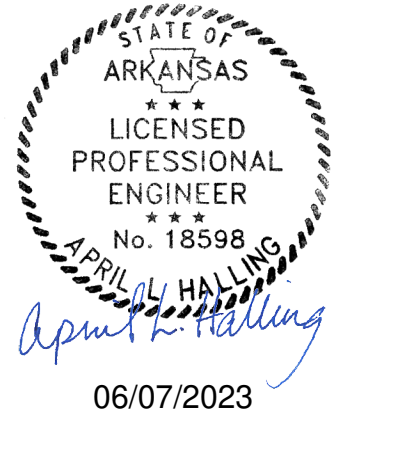

AWSOM
 Bentonville, AR

Issue Date:
03/09/23

NUMBER	DATE	DESCRIPTION
1	06/23	ADDENDUM 2

Contents:
AUDIO-VIDEO SIGNAL FLOWS

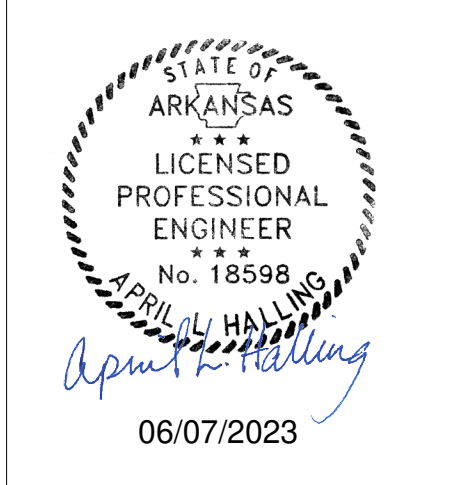

REVISIONS		
NUMBER	DATE	DESCRIPTION
2	06/23	Addendum 2

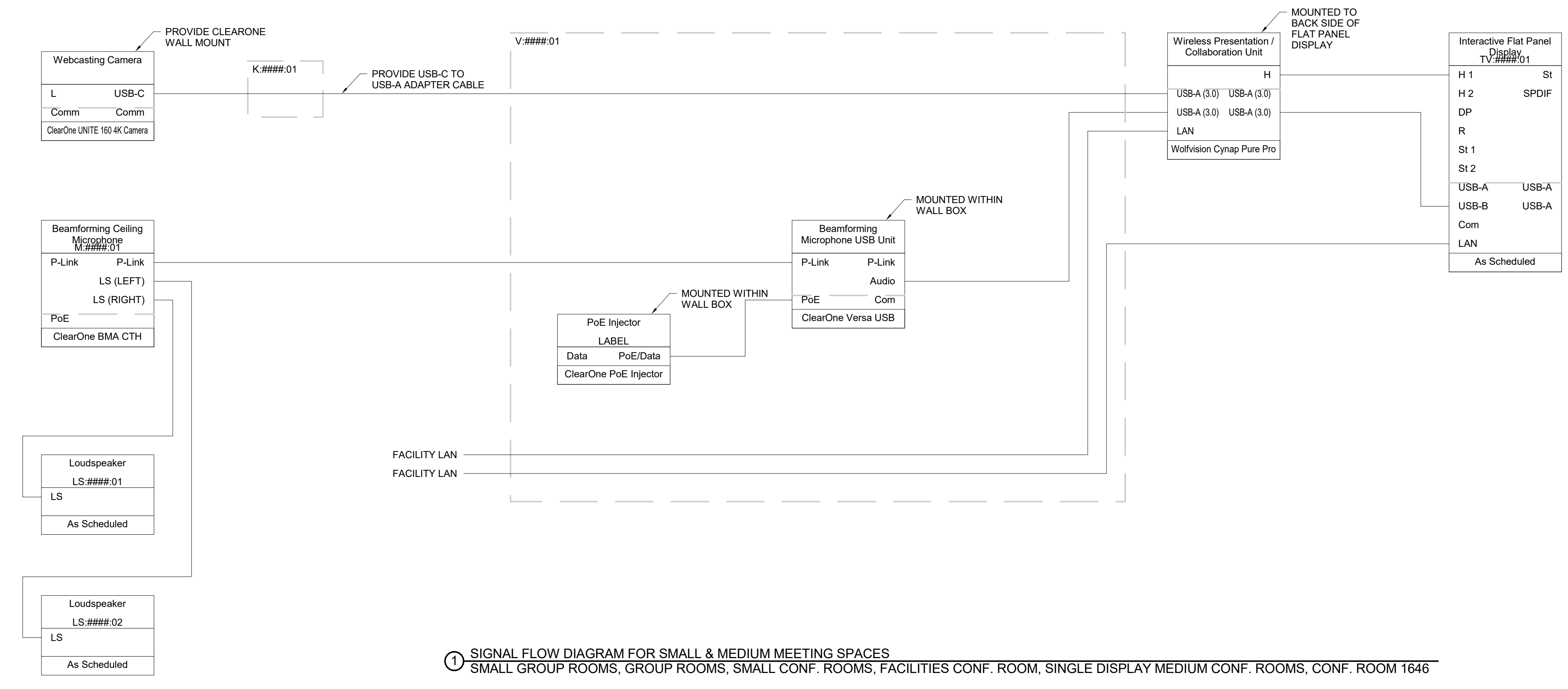

NEW SHEET